



APPLICATIONS

- Bars
- Pubs
- Restaurants
- Retail shops
- Clubs
- Entertainment venues
- Fitness centres
- Conference rooms
- Theatres
- Houses of worship
- Exhibition centres

KEY FEATURES

- 2-way passive sound reinforcement system
- 0.47" baltic birch plywood cabinet
- 1 x 8" custom made LF woofer with rubber surround
- 1 x 1.5" HF dome tweeter
- 175W continuous pink noise
- 350W continuous program
- 700W peak
- Optional line transformer (100V / 100W)
- Multiple M5 threaded rigging points
- Crossover networks equipped with 4 x Euroblock speaker terminals
- Choice of different RAL paint colours
- Choice of different paint finish
- Completely manufactured in Italy

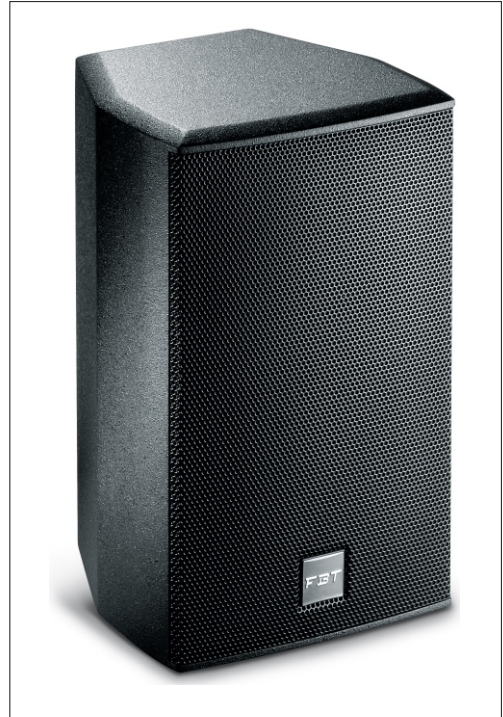

Designed, Engineered
and Manufactured in ITALY

PRODUCT DESCRIPTION

The loudspeaker shall consist of a 8" low frequency transducer, 1.5" HF dome tweeter; the low frequency driver's voice coil shall be 1.5" in diameter. Performance specifications of a typical unit shall be as follows: usable frequency response shall extend from 55Hz to 22kHz; nominal impedance shall be 8 ohms; the frequency dividing network shall have a crossover frequency of 2 kHz; measured sensitivity shall be at least 92.5dB (at 1m [3.3ft]). The input shall be switchable for use either at nominal 8 ohms or on a 100V distributed speaker line via transformer (optional). The cabinet shall be constructed of 0.47" Baltic birch plywood covered in a scratch & scuff resistant black or white finish. ARCHON speakers shall be installed in suspension by wall bracket, on tripod stand, with adjustable wall support and simple stack installation.

ELECTRONIC SPECIFICATIONS

System Type	2 Way
Recommended Amplifier	350W RMS
System Long Term Power	175W
System Short Term Power (IEC 268-5)	700W
Transformer (optional)	100V / 100W
Nominal Impedance	8 Ohm
Frequency Response	55Hz - 22kHz (@-6dB)
Sensitivity	92.5dB (@1W, 1m)
Max SPL (cont/peak) (bi-amp)*	118dB / 121dB
Dispersion	90°
Crossover Frequency	2kHz
Recommended HP Filter	40Hz - 24dB oct.

PHYSICAL SPECIFICATIONS

Low Frequency Woofer	8" / 1.5" coil
High Frequency Driver	1.5" / 1.5" coil
Input Connectors	Euroblock (4 pin)
Net Dimensions (WxHxD) inch	9.76 x 16.18 x 9.76
Shipping Dimensions (WxHxD) inch	12.99 x 19.33 x 12.99
Net Weight	14.3 lbs
Shipping Weight	18.7 lbs
Enclosure Material	0.47" baltic plywood
Grille	Steel with powder coat black or white paint finish

* CONT. SPL: free space, based on recommended amp rating and LF transducer average sensitivity data, 125mS time average
PEAK SPL: free space, based on short term applicable power rating and system peak sensitivity, 10mS time average



DIAGRAMS

Horizontal polar diagrams

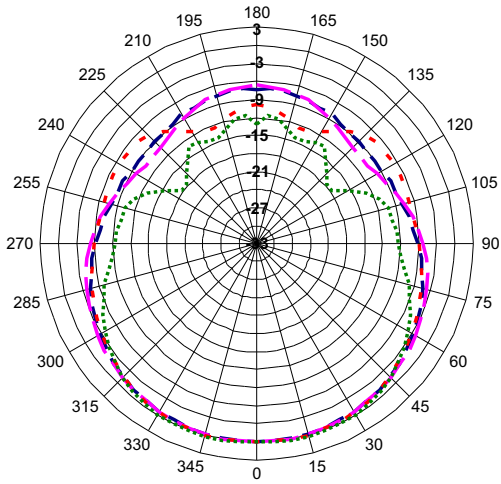

Horizontal polar diagrams

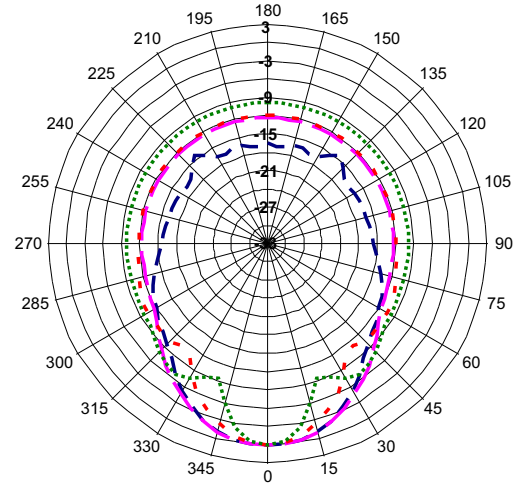

FREQUENCY RESPONSE

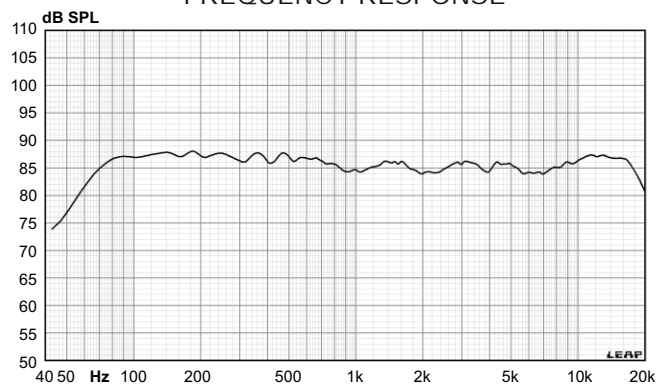



DIAGRAMS

axis normalized vertical polar diagrams

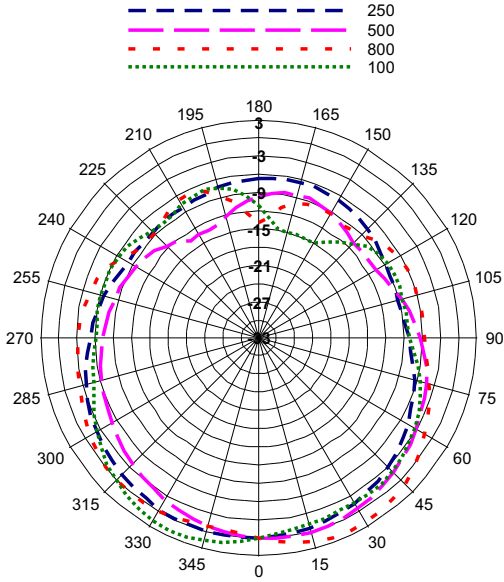

axis normalized vertical polar diagrams

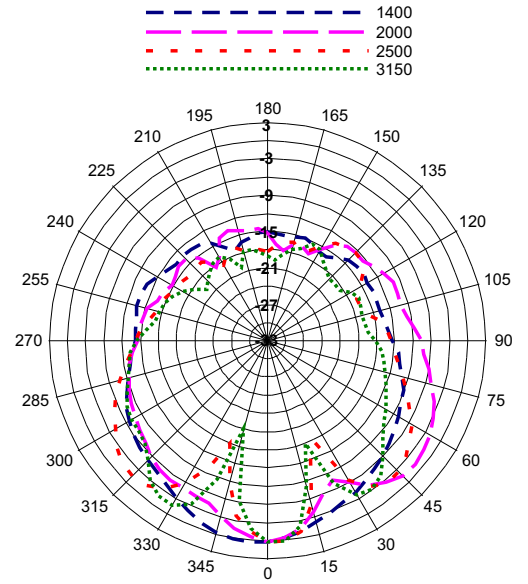

axis normalized vertical polar diagrams

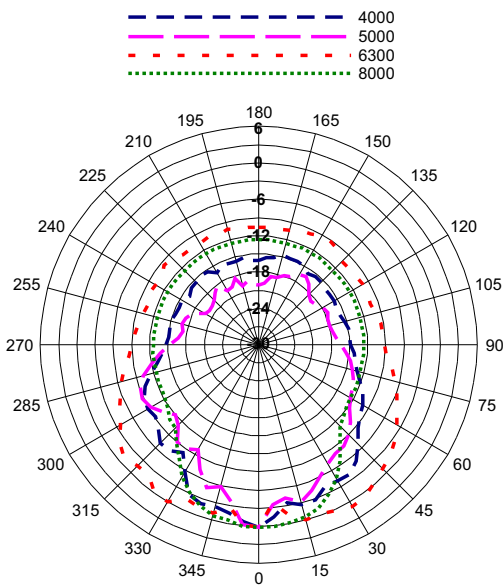

axis normalized vertical polar diagrams

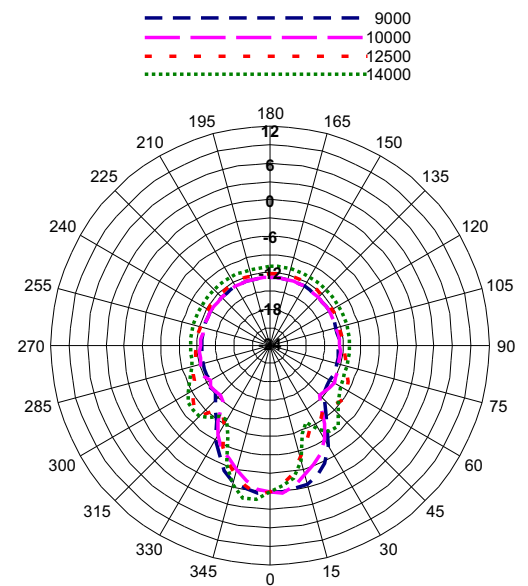

Horizontal coverage

■ -18-6 ■ -6-6 Freq.

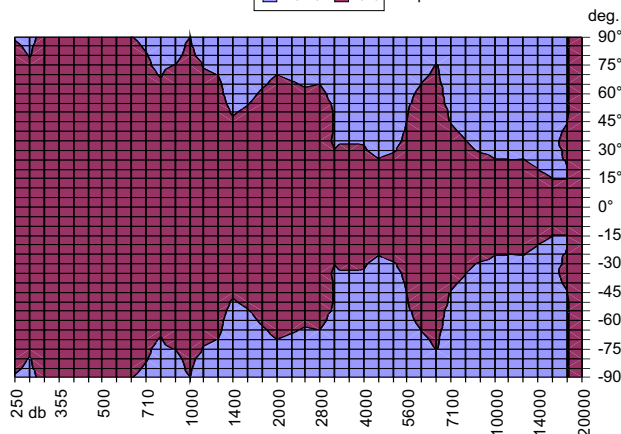



POWER SELECTION

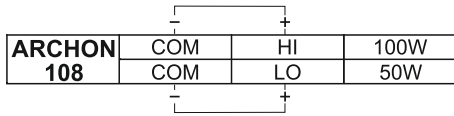

DIMENSIONAL DRAWINGS

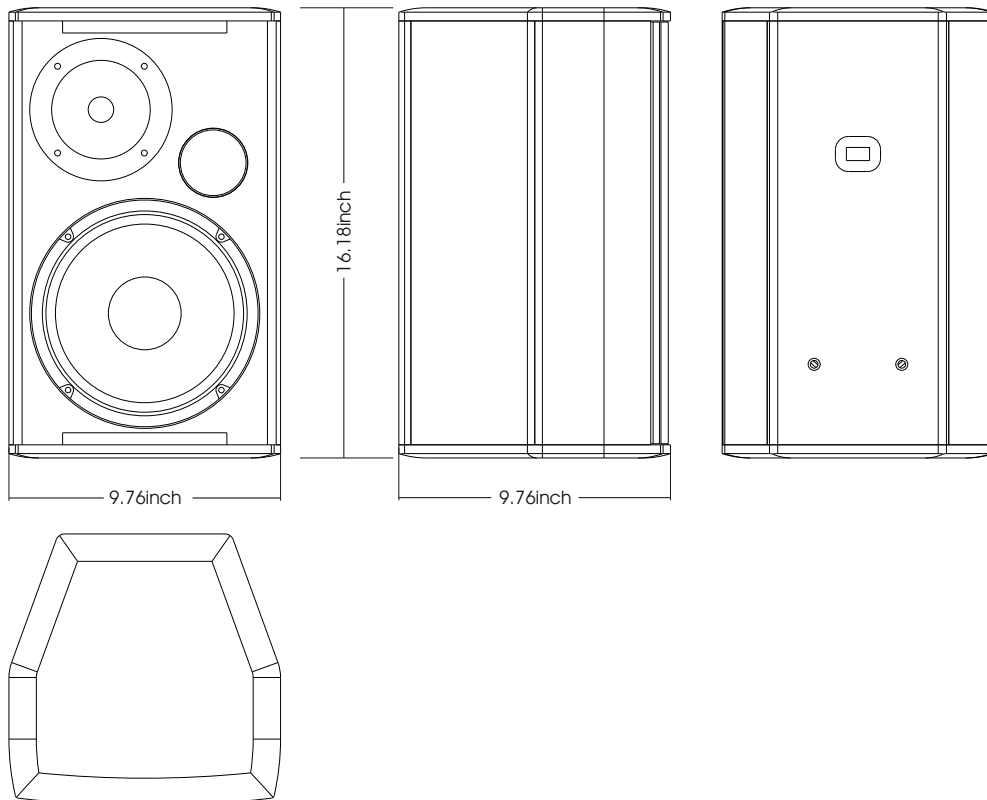

ACCESSORIES

