

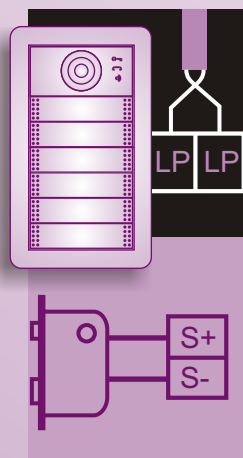
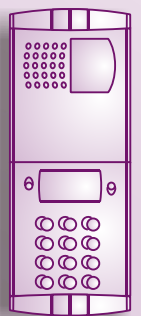
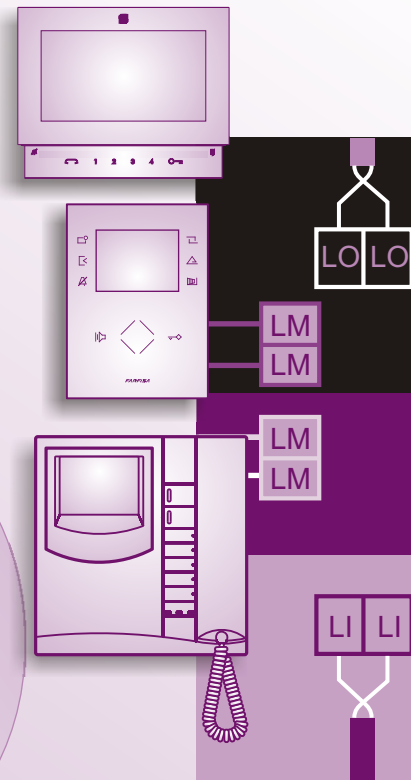
13

# TWO WIRE DIGITAL SYSTEMS

 **FARFISA**

TECHNICAL  
MANUAL  
2018

ZHERO  
MYLOGIC  
EXHITO  
SETTE  
ALBA  
AGORA'  
PROFILO  
MATRIX  
SOLVO



**DUO** system

## PREFACE

This edition contains helpful information on the operation and installation of Farfisa video intercoms systems.

In order to make the systems work properly it is necessary to install only Farfisa equipment, keeping strictly to the items referred to in each diagram.

Read all the notes carefully, (even the small ones) in each installation scheme and the working instructions of the system given in the following pages.

For the sake of clarity, please notice that the sequence of the terminals of each article has not been followed. Only the terminal code (letter and/or number) is valid not the graphic sequence.

The items may have more terminals than the ones in the installation diagrams. The excess terminals must not be used.

## Notice to the installer and user

Check the integrity of the product after removing it from the packing.

Packing materials (such as plastic bags, cardboard, polystyrene foam, etc.) must be kept out of the reach of children.

The manufacturer cannot be held responsible for possible damages caused by improper, erroneous and unreasonable use.

The cable runs of any intercom and video-intercom system must be kept separate from the mains or any other electrical installation as required by **International Safety Standards**.

## WARNINGS

**An all-pole mains switch with a contact separation of at least 3mm in each pole shall be incorporated in the electrical installation of the building.**

**Before connecting the unit, make sure its data correspond to those of the mains.**

**The apparatus shall not be exposed to dripping or splashing.**

**For correct operation make sure that ventilation or heat dissipation openings are not obstructed.**

**Do not open or tamper with power supply or video intercom apparatus when they are ON. There is high voltage inside.**

**Avoid bumping and hitting the video intercom apparatus, it could break of the CRT with consequent projections of fragmented glass.**

**For installation or maintenance refer only to qualified personnel.**



European Mark of conformity to the EEC Directives.



Mark of VDE a German Testing and Certification Institute.

## CEMARK

The CE mark ensures that the product complies with the requirements of the European Community Directives in force; in particular, Electrical Safety 2014/35/EU, Electromagnetic Compatibility 2014/30/EU and Telecommunication Terminals 2014/53/EU Directives.

As set forth by the Directives, the technical documentation and Conformity Declarations are available in the Company's offices for verifications and controls by competent Authorities.



Quality system management certified according to ISO 9001 standard.

## 13 TECHNICAL MANUAL

2018 Edition

	<i>Page</i>
<b>CHAPTER 1</b>	<b>1.1</b>
Main features	1.2
Installation examples	1.4
<b>CHAPTER 2</b>	<b>2.1</b>
<b>Internal stations</b>	
- videointercoms Zhero series	2.2
- videointercoms Zhero S series	2.12
- videointercoms myLogicOne series	2.20
- videointercoms Exhito series	2.29
- intercoms Exhito series	2.44
- videointercoms Sette series	2.55
<b>CHAPTER 3</b>	<b>3.1</b>
<b>Door stations</b>	
- push-button panel Agorà series	3.2
- push-button panel Profilo series	3.11
- push-button panel Matrix series	3.31
<b>CHAPTER 3A</b>	<b>3A.1</b>
<b>Door stations powered from the bus</b>	
- push-button panel Agorà series	3A.2
- push-button panel Solvo series	3A.7
- push-button panel Alba series	3A.17
<b>CHAPTER 4</b>	<b>4.1</b>
<b>Power supplies and service modules</b>	
<b>CHAPTER 5</b>	<b>5.1</b>
<b>Installation instructions</b>	<b>5.2</b>
<b>Installation diagrams</b>	<b>5.16</b>
<b>Product list</b>	<b>5.44</b>

# MAIN FEATURES

Farfisa digital **DUO System**, developed with innovative technology, allows the installation of videointercom systems up to 19800 users and about 900 door stations, drawing **two non-polarized wires only**, including the power supply to the system. The very reduced number of conductors with no coaxial cable allows a fast and simple videointercom and/or intercom installation, reducing mounting costs.

The 2-wire technology allows a videointercom system, with 1 or more entrances, without having to think to the calculation of the conductors on the riser and on the various branches; the wires are always two.

For a good result of the installation it is necessary to follow carefully the indications in this manual and especially it is requested not to exceed the distances recommended by ACI Farfisa.

## Type of installation

The **DUO** digital system allows the realisation of many different types of installation.

- Intercom systems
- Video intercom system
- Mixed intercom/video intercom systems
- Systems with doorkeeper exchanger
- Systems with 1 or more equally important door stations
- Systems with 1 or more main door stations and secondary door stations (with exchanger or distributor of inputs)

## Performances of DUO system

- Maximum distance between external station and farthest videointercom (without amplifier) **200 meters**
- Digital or conventional push-button panels with digital encoder
- **Powered from bus or locally powered door stations**
- Timed conversation (90-second duration with possibility of increasing conversation time by pressing a specific button on the push-button panel)
- Acoustic signal of conversation end
- Private audio-video and lock function (only the called user can see, talk and release lock)
- Coded lock release directly from the digital push-button panel (by means of programmable personal code)
- Busy signal on door stations
- Free tone on internal stations when the installation is available for intercommunicating calls or video auto switching
- Connection up to 10 internal stations in parallel and intercommunicating for each user
- The maximum number of risers, of video intercoms for each line, of main external door stations and of secondary external door stations depends on the schematic to be implemented (see chapter 5).

## Systems with doorkeeper exchanger

(in addition to the functions above)

- Day-Night operating mode: - in **night mode** calls are directly transferred to the users - in **day mode** all calls can be received from the doorkeeper exchanger or by users depending on the door station programming.
- visualisation of the calls on a 64x128 pixel graphic LCD
- possibility of memorising and booking calls at the doorkeeper exchanger during conversations in progress – they will be automatically made when the line is free.
- communication between 2 internal stations.
- possibility of connecting an internal station with a door station.
- possibility of using a wide range of Farfisa intercoms or video intercoms.
- possibility of connecting a monitor at the exchanger with automatic switching ON.
- call transfer – all calls to the doorkeeper exchanger can be transferred to a programmed internal station.

## Choosing the equipment

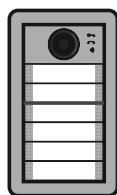
When choosing the articles for the installation, the following aspects must be considered:

- the user's needs
- the number of users
- the installation possibilities
- the possible dislocation of the articles.

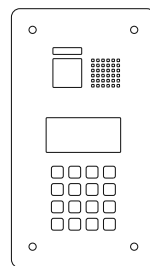
## External door stations (PE)

The following options are available for **door stations**:

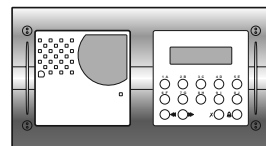
- door stations with or without power supply
- door stations with digital keyboard and selection of display names
- door stations with conventional push-button panels and digital encoder



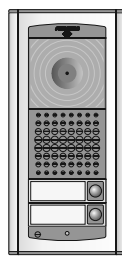
series ALBA



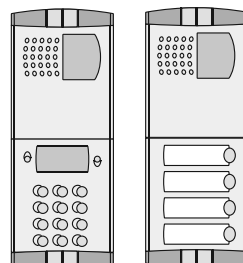
series SOLVO



series Matrix



series Agora



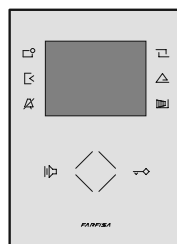
series Profilo

## Internal stations (PI)

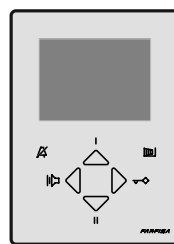
For the **internal stations** in addition to the preferred aesthetic model, the choice must be based on the required performance:

- intercom or videointercom (even OSD or soft touch)
- communication with the handset or in hands-free
- quantity of buttons for intercommunicating calls, enabling actuators, monitoring video door stations, etc ...

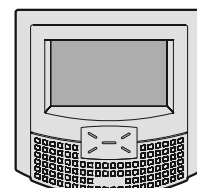
## Videointercoms (VC)



series Zhero



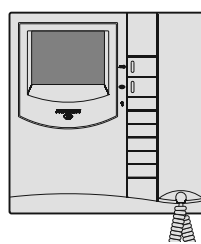
series Zhero S



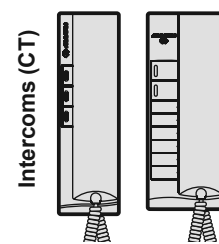
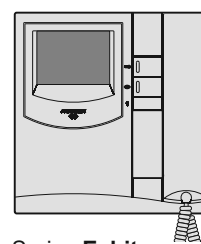
series myLogicOne



series Sette



Series Exhito

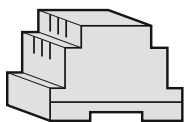


Intercoms (CT)

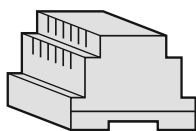
## Power supplies and service modules

### Powersupplies

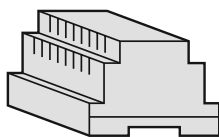
These items provide power to the DUO system and are the only ones in the entire system that must be connected to the mains supply. During the design phase it is necessary to provide for a single mains switch in order to ensure the disconnection of the mains voltage to the entire system for maintenance. Furthermore the electrical line and the DUO line must be routed in different conduits with a distance of at least 10cm between them.



**2220S**  
**PRS210**



**2221S**

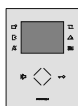


**2221MQ**

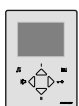
### Video distributors

They distribute the video signal to the various video intercoms and intercoms of the DUO video intercom system. Each derived output connects a video intercom (or intercom); if there are more than one video intercom/intercom in parallel (max.3) in the apartment they can be connected to each other in serial (in-out) terminating the impedance only on the line of the last apparatus. There are **2 types of video distributors** identifiable by the final letter of the part number: **programmable (A)** type and **active (Q)** type.. The intercoms can be connected to all distributors of mixed intercom/video intercom systems while intercom-only systems can be connected directly to the riser.

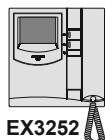
**DV2422A**  
**DV2421Q**  
**DV2424Q**



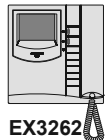
**ZH1262**



**ZH1252W**



**EX3252**



**EX3262**



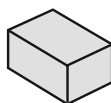
**ML2002**



**SE4252**

### Line distributor

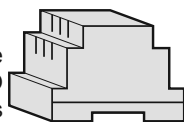
Allows the power, data and audio to be sent on the two wires of the DUO system.



**DV2420**

### Line separator

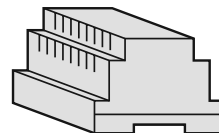
It is used for separating and isolating a riser or the equipment of one or more apartments from the DUO condominium lines allowing the simultaneous operation of several risers or intercommunicating services and home automation in individual apartments. The 2231Q separator also allows a secondary door station to be connected. The 2231Q separator is necessary for DUO extended range with up to more than 20000 devices.



**2231Q**

### Riser distributor

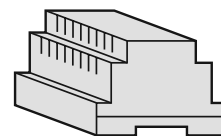
Allows the distribution of the video signals from 4 door stations on 4 risers according to the user addresses programmed in the output line numeric intervals. For a greater number of inputs and/or outputs use additional distributors. Any of the outputs may be used to connect a doorkeeper exchanger.



**DM2444**

### Modulator

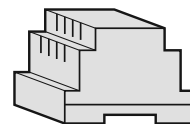
Allows the insertion in any point of the bus of 1 or 2 surveillance cameras. From the video intercoms, the images of the two cameras can be displayed sequentially or individually using appropriately programmed buttons.



**VM2521**

### Actuator

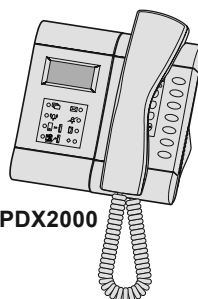
Connected anywhere on the DUO line it allows the activation of relays or services without having to add additional wires to the condominium line. It can be activated from the internal stations by means of dedicated buttons or through sensors or buttons connected to the IN input. The output relay can operate as monostable, bistable or with a programmable time. It occupies 1 DIN bar module.



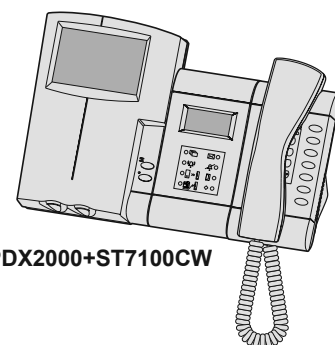
**2281Q**

### Doorkeeper exchanger

Desk doorkeeper exchanger (with possible application to the wall) with display, alphanumeric keypad and 7 buttons for the main functions. Commutations: day, night and direct call. With directory, booking of calls, communications between internal users or internal users and door stations with possibility of inclusion. You can view images of the video door stations applying a ST7100CW monitor or a monitor CCTV to the doorkeeper exchanger.



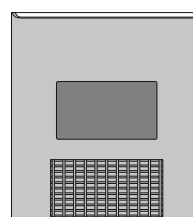
**PDX2000**



**PDX2000+ST7100CW**

### Programmer

Device for programming the DUO system. It can be connected to any point of the bus relative to the portion of the system that is to be programmed. It is powered directly from the DUO bus.

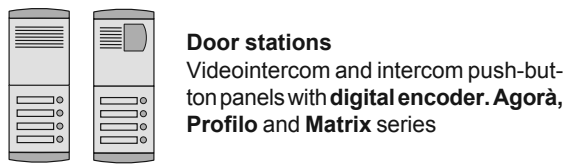
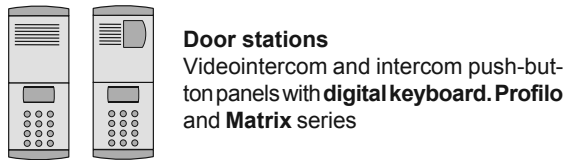
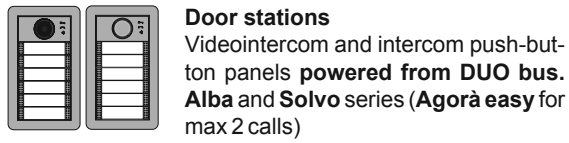


**PGR2990**

# INSTALLATION EXAMPLES

## Legend

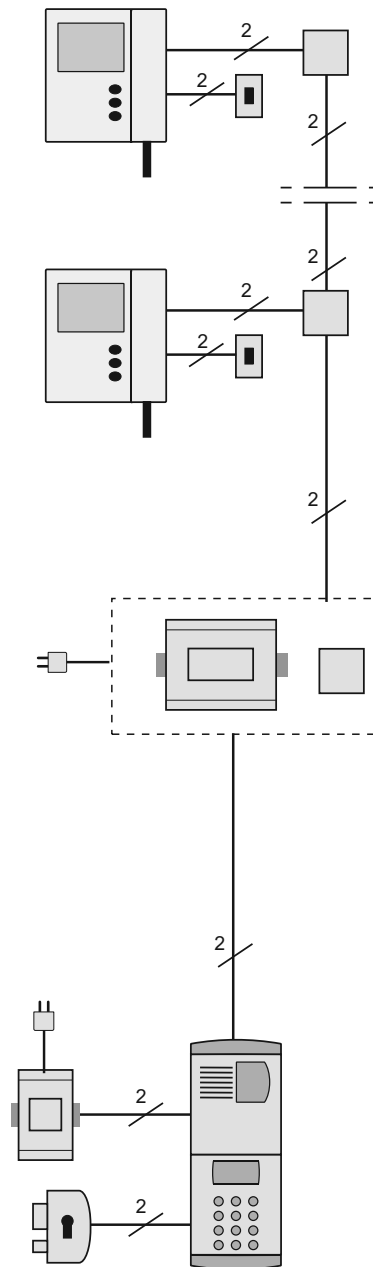
Graphic signs of installation examples



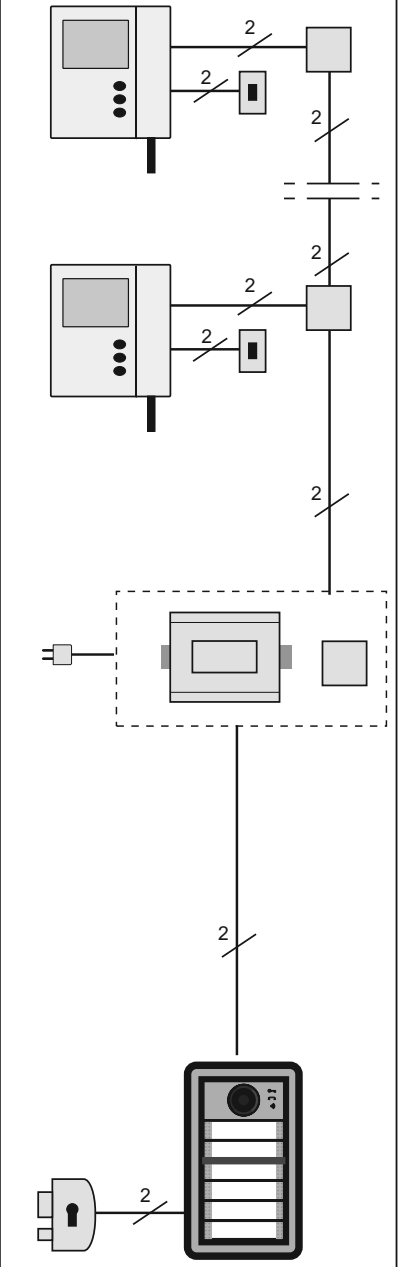
## Videointercom systems

### Multi-way installation with 1 audio-video door station and 1 riser

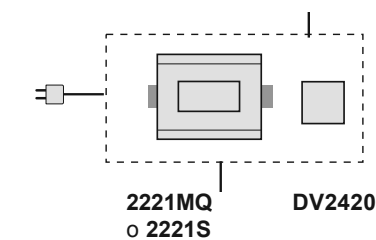
#### a) With locally powered push panel



#### b) With powered from DUO bus push panel (only two wires)

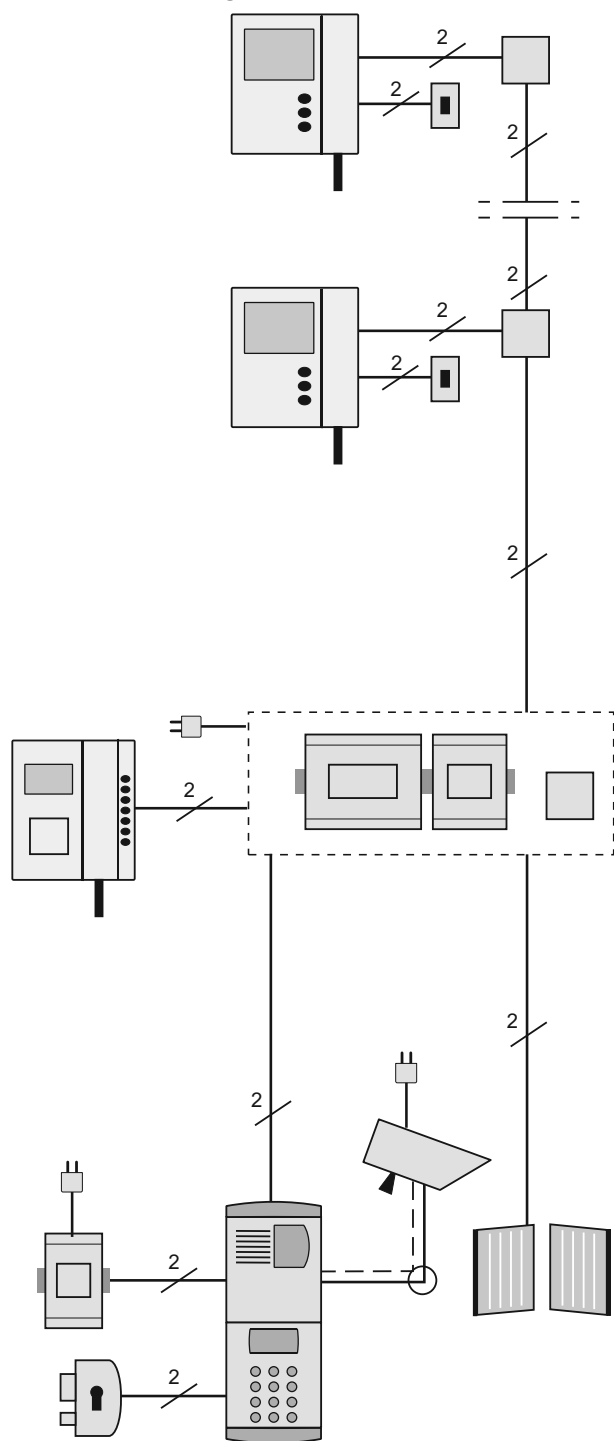


#### Articles in the dashed box

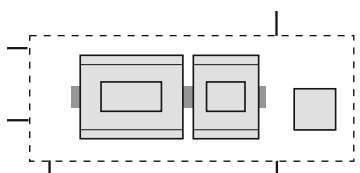


# INSTALLATION EXAMPLES

Multi-way installation with 1 audio-video locally powered door station, additional TVCC camera, automatic gate and doorkeeper exchanger

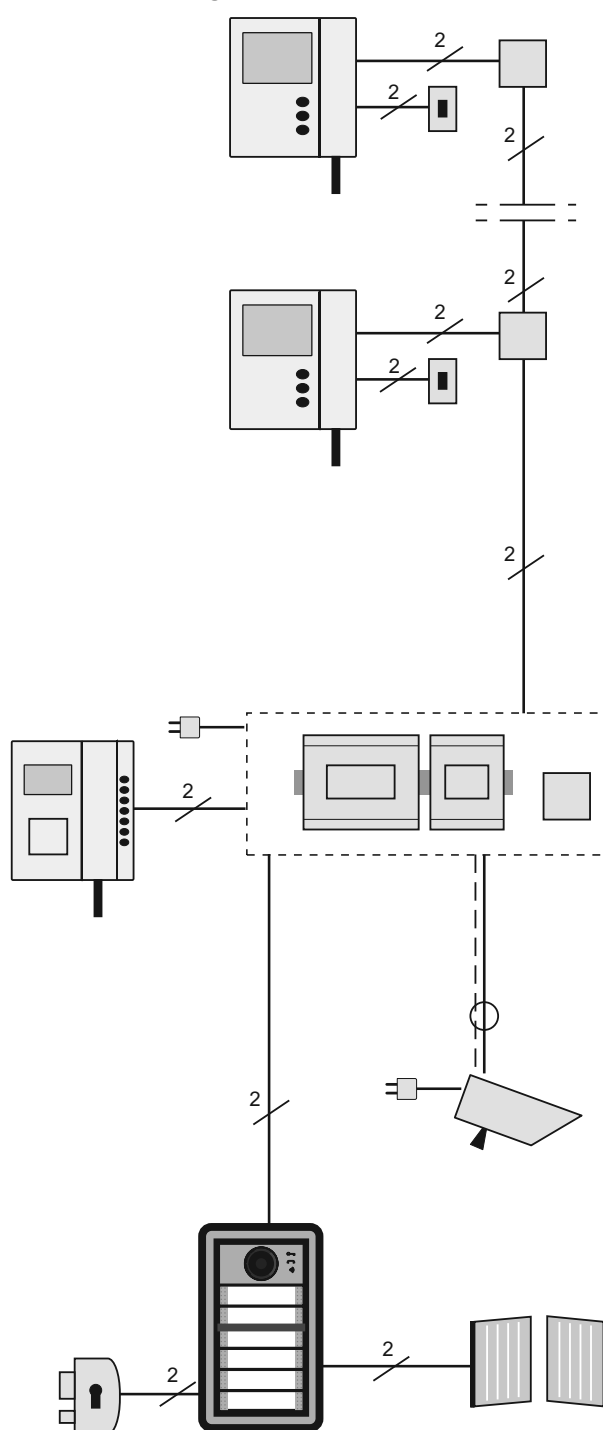


Articles in the dashed box

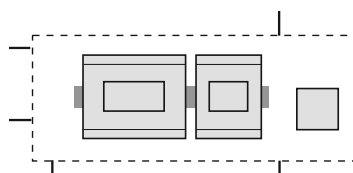


2221MQ 2281Q DV2420  
o 2221S

Multi-way installation with 1 audio-video powered from DUO bus door station, additional TVCC camera, automatic gate and doorkeeper exchanger



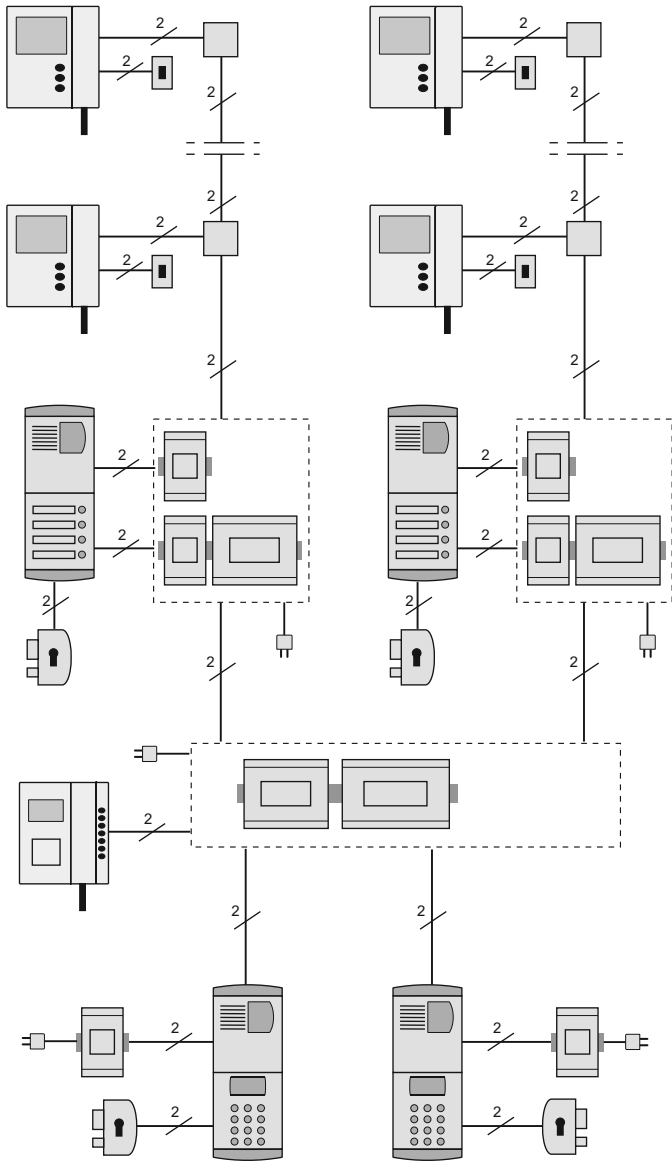
Articles in the dashed box



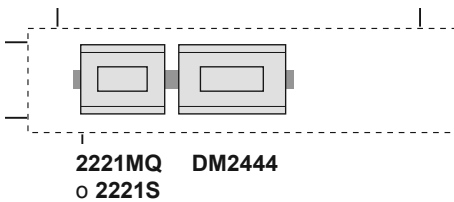
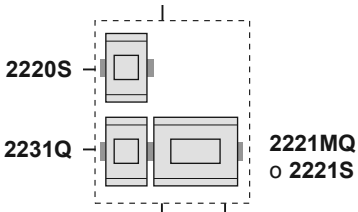
2221MQ VM2521 DV2420  
o 2221S

# INSTALLATION EXAMPLES

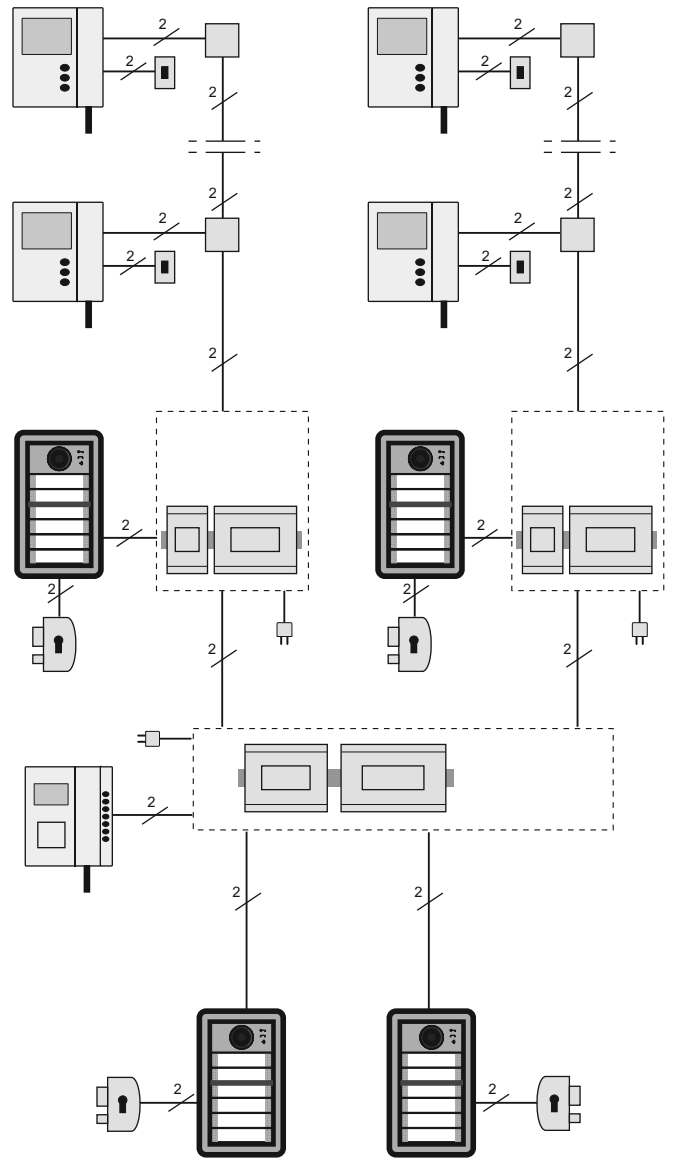
Multi-way installation with 2 audio-video door stations, 2 or more secondary audio-video door stations and doorkeeper exchanger. Independent operation between the risers.



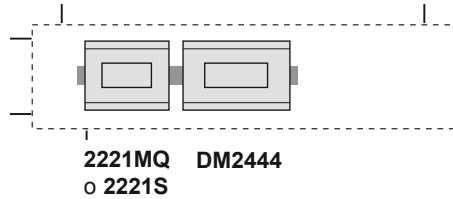
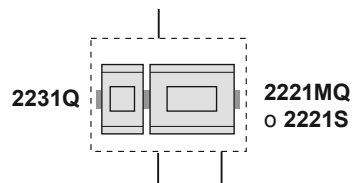
Articles in the dashed box



Multi-way installation with 2 audio-video door stations, 2 or more secondary audio-video door stations and doorkeeper exchanger. Independent operation between the risers. All door stations are powered from DUO bus

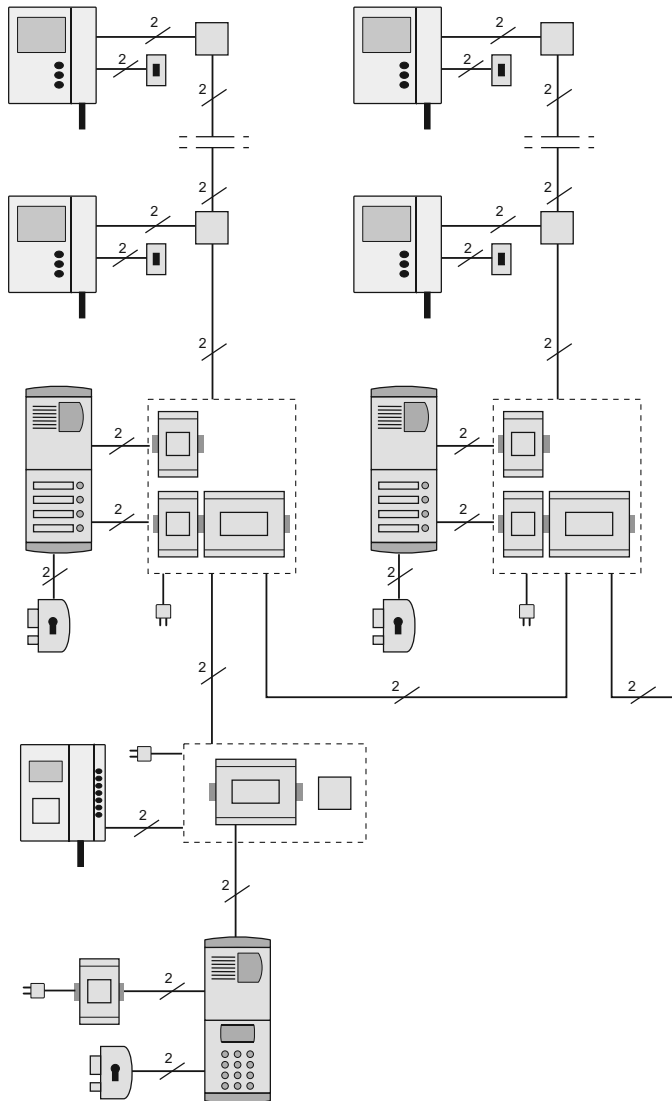


Articles in the dashed box

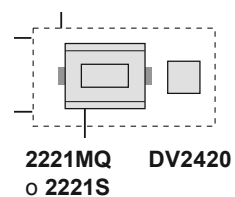
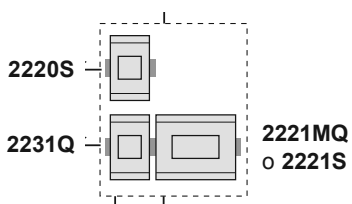




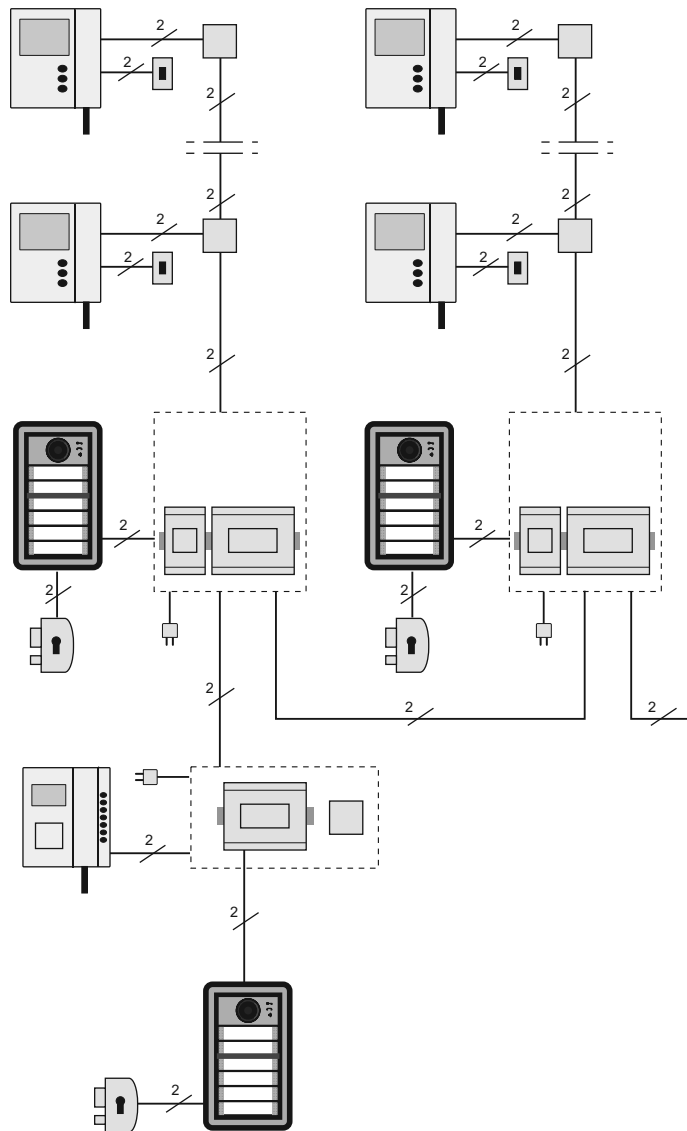
**Multi-way installation with main audio-video door station and division on multiple risers with secondary audio-video door station.** Independent operation between the risers and the possible insertion of a doorkeeper exchanger. DUO line in-out connection to the risers.



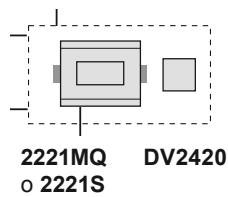
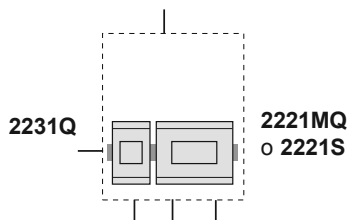
Articles in the dashed box



**Multi-way installation with main audio-video door station and division on multiple risers with secondary audio-video door station.** Independent operation between the risers and the possible insertion of a doorkeeper exchanger. DUO line in-out connection to the risers. **All door stations are powered from DUO bus.**

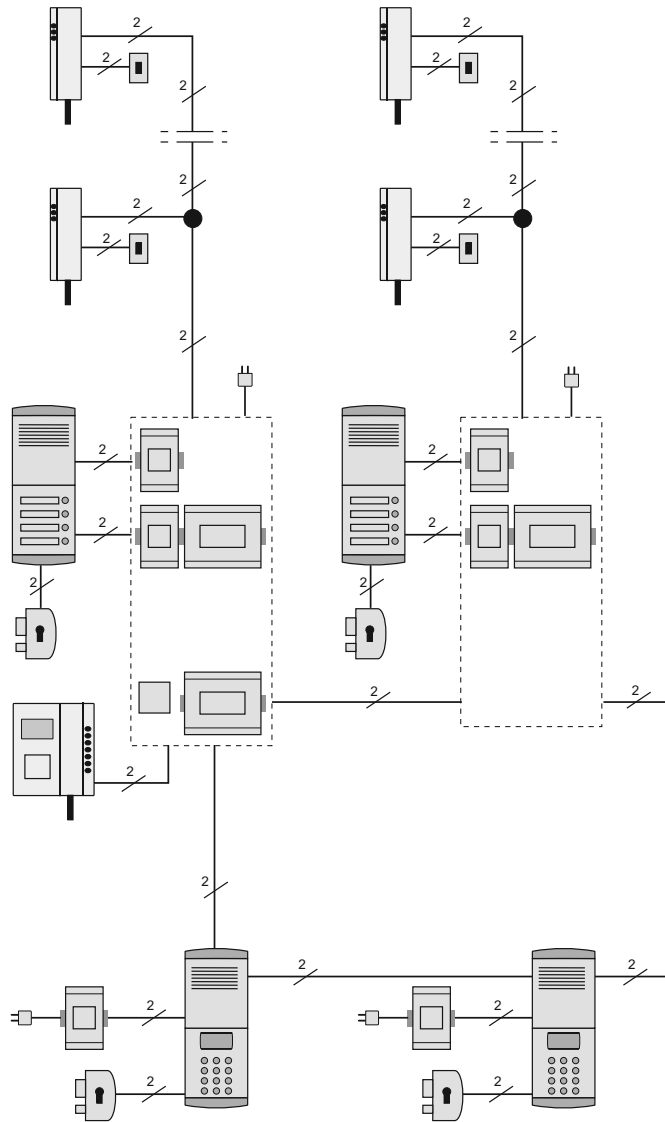


Articles in the dashed box

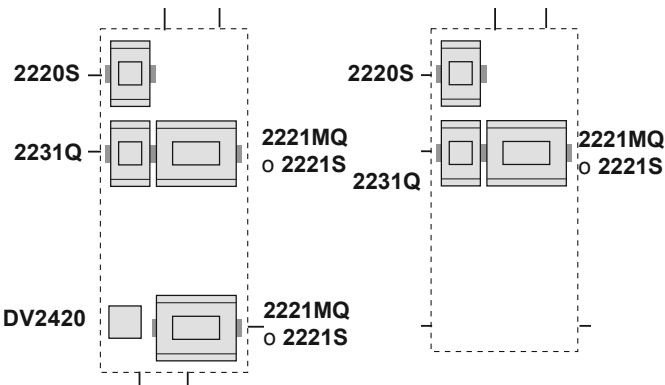


## Intercom systems

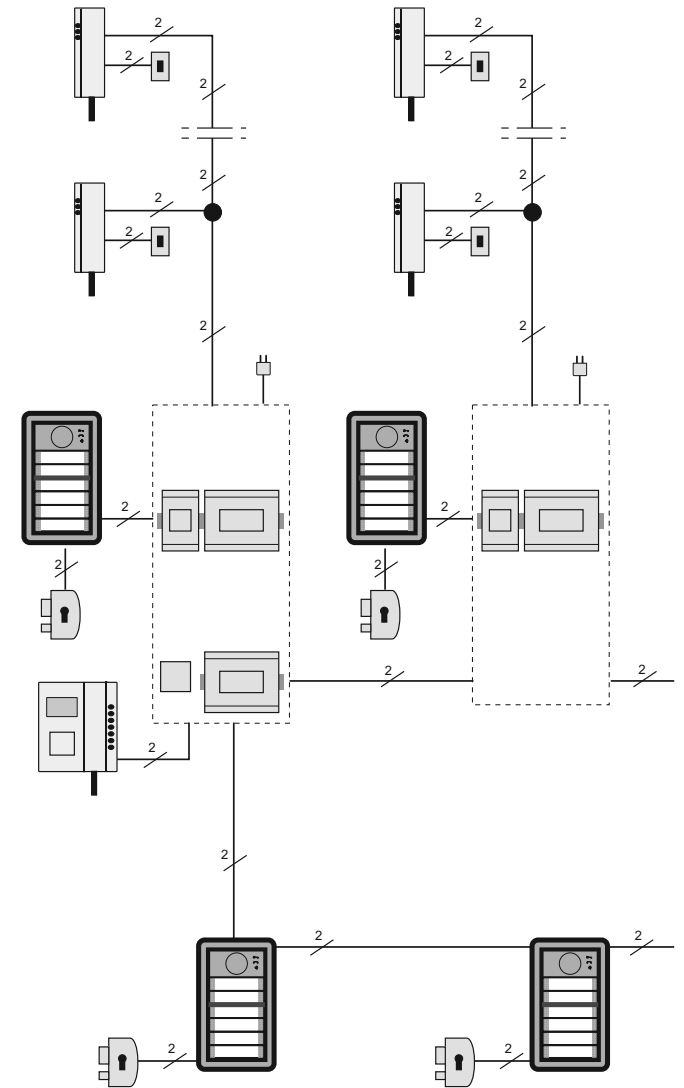
Multi-way installation with 2 main audio door stations, 2 secondary audio door stations and doorkeeper exchanger. Independent operation between the risers.



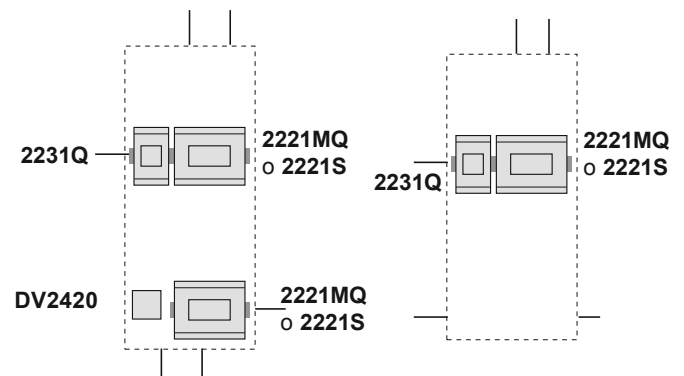
Articles in the dashed box



Multi-way installation with 2 main audio door stations, 2 secondary audio door stations and doorkeeper exchanger. Independent operation between the risers. All door stations are powered from DUO bus.



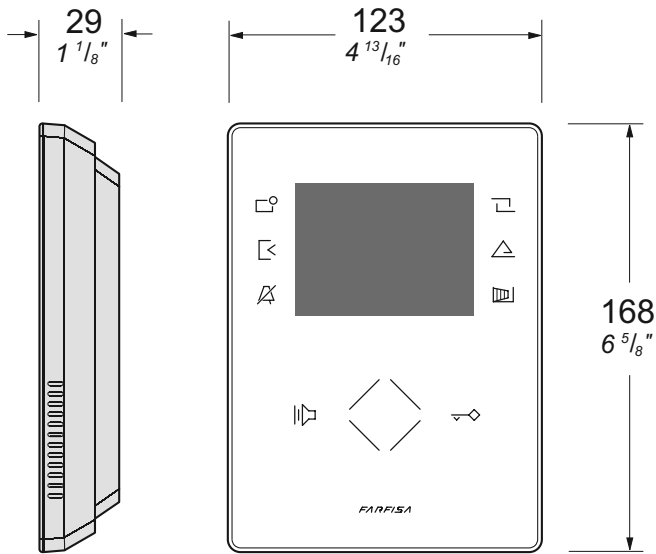
Articles in the dashed box



# INTERNAL STATIONS

	<i>Page</i>
ZHERO Series	2.2
ZHERO S Series	2.12
myLogicOne Series	2.20
EXHITO Series	2.29
- Videointercom EX3252	2.29
- Videointercom EX3262	2.37
- Intercom EX352	2.44
- Intercom EX362	2.50
SETTE Series	2.55

VIDEOINTERCOMS



**ZH1262B.** Colour videointercom with 3.5" and OSD technology that enables displaying, together with the image, indications, information and commands for correct programming, setup and operation of DUO videointercom system.

To program and enable video intercom functions use the 8 "soft touch" keys (of which 6 are programmable) and the wheel sensor.

Front black with audio-video privacy, intercommunicating service, control switch-ON of multiple door stations, differentiated programmable ring tones, audio, contrast, and brightness adjustment.

It can be installed on the wall by using the annexed wall-bracket or desktop adapter art. **TA1260**.

**ZH1262W.** Videointercom with same features as above, in white colour front.

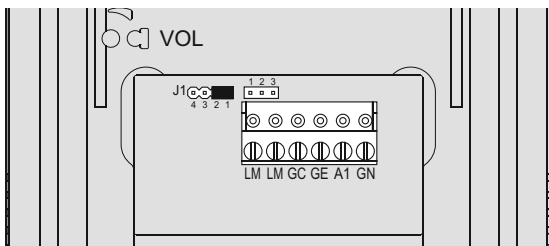
**Technical characteristics**

Power supply directly from the line

Stand-by current:	8mA
Operating current:	280mA
Screen:	3.5" LCD
Television standard:	PAL
Horizontal frequency:	15625Hz
Vertical frequency:	50Hz
Band width:	>5MHz
Operating temperature:	0° ÷ +40°C
Maximum admissible humidity:	90%RH

**Terminal boards**

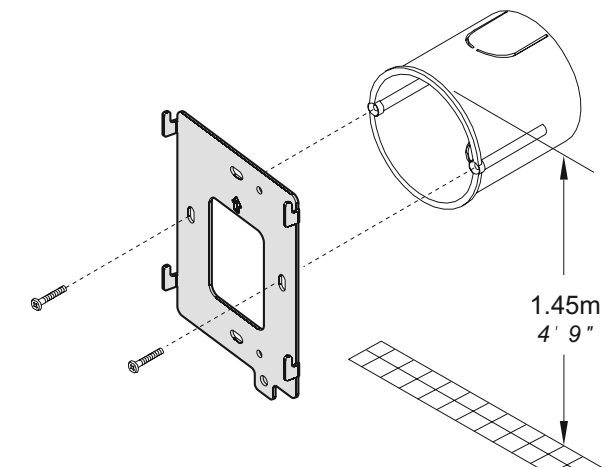
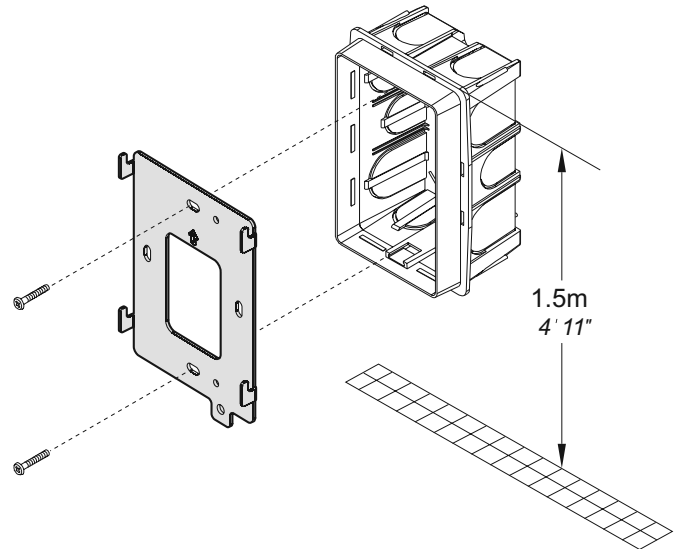
- LM/LM** Line inputs
- GC** Positive output for additional functions
- GE** Negative output for additional functions
- A1** Floor call positive input
- GN** Floor call negative input



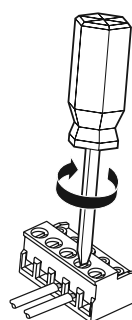
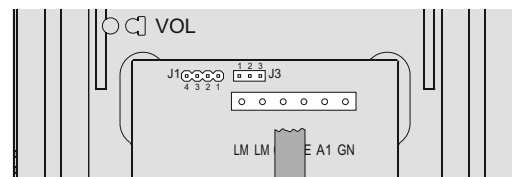
INSTALLATION

Flush mounted version

- 1 - Mount on the wall a built-in box of 83mm or 60mm at approximately 1.5 meters above the ground.
- 2 - Screw the bracket to the built-in box.



- 3 - Unplug the terminal block from the videointercom.

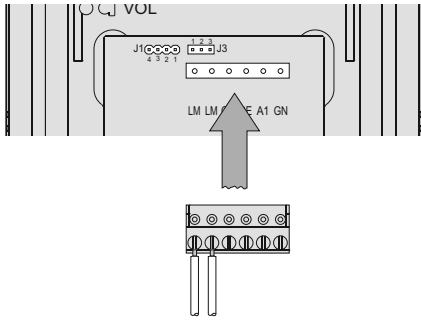


- 4 - Make the connections as required by the electric diagram.

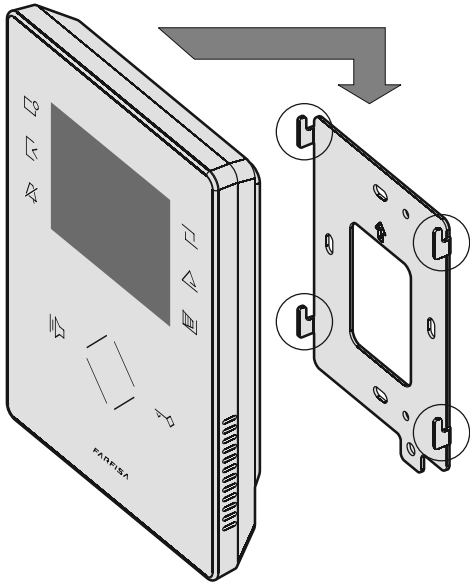
**Warning:** Do not use sharp objects to remove the terminal block



5 - Plug-in back the terminal block on the videointercom.



6 - Fix the video intercom to the wall bracket.



7 - Dismounting the video intercom.

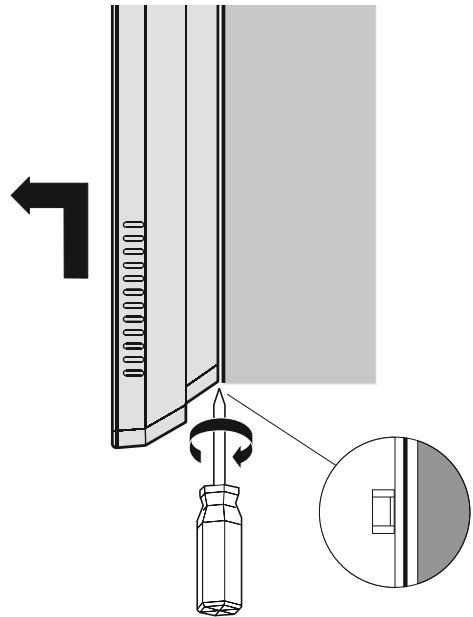
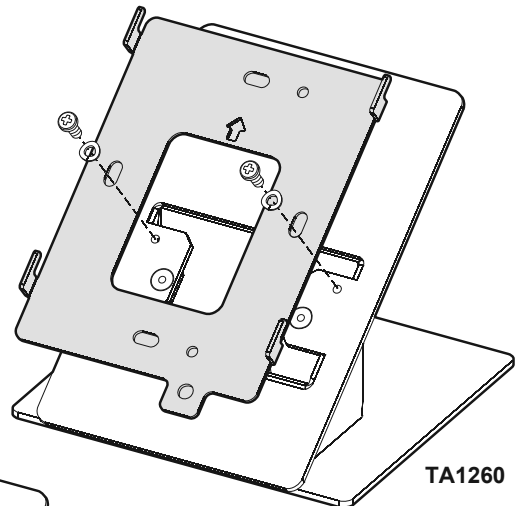


Table version

**TA1260.** Table adapter for ZH1262 videointercom. Complete with junction box and 2.4m connection cable with 20 wires.

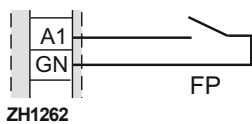


## Additional functions

### Floorcall

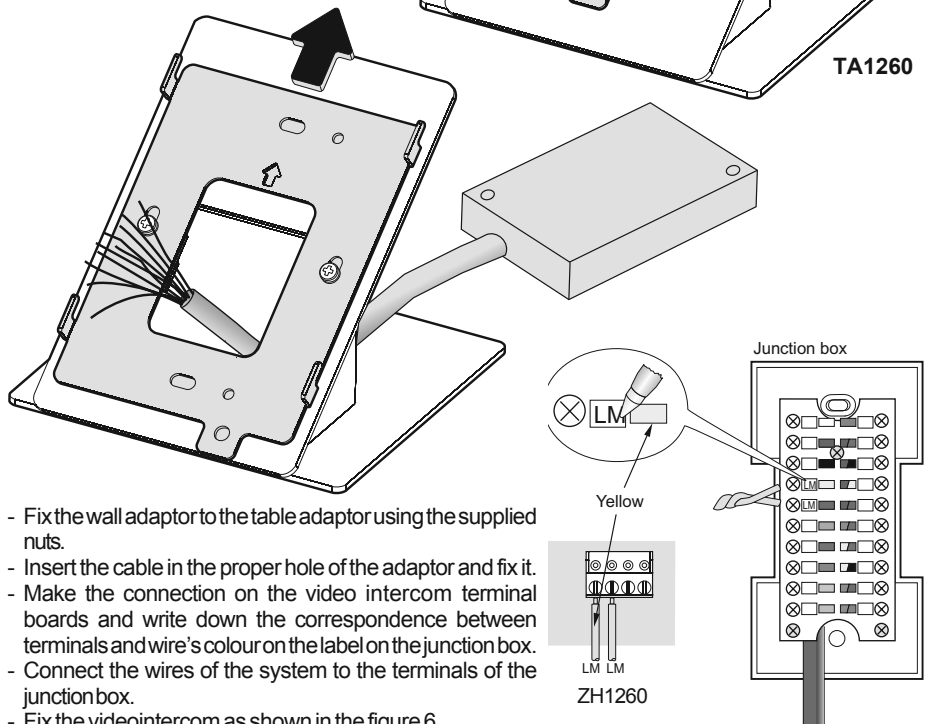
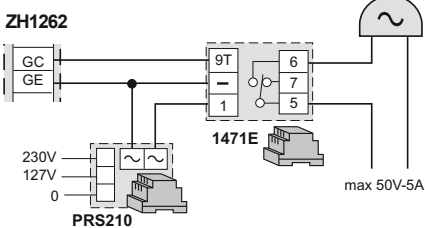
To receive a floor call you must connect a button (FP) between terminals **A1** and **GN** of the videointercom.

When the button FP is pressed, the videointercom speaker will receive a call different from calls from the external stations. The call is received also if the videointercom is in conversation.



### Callrepeater

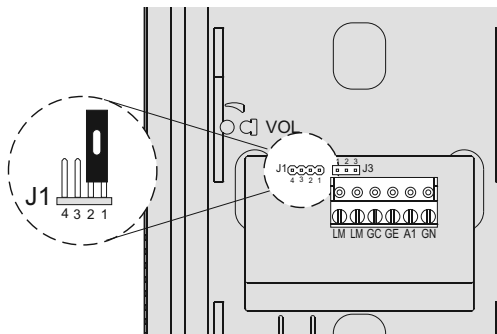
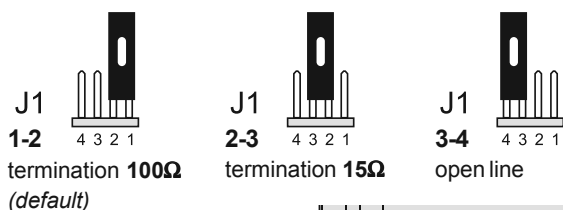
To relaunch the call of the videointercom in other parts of the apartment add a relay 1471E and a transformer PRS210.



- Fix the wall adaptor to the table adaptor using the supplied nuts.
- Insert the cable in the proper hole of the adaptor and fix it.
- Make the connection on the video intercom terminal boards and write down the correspondence between terminals and wire's colour on the label on the junction box.
- Connect the wires of the system to the terminals of the junction box.
- Fix the videointercom as shown in the figure 6.

## Selecting the closing impedance

The jumper **J1** provided on the back of the videointercom can be used to adjust the video signal coming from the riser and thus improve the quality of the image displayed.

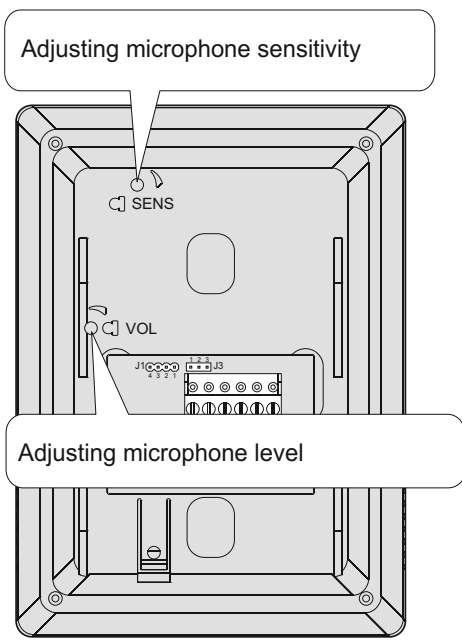


## Audio adjustments

Audio level and ringtone volume can be adjusted during conversation by means of special controls (see chapter 1 on page 2.11). Normal audio levels are set in the factory; settings on the back of the device must be changed only if really necessary.

### Setting the sound levels.

- If audio is excessively intermittent during the conversation or the speaker tends to distort it during the call, it is recommended to slightly change the microphone sensitivity using the **SENS** trimmer on the back of the video-intercom.
- In case of problems in getting the audio in one of the two directions, slightly increase the level of the disturbed channel and decrease the level of the other channel using the **VOL** trimmer for the microphone volume.



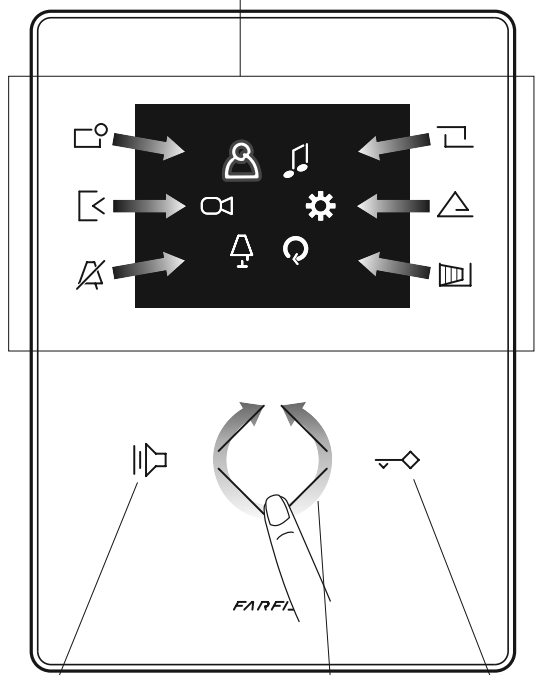
## MAIN FUNCTIONS OF THE KEYS

The 6 keys on screen side and the wheel sensor allow the user to access the operating modes, setup and programming pages of the videointercom; these keys modify their function according to the indications shown on the screen.

The “” and “” keys are dedicated to videointercom functions.

**Warning.** A dissuasion tone and the Farfisa logo flashing when any of the keys is pressed, warn the user that the function is not available because the service is not active or **the videointercom line is being used by other users.**

Every key , , , , and enables the function shown on the screen and varies according to the operating state of the videointercom.



**It enables:**

- monitor of external video door stations (or the last active station if there are several entrances);
- voice communication after having received a call or monitoring function;
- closing the communication with the external doorstation. The conversation also ends when the conversation time of the monitor or the system expires.

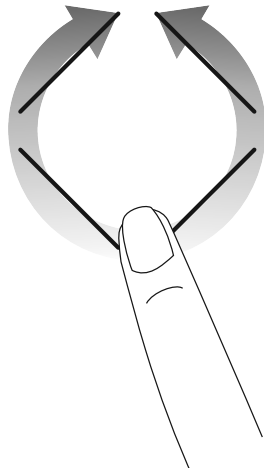
It enables operating the electric door lock of the entrance in communication or the last entrance which has made a call.

Rotary for selecting or searching and subsequent touch to confirm.

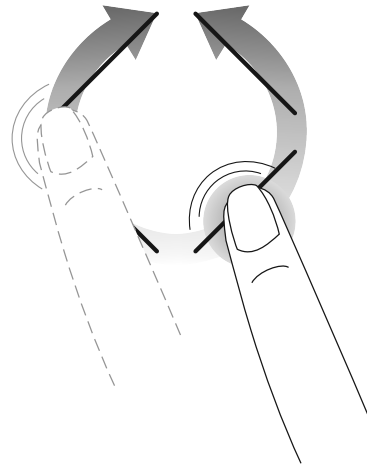
The Zhero videointercom uses a freeRTOS operating system (<http://www.freertos.org>).  
 Sounds and ringtones by: <http://www.freesfx.co.uk>  
<http://www.audionatix.com>  
 For further information visit: [www.farfisa.com](http://www.farfisa.com)  
 mail: [info@farfisa.com](mailto:info@farfisa.com)

**How to use the middle wheel**

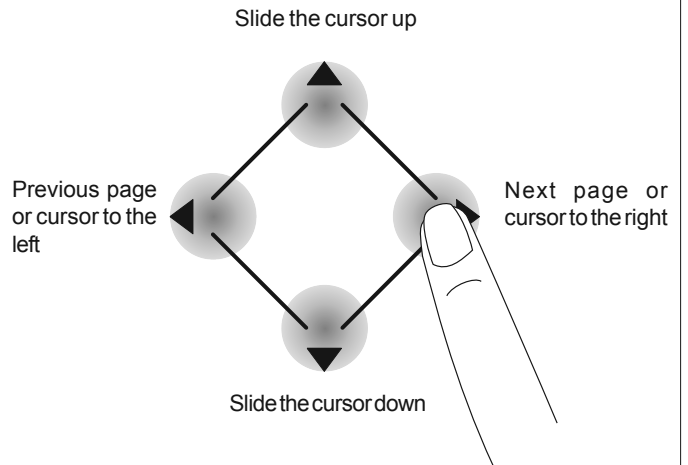
Rotary movement for selecting or searching



Rotary movement for selecting or searching and subsequent touch to confirm.



**How to move the cursor or change the page**



**Access the main menu**

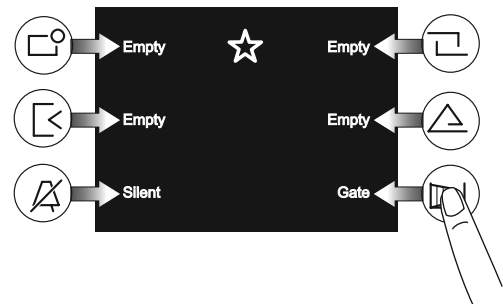
With the monitor in stand-by and no other videointercom turned ON in the system, access the menu by touching any active point of the wheel sensor. From the menu the user can access all programming, setup, adjustments and activation pages of the videointercom.



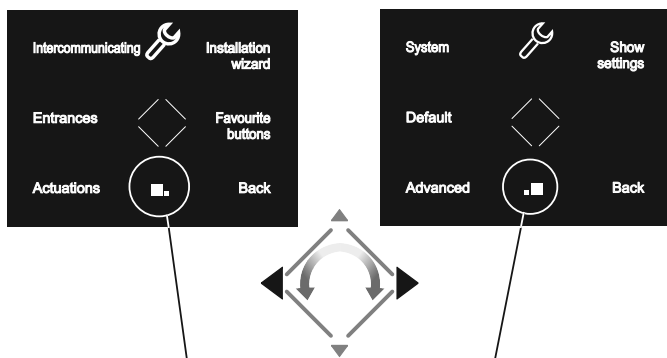
**Access the "Favourite buttons" menu**

With the monitor in stand-by and no other videointercom turned ON in the system, to access the favourite buttons menu and the specific functions associated to every key during programming ("favourite buttons" on page 2.9).

The next image shows the display with factory settings



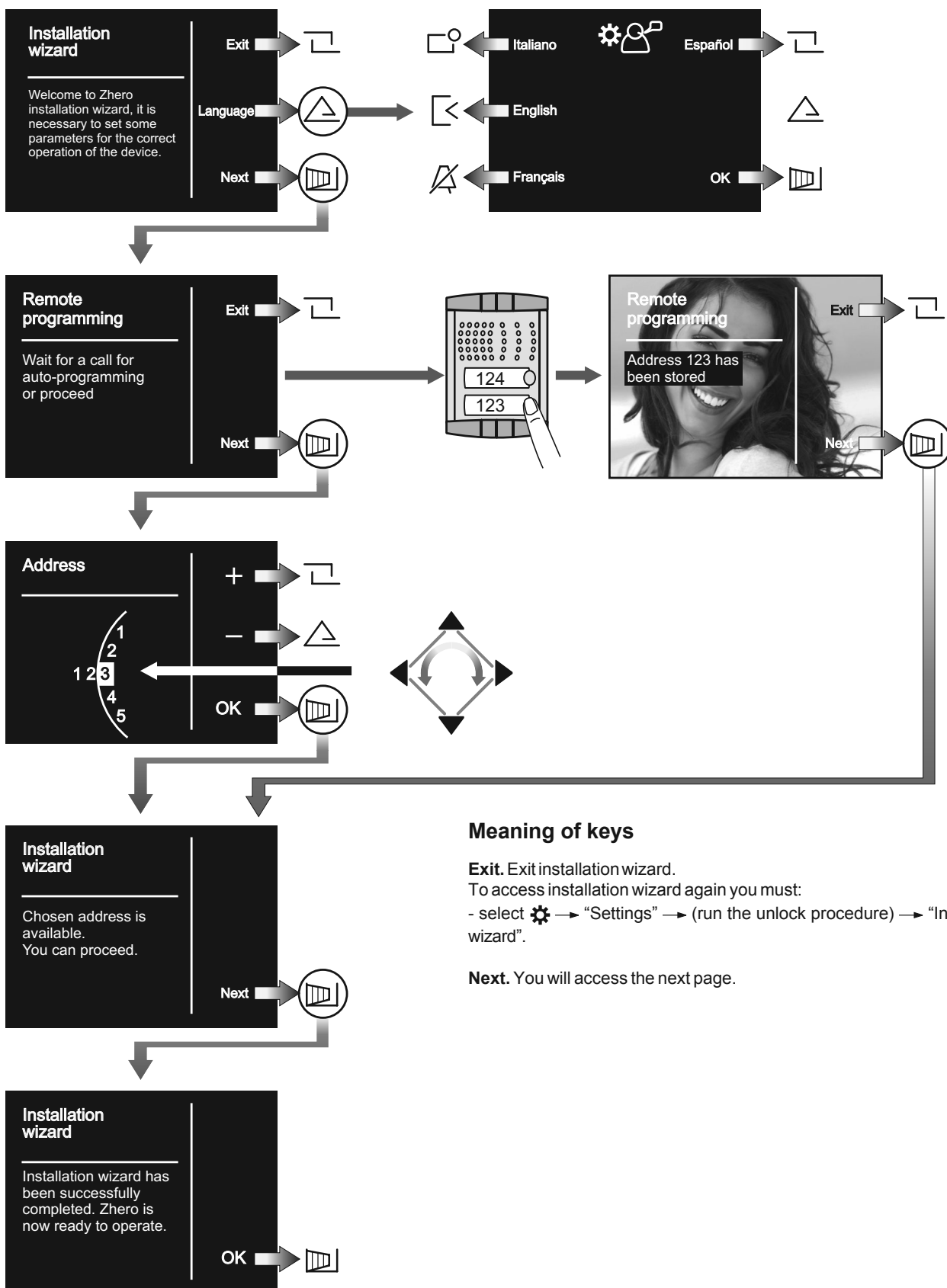
**How to display next/previous functions of a page**



If on middle bottom screen are displayed 2 or more boxes it means that the functions are present in several pages. Use the keys ◀▶ or rotate the wheel sensor to move from one page to another.

## Installation wizard

To enable easy device programming, at first power-ON (or subsequently if selected in "Set-up" menu) will start an installation wizard. This procedure enables fast and easy setup of essential parameters for videointercom operation such as device address and room number, the latter required only if there are several devices installed in the same apartment. For further details refer to the following pictures. Should it be required to set other parameters the user can access the "Settings" menu - from page 2.7 to page 2.10.



### Meaning of keys

**Exit.** Exit installation wizard.

To access installation wizard again you must:

- select → "Settings" → (run the unlock procedure) → "Installation wizard".


**Next.** You will access the next page.



## PROGRAMMING

To ensure correct operation of the videointercom, the latter must be programmed by the installer; incorrect programming may compromise the operation of the whole system. The main parameters to be set are the following

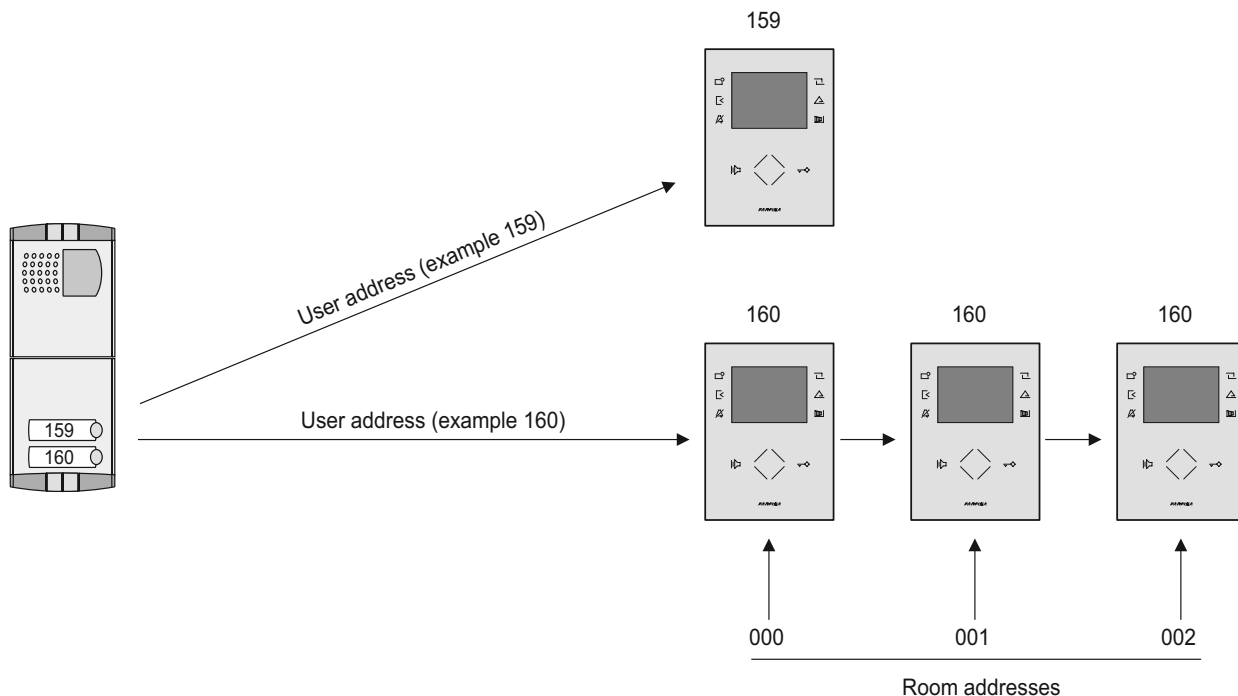
- **User address (mandatory)**; this address identifies the videointercom device within the installation. Enter a number from 001 to 200 taking into consideration the following:
  - the number of the apartment should not be equal to that of another apartment; if there are several internal stations connected in parallel in the same apartment, they should have the same user address but different room number (see the next section);
  - it should match the address stored in the external push-button panel and the door keeper exchanger, if any;
  - it should be stored in the calling key and the contacts of another device, if intercommunication between the two users is required.
- **Room number (mandatory in case of multiple devices in the same apartment)**; identification address of a device inside the same apartment (addresses from 000 to 009). The room number establishes a hierarchy in the internal devices since the device with room address **0 (zero)** will be the main device and all the other devices will be the secondary ones. The different room number enables making/receiving calls between devices installed within the same apartment selectively. The external calls or calls from another apartment will make all devices ring, the first device that answers the call will activate the conversation and switch OFF the ringer of the other devices. When you receive a call from an external door station equipped with camera, all the devices will ring, but only the main device (room address 0 - zero) will display the camera image. The entrance can be displayed from any of the other videointercom installed in the same

apartment by pressing the key “”; this key disables all buzzers, turns ON the relative videointercom, while turning OFF the main videointercom screen.

- **Intercommunication devices; names and addresses of other devices** that you intend to communicate with such as:
  - users of other apartments; it allows to call them selectively (addresses from 001 to 200);
  - videointercoms in the same apartment; it allows to intercommunicate with the equipment of other rooms in the same apartment (room number from 000 to 009);
  - door keeper exchangers (addresses from 201 to 210).
- **Entrances; names and addresses of external door stations** (not necessary in the case of a single door station) to enable the videointercom to monitor these entrances separately and operate the lock, if needed (addresses from 231 to 250).
- **Actuations; names and addresses of actuators** for additional services (additional locks, stair lights, etc.) that can be activated directly from the videointercom (addresses from 211 to 220).
- **Favourite buttons**; when the monitor is in stand-by, the 6 side keys can be used to directly activate additional services that are used more frequently (automatic gate, stair lights, intercommunicating calls, calls to door keeper, etc.).




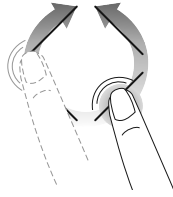
**Warning:** the addresses stored in the videointercom must be the same of those programmed in the devices to enable.




## Programming


**Installation wizard** enables setting user addresses only; all the other parameters can be set proceeding as follows:

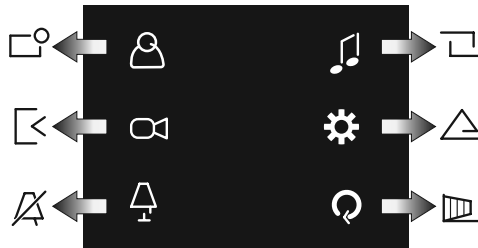
- operate the wheel to access the main menu;
- select  → "Settings" → (run the unlock procedure) → access sub-menus to set the required parameters following the indications below.





 **Intercommunicating** - List of intercommunication devices stored in the videointercom.


 **Entrances** - List of entrances present in the system.


 **Actuators** - List of actuators present in the system.



 **Ringtones** - Pre-listening and assignment of ringing melodies to individual intercommunicating calls, calls from door stations and floor calls.

 **Maintenance** - In this menu the user can modify parameters that are used more frequently; to modify other parameters access the "Settings" menu.

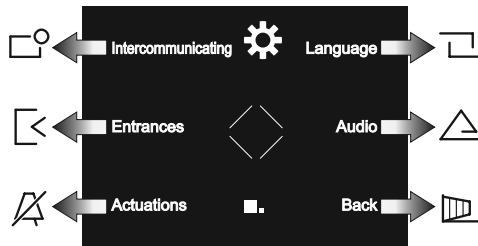
 **Exit.** Exit the main menu; the monitor shuts down.

 **Maintenance** - In this menu the user can modify parameters that are used more frequently and that do not compromise system operation; to modify other parameters access the "Settings" menu.

**Intercommunicating** - Possibility to change the name, the melody of ringtone and the sorting of intercommunicating calls in the list.

**Entrances** - Possibility to change the name, the melody of ringtone and the sorting of calls from external door stations in entrances list.

**Actuations** - Possibility to change the name and the sorting in actuations list.



**Language** - List and selection of languages available.

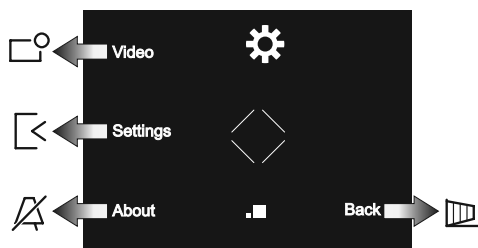
**Audio** - Change sound and volume of keys and ringtone volume and duration.

**Back** - Return to previous page.


**Video** - It enables adjusting brightness, colour and contrast of video image.

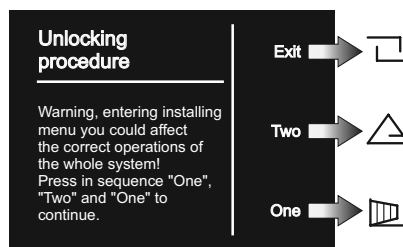
**Settings** - This menu is reserved exclusively to qualified staff; therefore, it is protected by password.

**About** - Software version of the device.



**Back** - Return to previous page.

 **Settings** - This menu is reserved exclusively to qualified staff; therefore, it is protected by password.



(following to next page)



## INTERNAL STATIONS

**Intercommunicating.** Enter the **addresses** and the **names of the devices** with which the videointercom should communicate. The names can be modified at a later time by the user by accessing the "Settings" menu.

**Entrances.** Enter the **addresses** and the **names of the entrances** to which the videointercom should connect. The names can be modified at a later time by the user by accessing the "Settings" menu.

**Actuations.** Enter the **addresses** and the **names of the devices that can be activated** by videointercom. The names can be modified at a later time by the user by accessing the "Settings" menu.

**System.** Here the user can set the following addresses: user, room, supplementary and forwarding A1.

**Default.** It enables resetting the factory settings of the device; if there are any intercommunicating devices, external door stations and actuators programmed, such entries will not be deleted.

**Advanced Settings.** Procedures and information protected by password that can only be accessed by Aci Farfisa technical service.

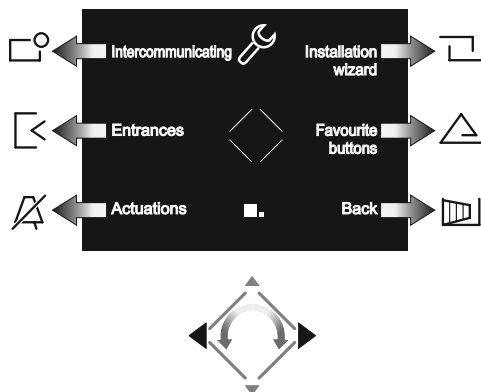


**System** - Here the user can set the specific parameters of the system which allow the proper functioning videointercom system.

**Address.** Enter the user address corresponding to that memorized in the external stations and the door keeper exchanger. Numbers from 001 to 200.

**Room.** Address that uniquely identifies all the devices installed in the same apartment (with the same user address). Numbers from 000 (main device) to 009 (secondary devices).

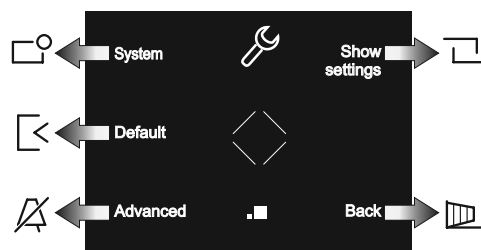
**Supplementary addresses.** Addresses of other users to which the device must answer. Beside the additional user address, it is required to set the correctly room number.



**Installation wizard.** See page 2.6.

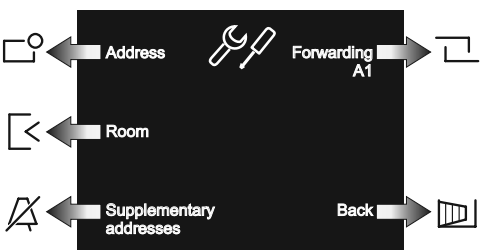
**Favourite buttons.** Select the key to be programmed and then the function to assign.

**Back** - Return to previous page.



**Show settings** - List of all actual settings.

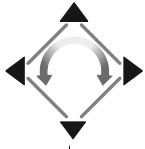
**Back** - Return to previous page.



**Forwarding A1.** Enables or disables redialing floor call (doorbell) to other devices installed in the same apartment. It is also possible to enable advanced functions (contact the technical support service of Aci Farfisa).

**Back** - Return to previous page.

## MENU DIAGRAM



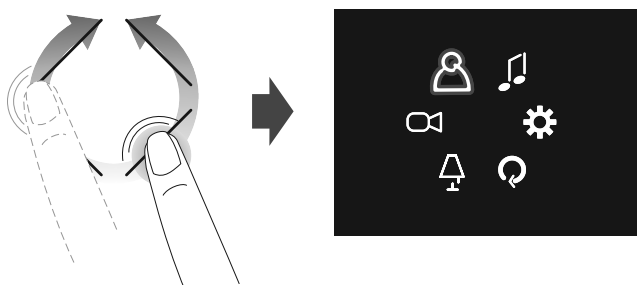
- **Intercommunicating** - List of intercommunication devices stored in the videointercom
- **Entrances** - List of entrances present in the system.
- **Actuators** - List of actuators present in the system.
- **Ringtones** - Pre-listening and assignment of ringing melodies to individual intercommunicating calls, calls from door stations and floor calls (doorbell).
- **Maintenance** - In this menu the user can modify parameters that are used more frequently and that do not compromise system operation; to modify other parameters access the "Settings" menu.
  - **Intercommunicating** - Possibility to change the name, the melody of ringtone and the sorting of intercommunicating calls in intercommunicating list.
  - **Entrances** - Possibility to change the name, the melody of ringtone and the sorting of calls from external door stations in entrances list.
  - **Actuations** - Possibility to change the name and the sorting in actuations list.
  - **Language** - List and selection of languages available.
  - **Audio** - Change sound and volume of keys and ringtone volume and duration.
  - **Video** - It enables adjusting brightness, colour and contrast of video image.
- **Settings** - This menu is reserved exclusively to qualified staff; therefore, it is protected by password.
  - **Intercommunicating** - Here the user can enter the names and addresses of intercommunication devices or to modify the data stored previously; to manage these parameters, the user must know the user and room addresses (if required).
  - **Entrances** - Here the user can enter the names and addresses of external door stations or to modify the data stored previously; to manage these parameters, the user must know the addresses of door stations.
  - **Actuations** - Here the user can enter the names and addresses of actuators or to modify the data stored previously; to manage these parameters, the user must know the addresses of actuators.
  - **Installation wizard** - This procedure enables simple setup of parameters that are essential for the operation of the device. The procedure is enabled automatically at first power-ON or it can be run later via this menu.
  - **Favourite buttons** - In this menu the user can assign direct functions to any of the 6 keys located to the side of the screen; direct functions are assigned through factory setting only to the 2 keys on bottom right (second door opening) and left (silent).
  - **System** - Here the user can set the specific parameters of the system.
    - **User address** - This is the address that enables the video intercom to receive the call coming from external door stations from door keeper exchangers or other internal intercommunicating stations. For further information refer to chapter "Programming".
    - **Room** - This is the address that enables identifying the intercommunicating devices installed in the same apartment; therefore, devices that have the same user address, but installed in different rooms. For further information refer to chapter "Programming".
    - **Supplementary addresses** - The additional addresses (maximum 10) are further addresses to which the device should answer beside its own.
    - **Forwarding A1** - Enables or disables redialing floor call (doorbell) to other devices installed in the same apartment or running advanced functions.
    - **Back** - Return to previous page.
  - **Default** - It enables resetting the factory settings of the device; if there are any intercommunicating devices, external door stations and actuators programmed, such entries will not be deleted.
  - **Advanced** - Procedures and information protected by password that can only be accesses by Aci Farfisa technical service.
  - **Show settings** - List of all actual settings.
  - **Back** - Return to previous page.
- **About** - Software version of the device.
- **Back** - Return to previous page.
- **Exit**. Exit the main menu; the monitor shuts down.

## OPERATION

### Access the main menu

With the monitor in stand-by and no other videointercom turned ON within the installation, access the menu by touching any active point of the sensor wheel.

From the main menu the user can access all programming, set-up, adjustments and activation sub-menu.



### Access the "Favourite buttons" menu (direct activation of functions)

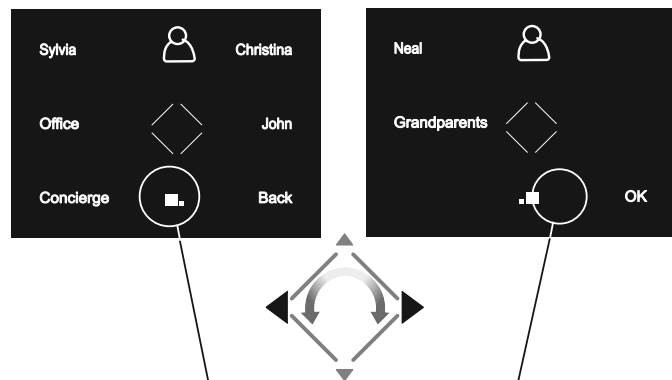
Press any one of the six buttons on the side of the screen, will appear the functions associated with each individual key (if programmed in "Favourite buttons" on page 2.9).

The image below shows the menu "buttons" with the factory settings.



The keys can activate the programmed function only when the monitor is turned ON.

### How to display next/previous functions of a page



If on middle bottom screen are displayed 2 or more boxes it means that the functions are present in several pages. Use the keys ◀▶ or rotate the wheel sensor to move from one page to another.

### Videointercom

Following an incoming call from the outside or by touching the key "||▶", on the screen is displayed an image for about 30 seconds. By touching the key "||▶" once again, it is possible to communicate to external stations for about 90 seconds.

To shut down the videointercom touch the key "||▶" or wait for the timer to expire.

The electrical lock can be operated by touching the key ◀◆; touching the keys, without receiving a call, the user operates the electrical lock of the last calling entrance.

With the videointercom image displayed, the user can adjust the audio/video parameters or select other entrances (if any), by touching the side keys.



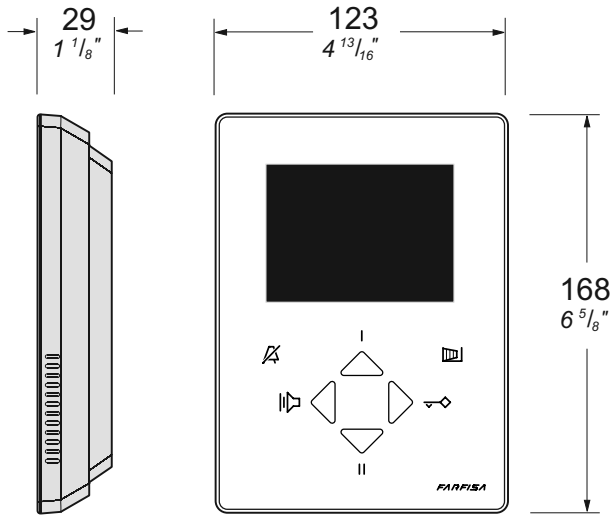
- Video settings (contrast, brightness and colour)
- Disabling/enabling videointercom microphone
- Ringtone disabling (see section "Ringtone disabling")
- Adjusting the audio and ringtone volume (attention! New the settings are permanently stored in the memory)
- List of additional services available (video cameras, actuators, etc.)
- Operating the automatic gate or supplementary video camera

### Ringtone disabling

The ringtone can be disabled instantly upon receiving an incoming call by touching the key ◀◆. At the next call, the ringtone will be enabled automatically.

To permanently disable the ringtone you must access the "Favourite buttons" and touch the key ◀◆; the symbol will flash to indicate that the ringtone has been disabled and will keep ON flashing until the ringtone will be reactivated again by the same procedure.

VIDEOINTERCOMS



**ZH1252W. Hands-free colour videointercom.**

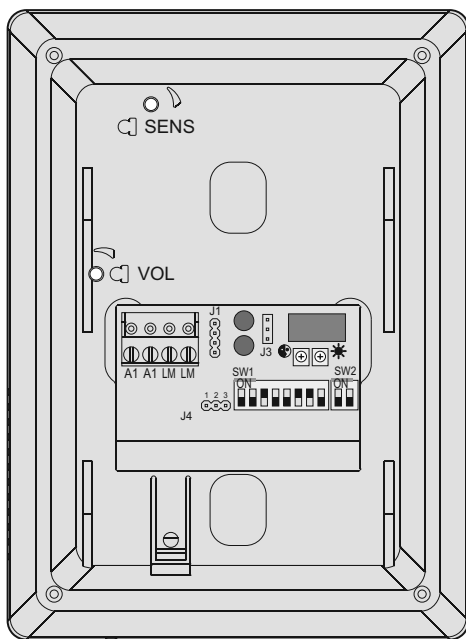
Colour videointercom with 4.0" LCD screen for DUO series. To enable the video intercom functions, 4 keys are available on the front panel; keys I and II can be used also to make intercom calls.

**Technical characteristics**

Power supply directly from the line	
Stand-by current:	6mA
Operating current:	180mA
Screen:	4.0" LCD
Operating temperature:	0° ÷ +40°C
Maximum admissible humidity:	90%RH

**Terminal boards**

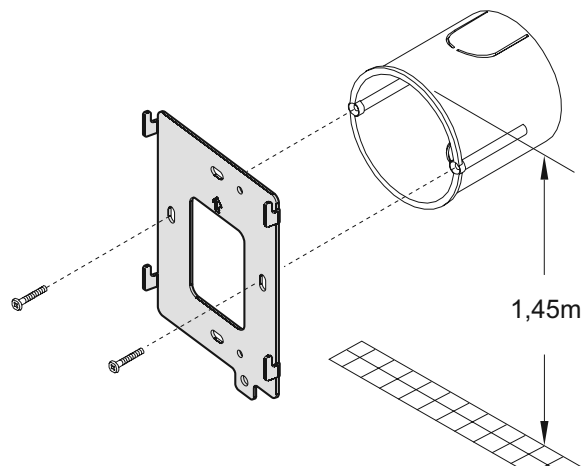
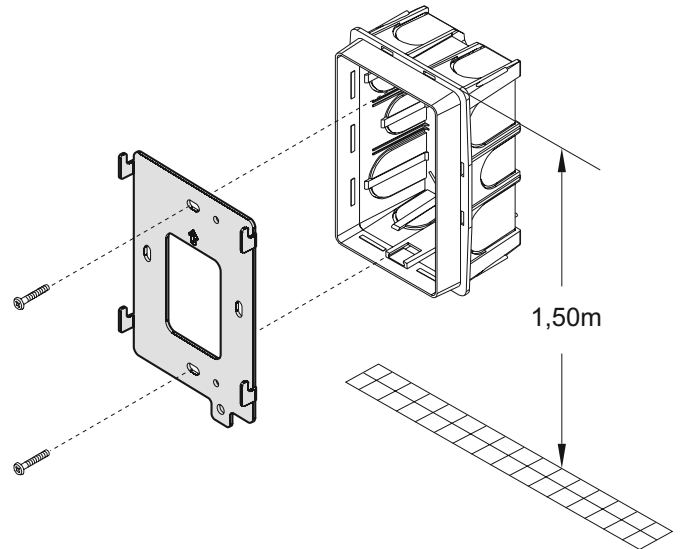
- LM/LM Line inputs
- A1/A1 Floor call input



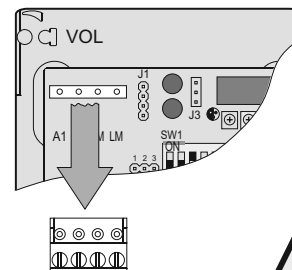
INSTALLATION

**Flush mounted version**

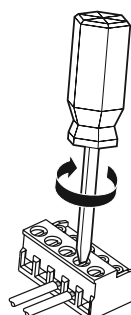
- 1 - Mount on the wall a built-in box of 83mm or 60mm at approximately 1.5 meters above the ground.
- 2 - Screw the bracket to the built-in box.



- 3 - Unplug the terminal block from the videointercom.

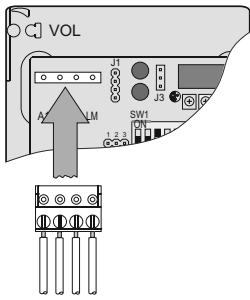


**Warning:** Do not use sharp objects to remove the terminal block

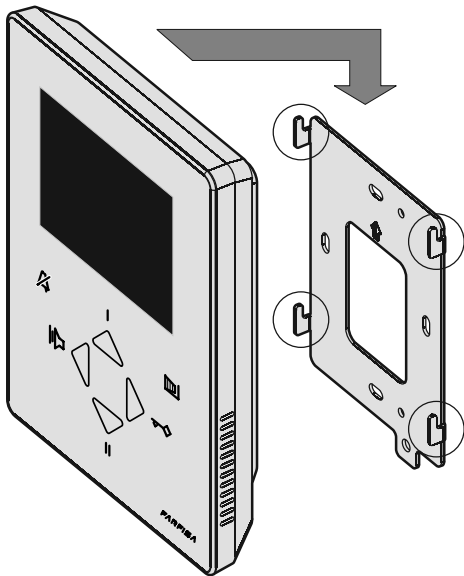


- 4 - Make the connections as required by the electric diagram.

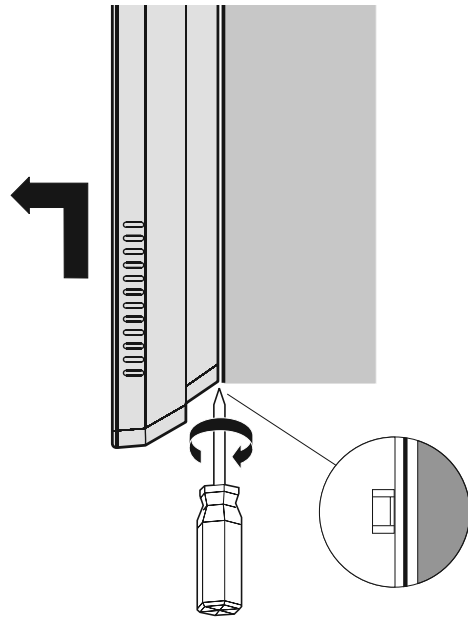
5 - Plug-in back the terminal block on the videointercom.



6 - Fix the video intercom to the wall bracket.

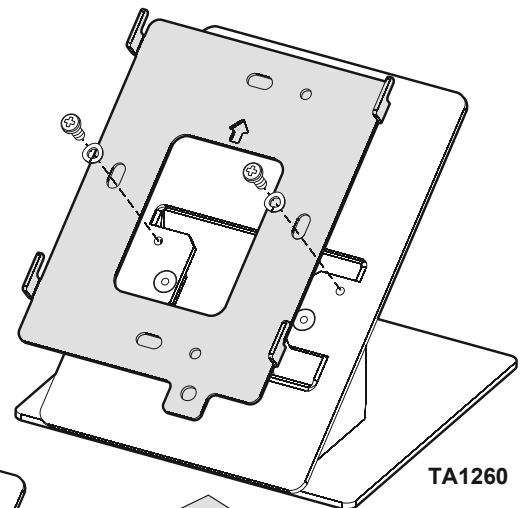


7 - Dismounting the video intercom.



**Table version**

**TA1260.** Table adapter for ZH1252W videointercom. Complete with junction box and 2.4m connection cable with 20 wires.

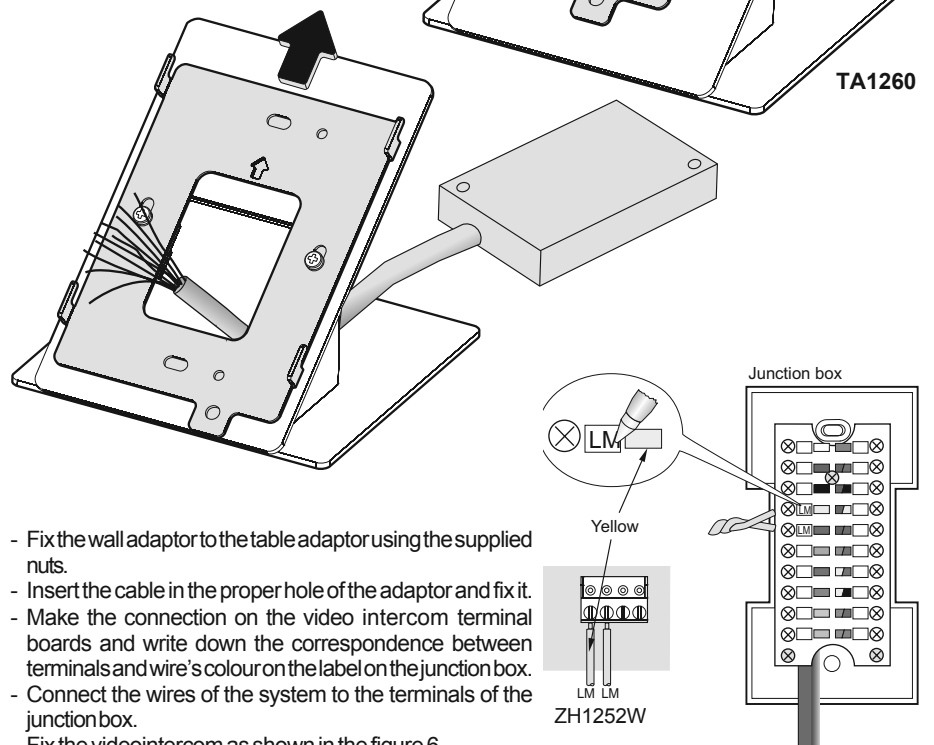
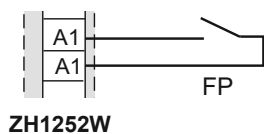


## Additional functions

### Floor call

To receive a floor call you must connect a button (FP) between terminals **A1** and **A1** of the videointercom.

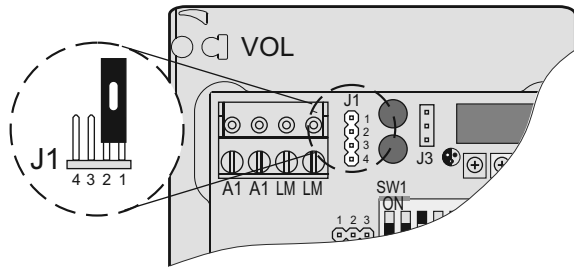
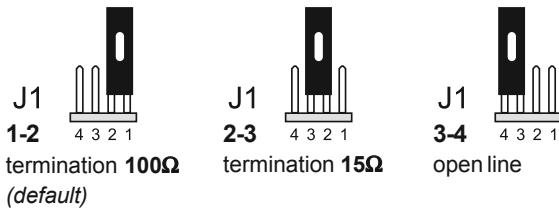
When the button FP is pressed, the videointercom speaker will receive a call different from calls from the external stations. The call is received also if the videointercom is in conversation.



- Fix the wall adaptor to the table adaptor using the supplied nuts.
- Insert the cable in the proper hole of the adaptor and fix it.
- Make the connection on the video intercom terminal boards and write down the correspondence between terminals and wire's colour on the label on the junction box.
- Connect the wires of the system to the terminals of the junction box.
- Fix the videointercom as shown in the figure 6.

## Selecting the closing impedance

The jumper **J1** provided on the back of the videointercom can be used to adjust the video signal coming from the riser and thus improve the quality of the image displayed.



## Adjustments

### Volume

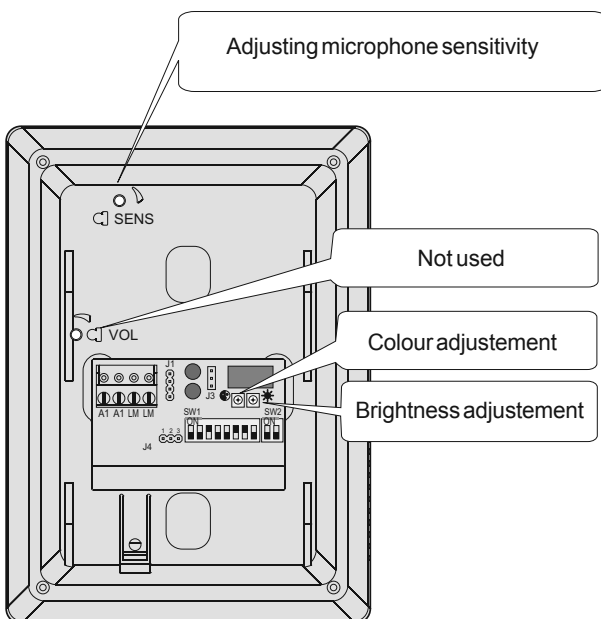
In conversation or during the call it is possible to change the volume of the audio and of the ringtone as indicated below. VOL adjustment located on the rear of the videointercom is not used.

### Microphone sensitivity

If audio is excessively intermittent during the conversation or the speaker tends to distort it during the call, it is recommended to slightly change the microphone sensitivity using the SENS trimmer on the back of the videointercom.

### Colour and Brightness

To adjust the colour and brightness of the image, turn with a small screwdriver, the trimmers located in the rear of the device.

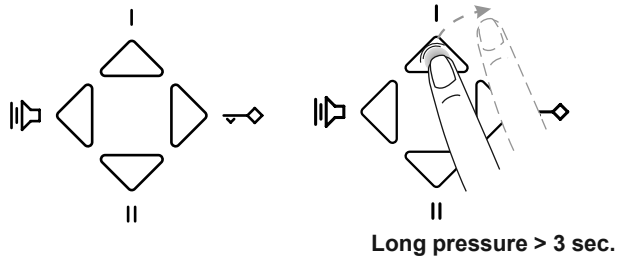


## FUNCTIONS OF THE KEYS

The 4 frontal keys allow accessing the functions and the settings of the device and vary their function depending on the operating mode of the video intercom. The keys can be used in two different ways:

- 1) short pressure
- 2) long pressure (over 3 seconds).

**Attention.** During the pressure of a key, the dissuasion or busy tone indicates that the function is not available because the service is not active or the video intercom line is busy by another user.



### Function of the keys in stand-by

In stand-by, the keys have the following functions:

#### Short pressure

The function depends on the Address stored in the pushbutton Addresses associated to the key, in detail:

- address of another apartment, the stored user is called;
- address of another room of the same apartment, the stored room is called;
- address of an actuator, the actuator is activated/deactivated;
- addresses of external stations (max. 4), at each pressure are displayed, cyclically, the images of the related external stations.

#### Long pressure

It activates/deactivates the "silent" function, exclusion of the ringtone and the tones of the device. When the "silent" function is active, related icon blinks slowly.

#### Short pressure

Same functions of key ,I except for the storing of the addresses of the external stations, which is not possible.

#### Long pressure

It is accessed to the programming menu of the ringtones; ringtone exclusion icon lights up.

#### Short pressure

It activates the electrical lock of the last external station that has made a call.

#### Long pressure

If programmed on the external station, it activates the auxiliary actuator of the last external station that has made a call.

#### Short pressure

It connects with the last external station that has made a call.

#### Long pressure

As short pressure.



## Function of the keys during a conversation

Upon arrival of a call or during a conversation, the keys have the following functions:

	<p><b>Short pressure</b> The function depends on the Address stored in the pushbutton, in detail: -address of another apartment, no function; -address of another room of the same apartment, no function; -address of an actuator, the actuator is activated/deactivated; -addresses of external stations (max. 4), no function.</p> <p><b>Long pressure</b> It activates/deactivates the "silent" function, exclusion of the ringtone and the tones of the device. When the "silent" function is active, the related icon blinks slowly.</p>
	<p><b>Short pressure</b> Same functions of key I, except for the storing of the addresses of the external stations which on key II is not possible.</p> <p><b>Long pressure</b> During the conversation it allows adjusting the audio volume: the ringtone exclusion icon lights up and there are about 3 seconds to increase (I key) or decrease (II key) the audio volume.</p>
	<p><b>Short pressure</b> It activates the electrical lock of the external station that has made a call.</p> <p><b>Long pressure</b> If programmed on the external station, it activates the auxiliary actuator of the external station that has made a call.</p>
	<p><b>Short pressure</b> It activates the audio conversation with the calling door station or intercommunicating device; if pressed once again, it terminates the conversation in progress.</p> <p><b>Long pressure</b> If it is present and programmed, it switches over on the additional camera of the door station.</p>

## SETTINGS

The parameters that follow can be modified by the user during normal use of the video intercom.

### Volume

The user can adjust the volume of the conversation by acting on keys and it is possible to adjust different levels for conversation with the external station and for the intercommunication; the adjustment takes place during the conversation and the set levels will remain valid also for the next conversations.

### Audio level with external door station

During a conversation with the external station press for a long time key ; icon lights up and there are about 3 seconds to increase or decrease the audio volume; the set level will be stored and used also for future conversations with the external station.

### Intercommunicating audio level

During an intercommunicating conversation press for a long time key , icon lights up and there are about 3 seconds to increase or decrease the audio volume; the set level will be stored and used also for future intercommunicating conversations.

## Ringtones

The user can modify the melody and the number of rings for each type of call in arrival; instead, the volume is the same for all calls.

The types of calls are:

- from external station
- from intercommunicating block of flats
- from floor
- from intercommunicating apartment

### Entering in the ringtone programming mode

With the video intercom in stand-by, press key for a long time, the ringtone programming mode is entered and icon lights up; if within 10 seconds no operation will occur, the device exits automatically from the programming mode and icon turns off.

### Select melody

The available melodies are:

- Din-don
- Classic
- High trill
- Low trill

To select the melody press repeatedly key ; the melodies will be selected in sequence and reproduced by the device; after having selected the melody, pass to the next programming.

### Adjust the ringtone volume

With keys or the volume can be lowered or raised.

**Attention:** the volume of the ringtone is the same for all types of calls.

### Setting the number of rings

Upon arrival of the call each melody can be repeated from 1 to 8 times (number of rings); to change the number of rings press repeatedly key ; at each pressure the number of rings increases by one unit; a tonality, repeated n times, will indicate the number of rings that have been selected.

### To associate the ringtone to the type of call

To end programming, it is necessary to attribute the previously selected ringtone to the type of call that can be:

- from external station
- from intercommunicating block of flats
- from floor
- from intercommunicating apartment

To associate the ringtone to the type of call, press for a long time key:

to associate it to the call from external station

to associate it to the call from intercommunicating block of flats

to associate it to the call from floor

to associate it to the call from intercommunicating apartment.

### Exit from the ringtone programming mode

Wait about 10 seconds without pressing any key; the device exits automatically from the programming mode and icon turns off.

## PROGRAMMING

To function properly, the video intercom must be programmed; if no special performance are required the only needed programming is that related to the user address, in this case pass directly to paragraph **VIDEOINTERCOM PROGRAMMING**.

**Attention:** the programming must be performed by expert (installer), incorrect programming can prevent proper operation of the entire video intercom system.


### SYSTEM PROGRAMMING

The programming that can be performed are:

- addresses associated to the key I
- address associated to the key II
- call re-launch address from floor
- secondary addresses of the video intercom

For programming, follow the methods described in the following paragraphs.

### Entering into the system programming

For accessing to the system programming jumper **J4** must be moved from position 2-3 to position **1-2**; icon  lights up.

### Addresses associated to key I

To key I can be associated 1 address of apartment and of room for intercommunicating calls, or 1 actuator address or up to 4 addresses of external stations to be able to control them in sequence.

- Programming Building Intercommunicating Address:  
with microswitches SW1 set the address of the desired apartment and with microswitches SW2 set the room number 0, press for a long time key I until a tone will confirm the occurred storing.

- Programming Apartment Intercommunicating Address:  
with microswitches SW1 set the address of your apartment and with microswitches SW2 set room number, from 0 to 3, press for a long time key I until a tone will confirm the occurred storing.

- Programming Actuator Address:  
with microswitches SW1 set the actuator address which is intended to control (from 211 to 230) and with microswitches SW2 set the room number 0, press for a long time key I until a tone will confirm the occurred storing.

- Programming External Station Addresses:  
in the key I, it is possible to programme up to 4 addresses of external stations with which it will be connected in sequence at each pressure of the key. With micro-switches SW1 set the address of the first external station, and set 0 on microswitches SW2, press for a long time key I until a tone will confirm the occurred storing of the first address. If it is intended to programme a second address, it is necessary to set microchips SW1 with the address of the second external station leaving at 0 microswitches SW2 and press for a long time key I until two tones will confirm the occurred storing of the second address. Proceed in a similar manner to the programming of the third and fourth external station address, the occurred programming is confirmed respectively by three or four tones.

To change the stored addresses, it is necessary to exit from the programming, wait 3 seconds and re-enter in programming; with SW1 set the new address, leaving SW2 at 0 and press for a long time key I until a tone will confirm the occurred storing of the new first address; proceed in a similar manner to change the eventual second, third and fourth address.

To delete the stored addresses, it is necessary to set code 255 on SW1 and 0 on SW2 and press for a long time key I until a tone will confirm the occurred cancellation of the first address; proceed in a similar way to cancel any second, third and fourth stored address.

### Addresses associated to key II

To key II can be associated 1 address of apartment and of room for intercommunicating calls, or 1 actuator address.

- Programming Building Intercommunicating Address:  
with microswitches SW1 set the address of the desired apartment and with microswitches SW2 set the room number 0; press for a long time key II until a tone will confirm the occurred storing.


- Programming Apartment Intercommunicating Address:  
with microswitches SW1 set the address of your apartment and with microswitches SW2 set room number, from 0 to 3; press for a long time key II until a tone will confirm the occurred storing.

- Programming Actuator Address:  
with microswitches SW1 set the actuator address that it is intended to control (from 211 to 230) and with microswitches SW2 set the room number 0; press for a long time key II until a tone will confirm the occurred storing.



To change the stored address, it is necessary to set with SW1 and SW2 the new codes and press for a long time key II until a tone will confirm the occurred storing; instead to delete the stored address, it is necessary to set code 255 on SW1 and 0 on SW2 and press for a long time key II until a tone will confirm the occurred cancellation.

### Forwarding a floor call

Upon arrival of a call from a floor, only the monitor to which the call pushbutton is connected rings. If it is intended to relaunch the call also on all the other monitors present in the apartment or in another apartment, it is necessary to proceed as follows:



- with microswitches SW1 set the address of the main video intercom of the apartment to which it is intended to forward the floor call and with microswitches SW2 set the room number 0, press for a long time key  until a tone will confirm the occurred storing.



**Attention:** when forwarding a floor call, all video intercoms (both main and secondary) present in the apartment to which the floor call was forwarded will ring.

To change the stored address, it is necessary to set with SW1 and SW2 the new codes and press for a long time key  until a tone will confirm the occurred storing; instead, to delete the stored address, it is necessary to set code 255 on SW1 and 0 on SW2 and press for a long time key  until a tone will confirm the occurred cancellation.


## Additional Addresses

A video intercom can be enabled to receive also the calls addressed to other users (max 4); for the programming of the relative addresses it is necessary to proceed as follows:

- with microswitches SW1 set the address of the first user for whom it is desired to answer and with microswitches SW2 the relative room number; press for a long time key  until a tone will confirm the occurred storing of the first address. If it is intended to programme other additional addresses, it is necessary to set microswitches SW1 with the address of the second user for which it is desired to answer and microswitches SW2 with the relative number of room; press for a long time key  until two tones will confirm the occurred storing of the second address. Proceed in a similar way for the programming of the address of the third and fourth user for which it is desired to answer; the occurred programming is confirmed respectively by three or four tones.







To change the stored addresses, it is necessary to exit from the programming, wait 3 seconds and re-enter into the programming; set with SW1 and SW2 the new codes and press for a long time key  until a tone will confirm the occurred storing of the new first additional address; proceed in a similar way to change the eventual second, third and fourth address. To delete stored addresses, it is necessary to set code 255 on SW1 and 0 on SW2 and press for a long time key  until a tone will confirm the occurred cancellation of the first address; proceed in a similar manner to cancel any second, third and fourth stored address.

## Exit from the system programming

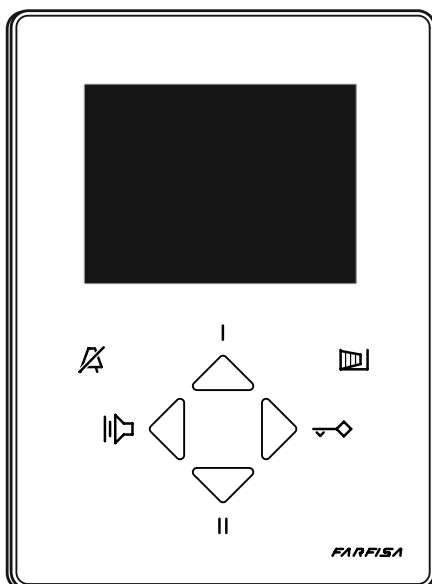
To exit from programming, jumper J4 must be taken from position 1-2 to position 2-3, icon  will turn off.

## Restore factory settings

To restore default factory settings, you must:

- Access programming mode;
- Press in sequence keys     ;
- the  icon flashes for 1 second and the  icon turns OFF, the device settings and system programming are returned to the default factory settings;
- exit the programming mode.

Front view (icons and keys).




## VIDEOINTERCOM PROGRAMMING

For programming of the device it is necessary to set the codes that identify the video intercom respectively inside the plant (user addresses from 001 to 200) and inside the apartment (room number from 0 to 3).

### For user address keep in mind that:

- it must not be the same number of another apartment; if more internal stations in parallel are in the apartment, they must have the same user address but different room number;
- it must coincide with the number stored in the external keyboard and in the possible reception switchboard;
- it must be stored in the key call or in the device contacts of another user if it is necessary to intercommunicate between the two apartments.

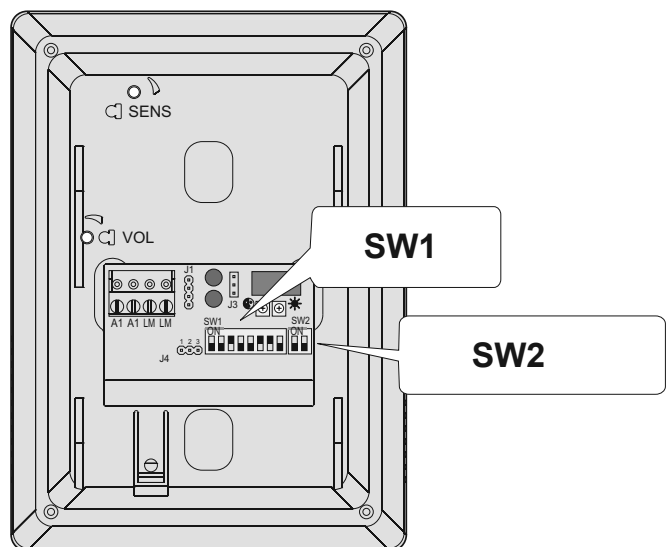
### For the number of room, keep in mind that:

- the number of room establishes also a hierarchy in the internal device, as the device that will have room number 0 (zero) will be defined as the main, while all others will be secondary;
- the different number of room allows carrying out and selectively receiving calls between devices within the same apartment; the calls from outside or from another apartment will ring up all the devices, the first to answer will activate the conversation and will turn off the ringtones of the others;
- upon arrival of a call from an external video intercom station, all the devices will ring, but only the main (number of room 0 "zero") shows the image of the camera. From the other video intercoms of the same apartment, it is possible to view the entry by pressing key . This operation deactivates all ringtones, turns on the video intercom and simultaneously turns off the main video intercom.

### User Address and number of room.


To program the address and the room number of the video intercom no procedure is needed, just place microswitches SW1 and SW2 in accordance with the table on page 2.19; (from factory the video intercom is programmed with user address 100 and room number 0).

**Attention:** since microswitches SW1 and SW2 are used to perform also other programming, their position may have been changed. Before using the device remember to position microswitches SW1 and SW2 in accordance with the user address and the room number that it is intended to be given to the video intercom.





## OPERATION



### Video Intercom

Following a call from the external station, the video intercom rings and on the screen appears the image for about 30 seconds. By pressing key  it is possible to converse with the outside for about 90 seconds.



During the conversation, to turn off in advance the video intercom, press key .

The electrical lock is activated by pressing key ; the command operates also without receiving any call. In this case is operated the electrical lock of the last door station that has made a call or that was activated.



During a video intercom conversation, by pressing for a long time key , there is the possibility to adjust the audio volume.

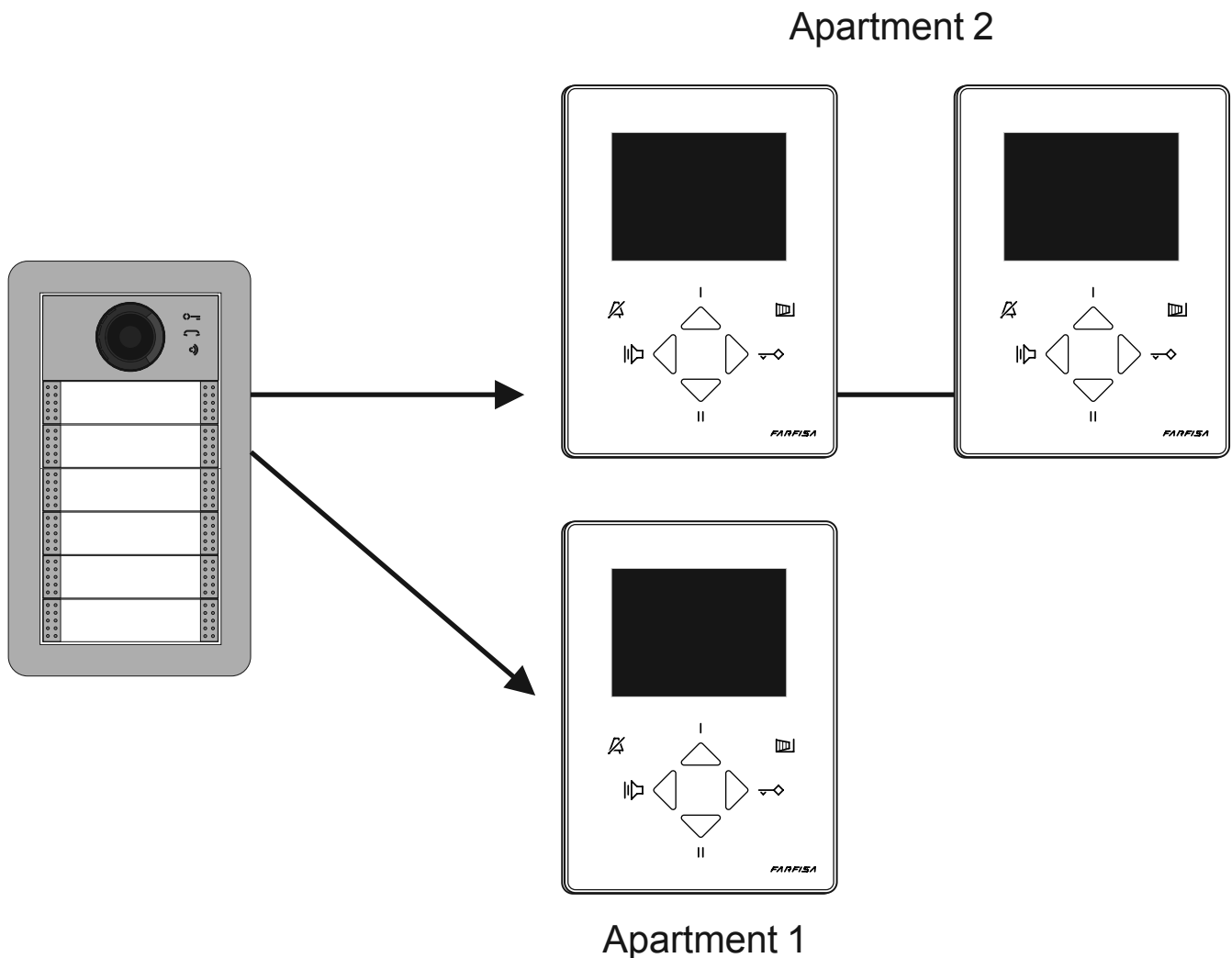
With the monitor in stand-by, by pressing key , is viewed the image incoming from the last external station that has made a call. By pressing key , if properly programmed, are viewed images incoming from other external stations, if present in the installation (max 4). For programming of the keys see paragraph System programming.

### Intercommunicating

With keys  and , if properly programmed, other devices present in the same apartment or in the same building, can be called. For programming of the keys see paragraph System programming.

### Ringtone deactivation

The ringtone can be deactivated by pressing for a long time key ; symbol  blinks to indicate the ringtone deactivation and will continue to blink until the ringtone will be reactivated in a similar way to that for deactivation.



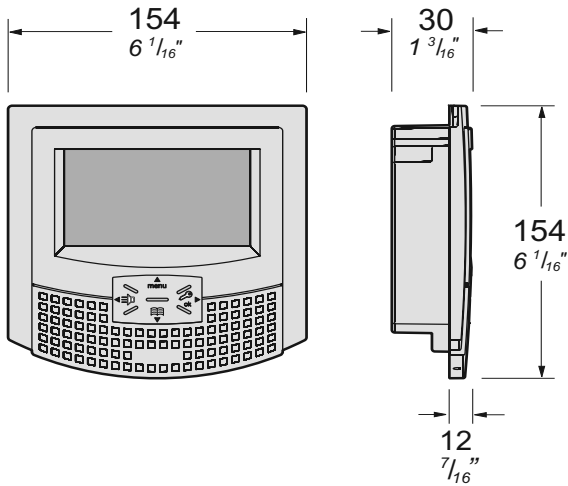
**Address  
SW1**

0	1	2	3	4	5	6	7
8	9	10	11	12	13	14	15
16	17	18	19	20	21	22	23
24	25	26	27	28	29	30	31
32	33	34	35	36	37	38	39
40	41	42	43	44	45	46	47
48	49	50	51	52	53	54	55
56	57	58	59	60	61	62	63
64	65	66	67	68	69	70	71
72	73	74	75	76	77	78	79
80	81	82	83	84	85	86	87
88	89	90	91	92	93	94	95
96	97	98	99	100	101	102	103
104	105	106	107	108	109	110	111
112	113	114	115	116	117	118	119
120	121	122	123	124	125	126	127
128	129	130	131	132	133	134	135
136	137	138	139	140	141	142	143
144	145	146	147	148	149	150	151
152	153	154	155	156	157	158	159
160	161	162	163	164	165	166	167
168	169	170	171	172	173	174	175
176	177	178	179	180	181	182	183
184	185	186	187	188	189	190	191
192	193	194	195	196	197	198	199
200	201	202	203	204	205	206	207
208	209	210	211	212	213	214	215
216	217	218	219	220	221	222	223
224	225	226	227	228	229	230	231
232	233	234	235	236	237	238	239
240	241	242	243	244	245	246	247
248	249	250	251	252	253	254	255

**Room number  
SW2**



VIDEOINTERCOMS



**ML2002C.** Hands-free colour video intercom with OSD technology for display of the programming, set-up and usage information on the screen enabled by 4 "function" buttons. White colour with audio-video privacy, intercommunicating service, control switch-ON of multiple door stations, differentiated programmable ring tones, audio, contrast, and brightness adjustment. It can be installed on the wall by using the wall-bracket art. **ML2083** or wall adaptor **WA2160**.

**ML2083.** Back box for videointercom **ML2002C**.

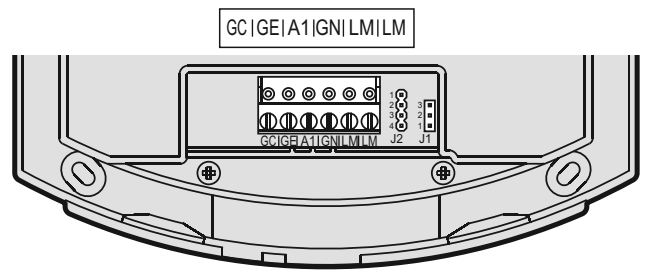
**MC2000T- MC2000W.** Plastic front panels in silver and white colour respectively for the ML2002C. Can replace the white ones supplied with the video intercom.

Technical characteristics

- Power supply directly from the line
- Stand-by current: 8mA
- Operating current: 0.3A
- Screen: 4.3" LCD
- Television standard: PAL
- Horizontal frequency: 15625Hz
- Vertical frequency: 50Hz
- Band width: >5MHz
- Starting up time: 1 second
- Operating temperature: 0° + 50°C
- Maximum admissible humidity: 90%RH

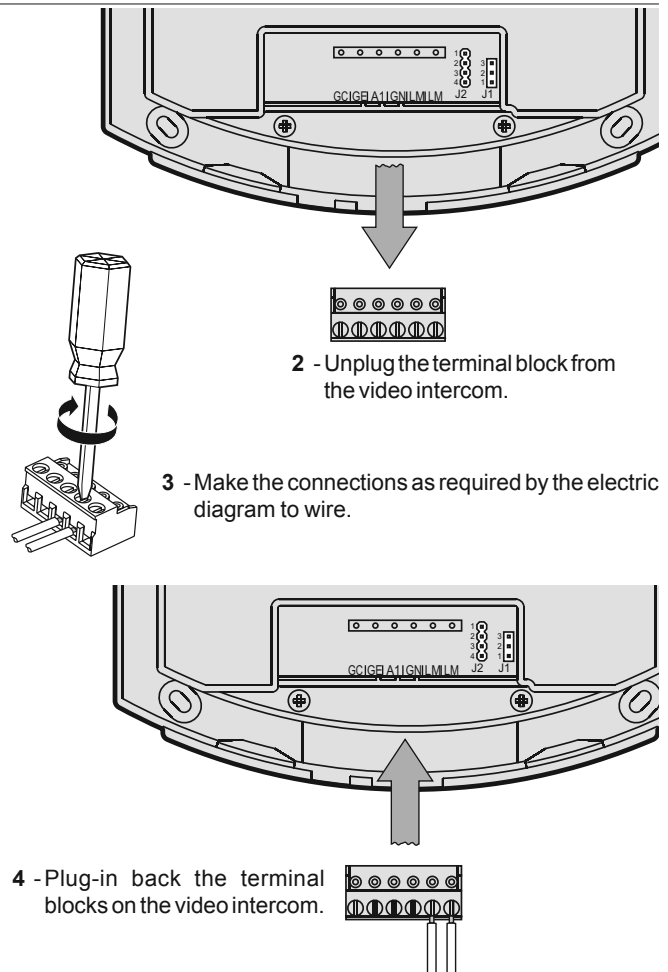
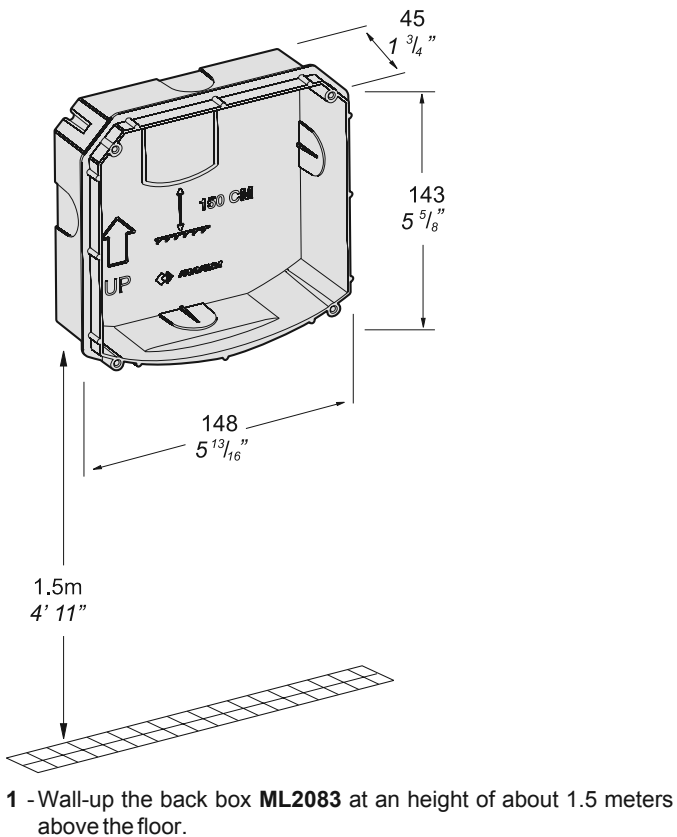
Terminal boards

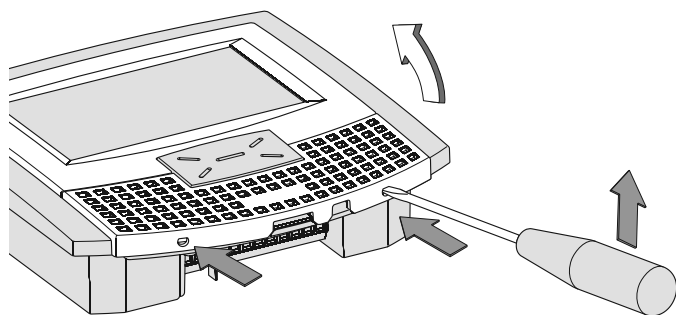
- LM/LM** Line inputs
- A1** Floor call positive input
- GN** Floor call negative input
- GC** Positive output for additional functions
- GE** Negative output for additional functions



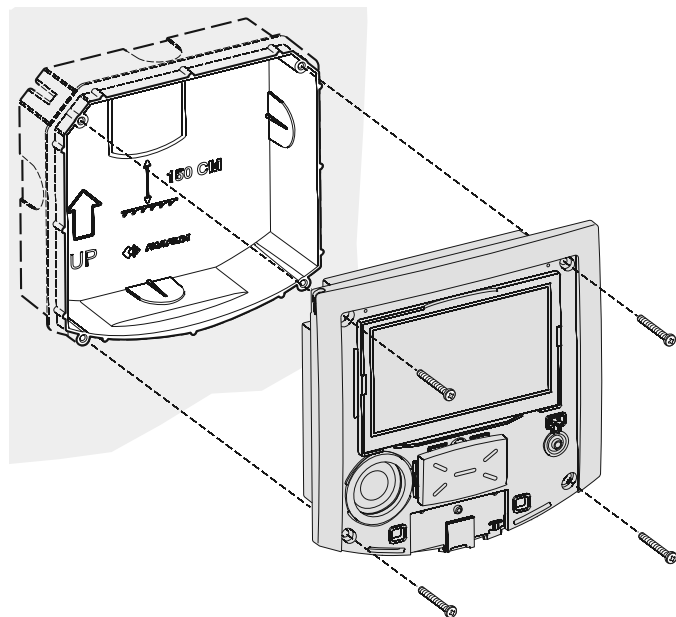
INSTALLATION

Flush mounted version

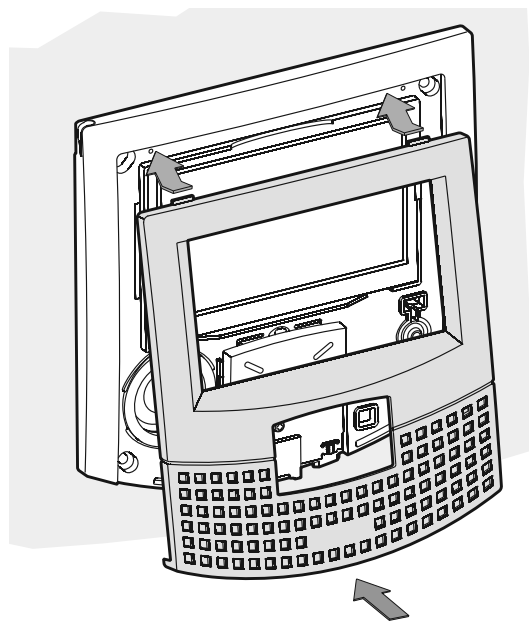




5 - Remove the frontal plastic frame to approach the four fixing points of the video intercom.



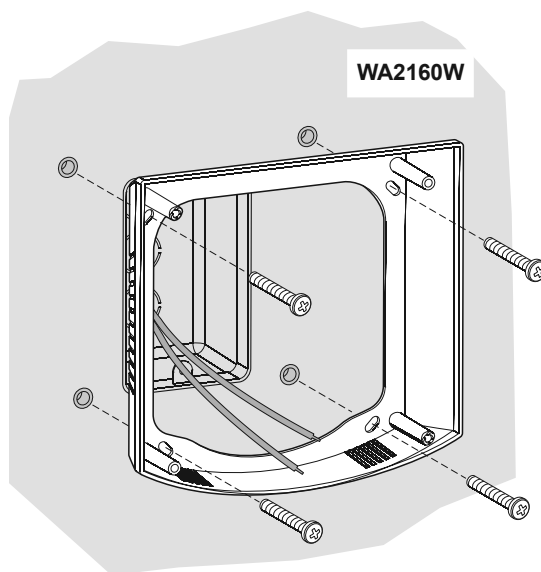
6 - Fix the video intercom to the back-box using the four screws supplied with the product.



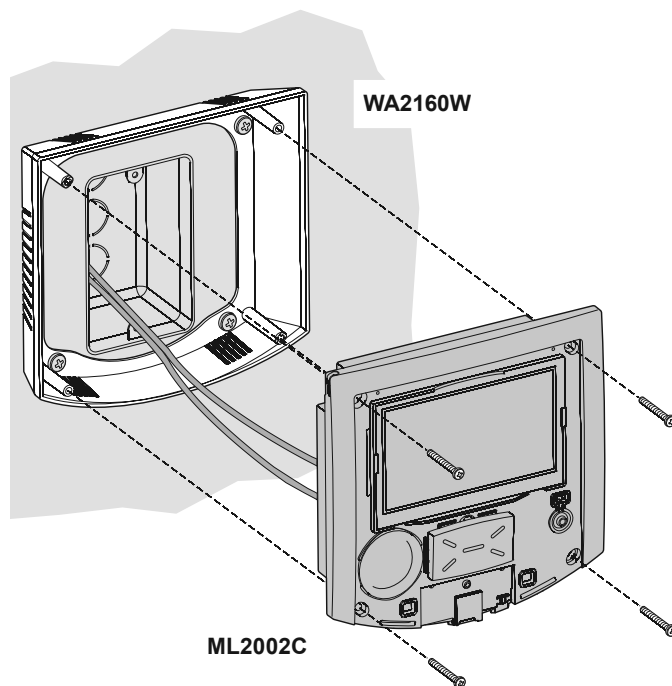
7 - Re-insert the frontal plastic frame to the video intercom.

## Surface mounted version

WA2160W. Wall adaptor for the ML2002C videointercom.



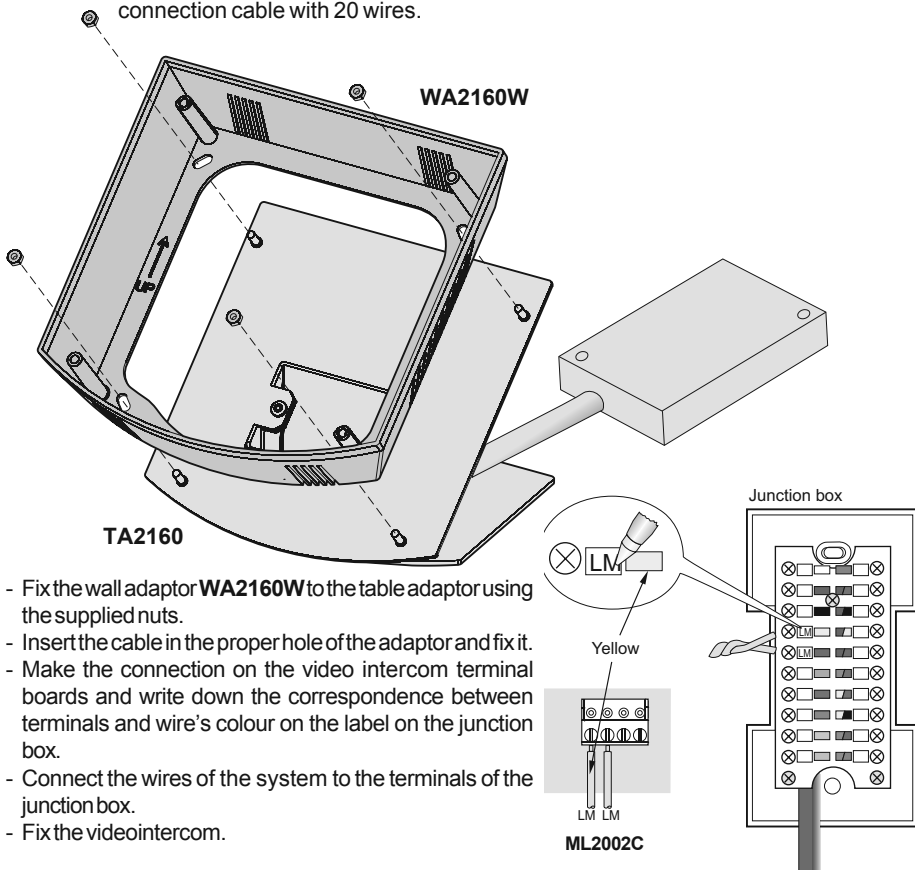
1 - Fix the adaptor to the wall with 4 expansion plugs at approx. 1.5m from the floor.



2 - Fix the video intercom to the wall adaptor using the four screws supplied with the product.

## Table version

**TA2160.** Table adapter for **ML2002C** videointercom. Complete with junction box and 2.4m connection cable with 20 wires.



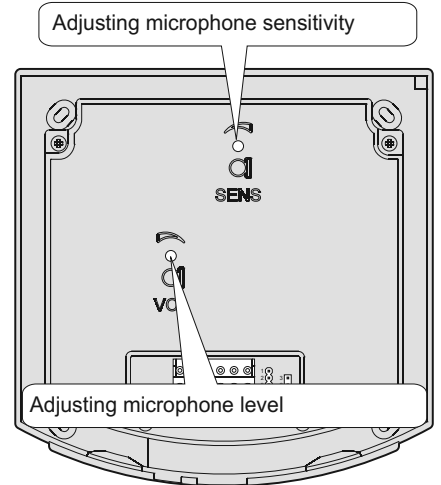
- Fix the wall adaptor **WA2160W** to the table adaptor using the supplied nuts.
- Insert the cable in the proper hole of the adaptor and fix it.
- Make the connection on the video intercom terminal boards and write down the correspondence between terminals and wire's colour on the label on the junction box.
- Connect the wires of the system to the terminals of the junction box.
- Fix the videointercom.

## ADJUSTMENTS

The audio levels are set in the factory; settings on the back of the device must be changed only if really necessary.

### Setting the sound levels.

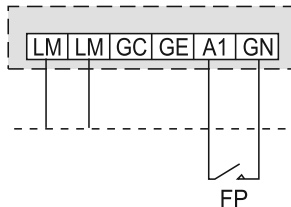
- If audio is excessively intermittent during the conversation or the speaker tends to distort it during the call, it is recommended to slightly change the microphone sensitivity using the **SENS** trimmer on the back of the video-intercom.
- In case of problems in getting the line in one of the two directions, slightly increase the level of the disturbed channel and decrease the level of the other channel using the **VOL** trimmer for the microphone volume and the menu buttons for the speaker volume (see chapter "Audio-video adjustment").



## Additional functions

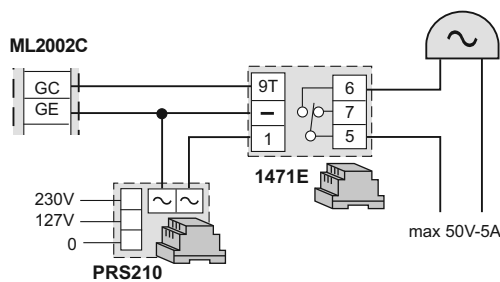
### Call floor

To receive a floor call you must connect a button (FP) between terminals **A1** and **GN** of the videointercom. When the button FP is pressed, the videointercom speaker will receive a call different from calls from the external stations. The call is received also if the videointercom is in conversation.



### Call repeater

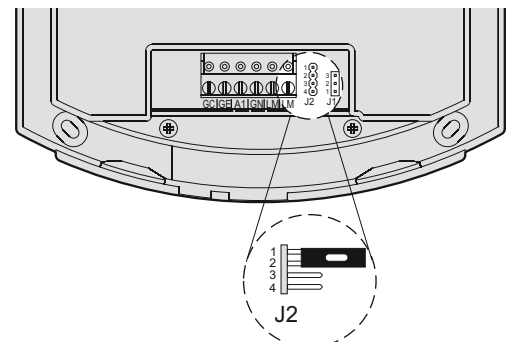
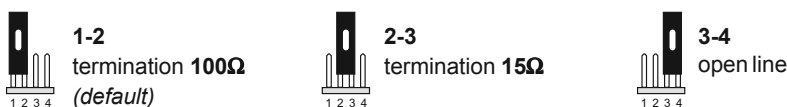
To relaunch the call of the videointercom in other parts of the apartment add a relay 1471E and a transformer PRS210.



## Selecting the closing impedance

Videointercoms are provided on the back with a jumper **J2** that, when set in the correct position, readjusts the signal coming from the riser to ensure the correct operation of the connected systems.

### J2 Jumper to select impedance termination line



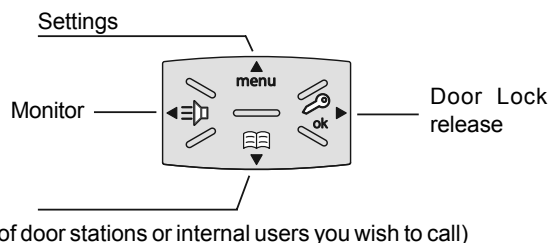


## MAIN FUNCTIONS OF BUTTONS

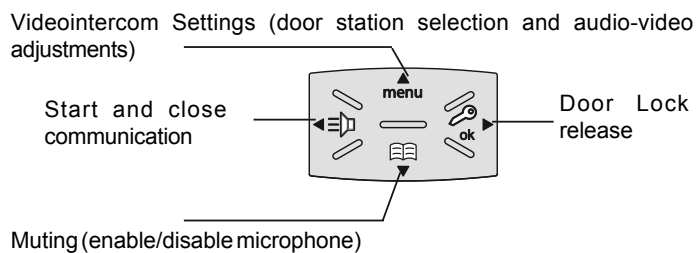
The 4 buttons, located on the front of videointercoms, allow to access the operating modes, settings and programming of the videointercom. The functions of the buttons vary according to the operating mode of the videointercom.

**Attention.** A dissuasion tone, while pressing a button, means the function is not available because the service has not been enabled, or the intercom line is busy.

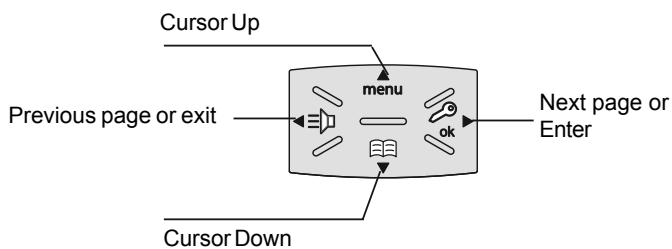
### Videointercom in Stand-By mode (Display OFF)



### Videointercom ON and connected to the videointercom line



### Videointercom ON during setting or programming phase



### Menu

By pressing the menu button it is possible to enter the programming, settings and adjustment functions of videointercoms. Present settings are displayed in green.

## PROGRAMMING

At the first start-up, the videointercom must be suitably programmed to define its operating mode. A wrong programming can affect negatively the operating of the whole system.

The possible programming ways are two:

- **remote** - it allows to quickly program only the user address of the intercom by making a call from the door station or the digital doorkeeper exchanger (refer to the "remote programming");
- **manual** - it allows to program all the parameters, by operating directly on the videointercoms (refer to the "system").

### Programming

● **User address** (*mandatory*); apartment identification address (*addresses from 1 to 200*). It allows to receive an external call or a call from another device installed in the same building, switch-ON the videointercom, have a conversation and open the door lock of the calling external door station. The address must be the same address saved in the call button of the push-button panel of the external door station or in the call button of another intercom device of the building.

● **Room number** (*mandatory in case of multiple devices in the same apartment*); identification address of a device inside the same apartment (*addresses from 0 to 7*). The room number establishes a hierarchy in the internal devices since the device with room address 0 (*zero*) will be the main device and all the other devices will be the secondary lines. Once you have made this programming, you will be able to make and receive selective calls with the other devices inside the same apartment. In other words, each device can individually call the other devices. The external calls or calls from another apartment will make all devices ringing, the first device that answers the call will activate the conversation and switch OFF the ringer of the other devices. When you receive a call from an external door station equipped with camera, all the devices will ring, but only the main device (*room address 0 - zero*) will display the camera image. In this phase you can display the camera image also from a secondary videointercom without answering by pressing the camera button "≡". This operation will switch OFF the ringer of all the devices and will display the camera image on the display of the used videointercom. To answer the call it is sufficient to press again the button "≡". A floor call makes ringing only the videointercom to which the call button is physically connected. To forward the call to the other videointercoms you must follow the instructions contained in the section "A1 Forward".





- **Contacts**; it is possible to save the **name** and the **address** of:
- users of other apartments; it allows to call them selectively (*addresses from 1 to 200*);
  - videointercoms in the same apartment; it allows to intercommunicate with the equipment of other rooms in the same apartment (*room number from 0 to 7*);
  - door stations (not necessary in the case of a single door station); it allows the videointercom to connect them selectively, monitor the entrance and eventually release the door lock (*addresses from 231 to 250*);
  - actuators for supplementary services (supplementary door lock release, switch-ON of stair's light, etc.); it allows the videointercom to enable directly the actuators (*addresses from 211 to 220*).

**Warning:** the addresses stored in the videointercom must be the same of those programmed in the devices to enable.

## Factoring settings

User address = 100  
 Room address = 0  
 Secondary addresses = none  
 Contacts = ingresso 231

## Function of buttons during system settings and programming

-  Cursor Up
-  Previous page or exit
-  Cursor Down
-  Next page or Enter

## Enter system programming mode

**Attention.** To enter the programming mode it is necessary that **all the videointercoms** in the installation (including the one to be programmed) **are switched OFF**. If pressing the “menu” button a dissuasion tone is heard, it means the above condition is not met.

With the display switched OFF (without images or running conversations), keep pressed the “menu” button for about 4 seconds; a confirmation tone will be emitted and the “settings menu” is displayed, showing the following contents:


Settings	
▶	Contacts
	Audio
	System
	Language
	Fontsize

Pay attention, if the pressure of the button is too short (less than 4 seconds), the “user menu” will be displayed instead. Wait a few seconds or press button ◀ to exit and then try again.

Previously programmed parameters are in green.

**Warning.** During the programming phase the display could switch OFF suddenly for the following reasons:

- a call from a door station to any videointercoms in the system has been made;
- from any videointercom in the system the monitor function or a call to another has been made;
- no operations on the videointercom for about 20 seconds.

● **Contacts** - In the contacts list, which can be displayed pressing the  button, can be stored up to 30 names and addresses of intercommunicating devices, door stations and actuators for supplementary services (example: Living Room – 1; Robert Brown – 104; Oxford Street Entrance – 231; car gate – 211). Every category is represented with a different colours of characters.

Move the cursor to “Contacts” and press **OK**; the list of the following functions will be displayed: New, the list of names (if any), Sorting.

Contacts	
▶	New
	Entrance
	Sorting

## - Insert (or modify) the name and address of a user.

-Select “new” and press **OK**; the following functions will be displayed: Label, Address, Room, Ring tone, Room, Ring tone, Delete.



- **Label** – select “Label” to enter the name (max. 16 characters, upper and lower cases, numbers or symbols) you want to give to the device (example: Living Room; Robert Brown; Oxford Street entrance; car gate). Insert the name using the buttons ▼▲ to search the characters (keep them pressed for fast searching) and press **OK** to confirm; cursor automatically moves to the next character to enter. Search the 2<sup>nd</sup> character and confirm by pressing **OK**; repeat the same procedure to complete the name and press **OK**; press **OK** again to exit and display the “save” menu: select “cancel” to move back to the label page – select “save” to exit and store the name – select “don’t save” to exit without saving it.



**Note.** While entering the names, if you need to correct it, use buttons ◀▶ to move from one character to another.

## - Address –

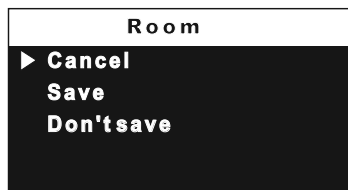
move the cursor to “Address” – press **OK**; the present address is shown (100 from the factory) – keep pressed buttons ▼▲ to increase or decrease the number of the address-press **OK** to confirm; the “save” menu is displayed: select “cancel” to move back to the “Address” page – select “save” to exit and store the new address–select “don’t save” to exit without saving it.



**Attention:** the address stored in the contacts list must be the same address stored in the device you want to call (eg.: 104 address of Mr. Brown’s videointercom; 231 address of Oxford street’s door station; 211 address of car gate’s actuator).



- **Room** - it is shown only if there are intercommunicating devices in the same apartment (having therefore all the same user address) the room number must be changed; to change it operate as indicated in the following: –move the cursor to “Room” – press **OK**; the present room number is shown (0 from the factory) – keep pressed buttons ▼▲ to increase or decrease the number of the room - press **OK** to confirm; the “save” menu is displayed: select “cancel” to move back to the “Room” page – select “save” to exit and store the new room number –select “don’t save” to exit without saving it.



- **Ringing Melody** - it is possible to assign to any user a personal ringing melody, to make this programming it is necessary: – move the cursor to “Ringing Melody” – press **OK**; the list of available ringing melodies are displayed (in green the present assigned ringing melody). Use buttons **▼▲** to scroll the list and hear the melody; press **OK** to select the desired one.



To insert other user names repeat all the above operations. If, in the contacts list, it is necessary to store 2 users with the same address (eg. wife and husband; apartment and professional office, etc.) it is sufficient to create 2 users with different names but the same address.

### Modify a name or address.

To modify the data of a user it is sufficient, in the “contacts” menu, select the name and press **OK**; the following list will be displayed: Label, Address, Room, Ringing Melody, Delete; select the requested item and press **OK**; proceed as indicated in the chapter “insert name and address of a user”.

### Cancel a name and address from the contacts list.

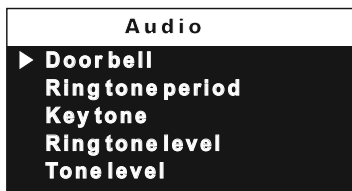
To delete a user from the list it is necessary to select the name and press **OK**; using buttons **▼▲** select “Delete” and press **OK**; the “save” menu is displayed: select “cancel” to exit without erasing the name or select “confirm” to erase it than press **OK**. Press **◀** one time to go back to the previous page or several times to exit the programming mode.

### Sorting

To change the order of the names in the contacts list it is necessary, once in the menu “contacts”, select “Sorting” and press **OK**; select the name you want to move and press **OK** – with the buttons **▼▲** move the name up or down in the list until you reach the desired position and press **OK** to confirm. Press **◀** to go back to the previous page.

### ● Audio

It allows to chose the sound of door bell, the volume and period for all the ringing melodies and for the tones of pressed keys. In the settings menu select “Audio” and press **OK**; the following menu will be displayed: Door Bell (only for “floor call” – A1 terminal), Ring tone period, Key tone, Ring tone level, Tone level.



- **Door bell** – select “Door bell” and press **OK**; with buttons **▼▲** select the desired bell sound and press **◀** to confirm and exit.

- **Ring tone period** – select “Ring tone period” and press **OK**; with buttons **▼▲** increase or decrease ringing melody repetition period (from 0 to 255 seconds) and press **OK**; the “save” menu is displayed: select “Cancel” to go back to the previous page – select “Save” to save and exit – select “don’t save” to exit without saving the data.

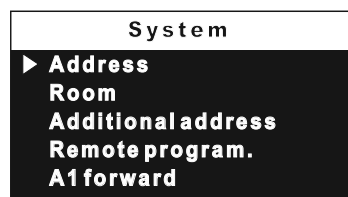
- **Key tone** – it allows to activate (enable) or deactivate (disable) the tone while pressing the buttons of the videointercom. Select “Key tone” and press **OK**; with buttons **▼▲** select “enabled” or “disabled” and press **OK** to confirm; press **◀** to go back to the previous page.

- **Ring tone level** – it allows to increase (**▲**) or decrease (**▼**) the volume of all the ringing melodies of the videointercoms. Select “Ring tone level” and press **OK**; on the right side of the screen a vertical graphic bar will be displayed and the present level will be heard. With buttons **▼▲** select the desired level of volume and press **OK** to confirm and go back to the previous page.

- **Tone level** – it allows to increase (**▲**) or decrease (**▼**) the volume of all the tones of the videointercoms. Select “Tone level” and press **OK**;

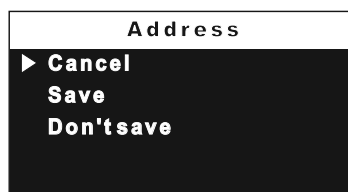
on the right side of the screen a vertical graphic bar will be displayed and the present level will be heard. With buttons **▼▲** select the desired level of tones and press **OK** to confirm and go back to the previous page.

- **System** – Move the cursor to “System” and press **OK**; the main settings menu of the videointercom will be displayed with the following functions: Address, Room, Additional address, Remote program, A1 forward.



### - User Address (addresses from 1 to 200)

- Move the cursor to “Address” – press **OK**; the previously programmed address will be shown (100 from the factory) – keep pressed the button **▼** or **▲** to increase or decrease the number of the address – once displayed the requested address press **OK**; the “save” menu is displayed: select “cancel” to move back to the address page – select “save” to exit and store the new address – select “don’t save” to exit without saving it.



### - Room number (from 0 to 7)

- Move the cursor to “Room” – press **OK**; the previously room number will be shown (0 from the factory) – keep pressed the button **▼** or **▲** to increase or decrease the number of the room – once displayed the requested room number press **OK**; the “save” menu is displayed: select “cancel” to move back to the room number page – select “save” to exit and store the new room number – select “don’t save” to exit without saving it.



### - Secondary addresses

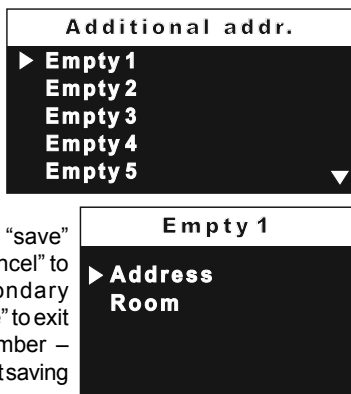
You can set the videointercom so that it answers the calls sent to other users (secondary addresses); for example, the house of a professional and his professional office, or parents’ apartment and sons’ apartment. In this way the videointercom of an apartment can operate as a videointercom, either main or secondary, of another apartment. It is important to remember that, in case of a videointercom with alternative address, the videointercom operates as a videointercom of its own apartment, but also as videointercom of the alternative apartment so that it must respect also the rules and programming operations of the latter.

Example. If the room number 2 is already used in the alternative apartment, the alternative videointercom cannot be programmed with room number 2. Of course, it can be room number 2 of its own apartment, if available. If there is a main videointercom in the alternative apartment, the alternative videointercom cannot be programmed as main videointercom, it can be the main videointercom for its own apartment if requested.

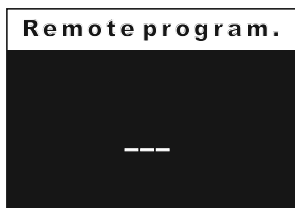
To program the “secondary address” function you must proceed as indicated below:

– move the cursor to “secondary addresses” – press **OK**; 10 empty labels will be displayed if no one has been previously programmed – select the first empty one and press **OK**; select “address” and press **OK**; keep pressed the button **▼** or **▲** to increase or decrease the secondary address (addresses from 1 to 200) – once displayed the requested address press **OK**; the “save” menu is displayed; select “cancel” to move back to the page “secondary addresses” – select

“save” to exit and store the new address – select “don’t save” to exit without saving it;  
 - select “room” - press **OK**; – keep pressed the button **▼** or **▲** to increase or decrease the room number (from 0 to 7) – once displayed the requested room number press **OK**; the “save” menu is displayed; select “cancel” to move back to the secondary addresses page – select “save” to exit and store the new room number – select “don’t save” to exit without saving it.



**- Remote programming** – The user address of the videointercom can be programmed from remote making a call from a door station or a digital Doorkeeper exchanger.  
 - Move the cursor to “Remote programming” – press **OK**; within 2 minutes make a call from the door station or the digital Doorkeeper exchanger to the address to be stored. In systems with the digital keypad TD2100, key in the address to be stored and press “**▲**”; in systems with the digital encoding module CD2131, CD2132, CD2134 or CD2138, press the button you want to assign to the videointercom under programming; in systems with the digital doorkeeper exchanger PDX2000, pick up the handset, key in the address to be stored and press “**←**”. Automatically the videointercom will ring, press the button “**☰**” to communicate with the calling device and check the correct operations of the system; the calling device will emit an acknowledge tone if remote programming has been accepted or a dissuasion tone if remote programming has been refused.



- Repeat the above described operations for all the videointercoms in the system.

**- A1 forward.**

Upon a floor call, only the videointercom with terminals A1 and GND connected to the chime button will ring. To forward A1 signal to all the other videointercom of the apartment it is necessary to operate as in the following:

- select “A1 forward” and press **OK**; select “disabled” to avoid the forwarding of A1 command to other videointercoms or “enabled” to forward A1 command.

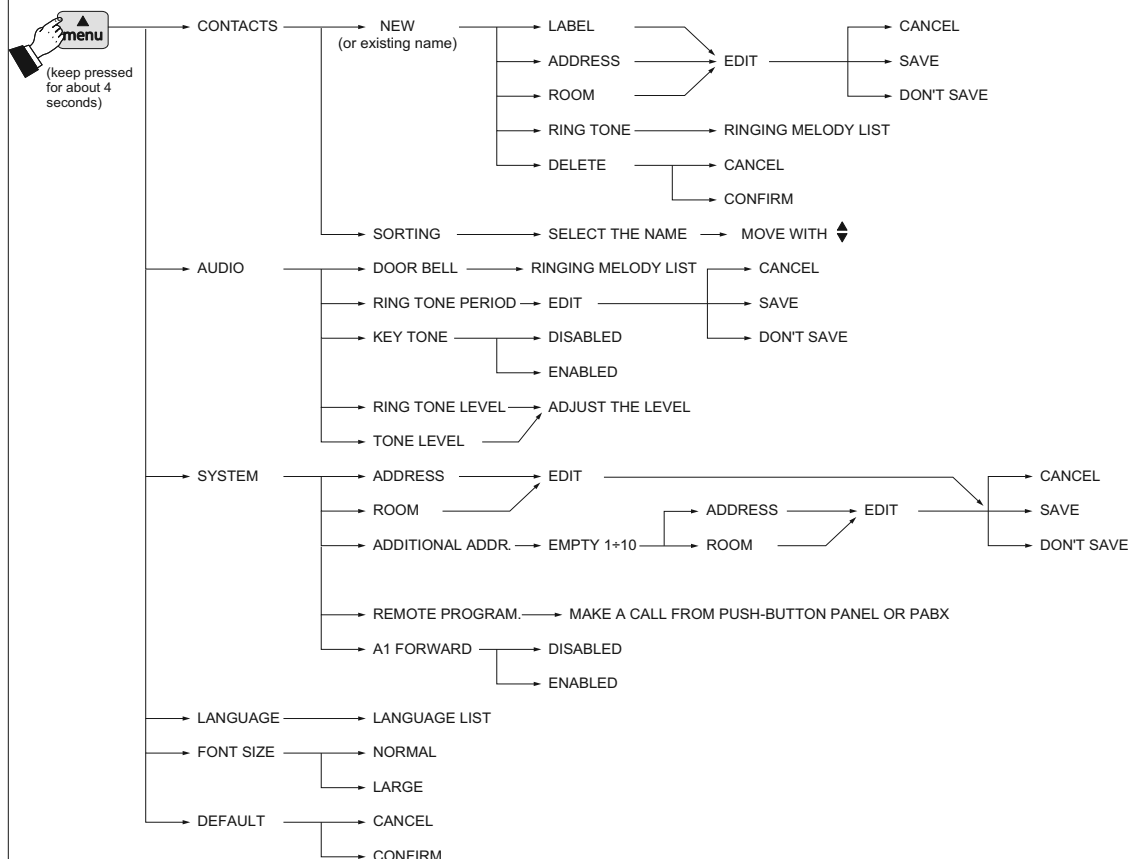
Press **OK** to confirm and **←** to exit.

- **Language** – Move the cursor to “Language” and press **OK**; list of available languages is displayed, scroll the list with buttons **▲▼** - select the requested language and press **OK** to confirm; press **←** to move back to the previous page.



- **Character**  
It allows to increase or decrease the size of characters on the screen. Select “Character” and press **OK** – select large or normal size and press **OK** – press **←** to go back to the previous page.
- **Default** – Back to the factory settings.  
**This command erase all the settings previously stored (except contacts) and restore the videointercom back to the factory settings.**  
Select “Default” and press **OK**, the “save” menu is displayed: select “cancel” and press **OK** to go back to the previous page without restoring data – select “confirm” and press **OK** to restore the videointercom to the factory settings.  
Press **←** to exit the programming page.





## PROGRAMMING MENU



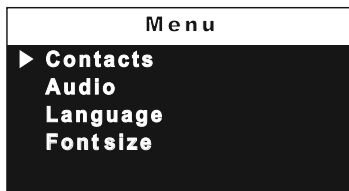
## USER SETTINGS

The following settings can be changed by the user without affecting the correct operations of the videointercom or of the whole system. User can change: - user name in the contacts – volume levels of ringing melodies and tones – ringing melodies – language – character size on the screen.

### Function of buttons during user settings

-  **menu** Cursor Up
-  **ok** Previous page or exit
-  Cursor Down
-  Next page or Enter

While the videointercom is OFF, press shortly the "menu" button (less than 4 seconds); user menu is displayed: Contacts, Audio, Language, Font size.



- **Contacts** – In contacts, if programmed during the installation of the videointercom, are listed the name of users, door stations and actuators whose sorting, ringing melody and name can be changed. Move the cursor to "Contacts" and press **OK**; the list of users (eg. *Mr. Robert Brown, Oxford street entrance, Car gate*) and the "Sorting" option are displayed.



To change a name and the associated ringing melody it is necessary to select the name to change using buttons **▼▲** and press **OK**; functions label and ringing melody are displayed.



- **Label** – select "Label" to change the name (eg. from "Mr. Robert Brown" to "Uncle Robert"); press buttons **◀▶** to move to the character to change, keep pressed buttons **▼▲** to quickly search the new character and press **OK**; automatically the cursor moves to the next character; continue until all the corrections have been made and press **OK**. Press **OK** again to exit the page; the "save" menu will be displayed: select "clear" to go back, select "save" to exit saving the new name, select "don't save" to exit without saving the new name.



- **Ring tone** – move the cursor to "Ring Tone" – press **OK**; list of available ringing melodies is displayed (in green the present one). Use buttons **▼▲** to scroll the list and hear the melodies – press **OK** to select the desired one – press **◀** to exit.



Repeat all the above operations to change other user names or press **◀** to exit.

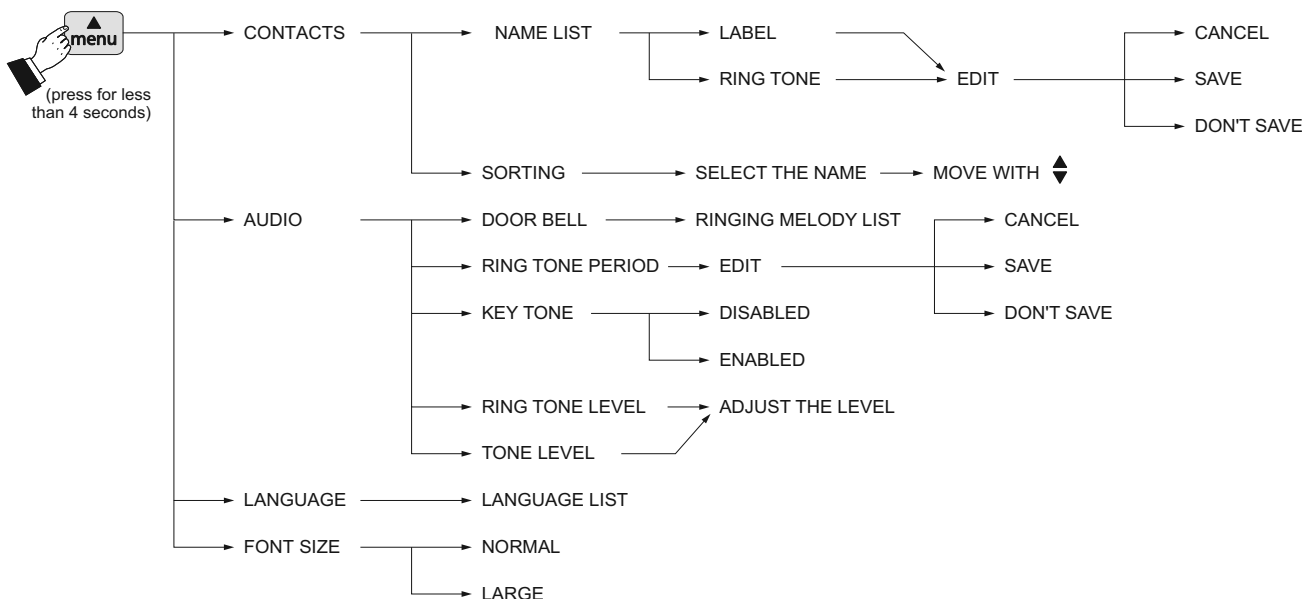
### Sorting of names

To change the order of names in the contact list it is necessary to select "Sorting" in the "Contact" menu and press **OK** – select the name to move and press **OK** – with **▼▲** buttons move the name up or down until it reaches the desired position and press **OK** to confirm.

Press **◀** to go back to the previous page.





- **Audio** .
- **Language** .
- **Font size**

## SET UP MENU







## OPERATION


### Function of buttons with videointercom in stand-by (screen OFF)


-  Settings
-  Door Lock release
-  Contacts (list of door stations or internal users you wish to call)
-  Monitor



### Function of buttons with videointercom ON and connected to the videointercom line

-  Videointercom Settings (door station selection and audio-video adjustments)
-  Door Lock release
-  Muting (enable/disable microphone)
-  Start and close communication



### Call from the door station

When a call is made from the external door station, the videointercom starts ringing (according to programming), the calling user is displayed on the screen for around 30 seconds. If time has expired and the videointercom turns OFF, press the button  to reconnect with the external door station.


To start the conversation with the external door station, for around 90 seconds, press the button .

If it is desired to disable the audio to the door station, but continuing hearing the audio from the door station, press shortly the button ; while audio is disabled on the screen it is shown, in flashing mode, the symbol .


To restore the audio to the door station, press again the button ; the symbol  disappears from the screen.

In case of a call to a user with more than one videointercom in parallel in the same apartment, all the videointercoms will ring, but only the videointercom with room address 0 will turn ON. To answer from this videointercom follow the instructions above. It is also possible to answer from any other videointercom of the apartment by pressing on it button ; this videointercom will turn ON and at the same time the intercom that had been turned ON before, switches OFF. If, after having seen the image, you wish to talk with the calling door station, press again the button .

To operate the electric door lock release press the button .

To end the communication and switch OFF the videointercom press the button . The videointercom switches OFF automatically also when the communication time expires.

### Monitor function and connection with one or more external door stations.


With the system in stand-by and no any conversation in progress, it is possible to monitor the external door stations by pressing the button  on the videointercom.


If the installation includes more external door stations to monitor them selectively it is necessary to press the button "menu"; from the list select the requested entrance and press button **OK**. Pay attention to

press the button only once because a second pressure of this button will activate the door lock release.

The monitor function lasts about 30 seconds, but will be interrupted in case of a call from an external door station.

Monitor function can be executed also selecting the entrance to monitor from the list:

Press button  – select the entrance – press **OK** to confirm.


If pressing the button  (or **OK** when selecting the door station from the list) the videointercom remains switched OFF and a busy tone is heard, the system is busy and it is necessary to wait until the system becomes free.

If a supplementary camera is connected to the door station, to switch the signal between the 2 cameras it is necessary to: -press button "menu" – select "camera" - press button **OK** (any time you press button **OK** the image switches from one camera to the other).

**▶ Camera Entrance Gate Settings**

### Making or receiving a call from another user or from another device in the same apartment.


When the installation is in stand-by, you can make an intercommunicating call to another user or to another device in the same apartment; you must have stored the names and address of the desired users or devices in the "Contacts" list.



Display the contact list by pressing button , from the list select the requested user or device and press the button **OK**; on the screen appears the name of the user and you will hear a calling tone to confirm the call has been made; if you get a busy tone, wait until the system becomes free.

The videointercom of the other user will ring (without switching-ON) with the programmed melody. If the called user answers within 30 seconds, a 90-second conversation starts, otherwise the system goes back to free.

The internal conversation will be automatically interrupted in case of call from external door station to any other user.

### Audio-video adjustments

To adjust audio and video parameters it is necessary that the videointercom will be ON and connected to an external door station after a call from the door station or a monitor function (button .

Press "menu"; the following list will be displayed: camera, list of entrances or services (if previously stored – see paragraph "contacts"), settings. Select "settings" and press **OK** – select "volume" to adjust, pressing buttons , the volume level (loudspeaker) or select "video" to adjust contrast, brightness and colour of the image.

If the videointercom, instead of communicating with the door station is intercommunicating with another user, pressing "menu" only audio adjustments are displayed (because there is no image on the screen).

**▶ Camera Entrance Gate Settings**

Settings

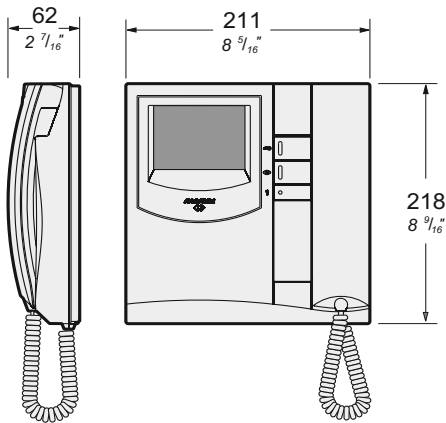
**▶ Audio level Video**

**▶ Gate Settings**

Settings

**▶ Audio level**

VIDEOINTERCOMS



**EX3252C.** Colour videointercom with 4" LCD, private audio-video function, electronic microphone, differentiated double electronic ringing sounds (modulated and continuous) and terminal board for the connection to the wall bracket. Equipped with 3 buttons for camera control switch ON, door-open and various services.

The videointercom can be fixed to the wall (flush-mounted) with the **WB3252** bracket or on the table with the **TA3160** adaptor.

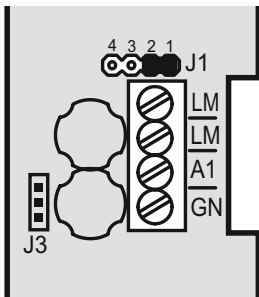
**Technical characteristics**

- Power supply directly from the line
- Stand-by current: 6mA
- Operating current: 0.23A
- Screen: 4" LCD
- Television standard: PAL
- Horizontal frequency: 15625Hz
- Vertical frequency: 50Hz
- Band width: >5MHz
- Starting up time: 1 second
- Operating temperature: 0° ÷ +50°C
- Maximum admissible humidity: 90%RH

**WB3252.** Wall bracket for **EX3252C** video intercoms with terminal boards for connection to the system.

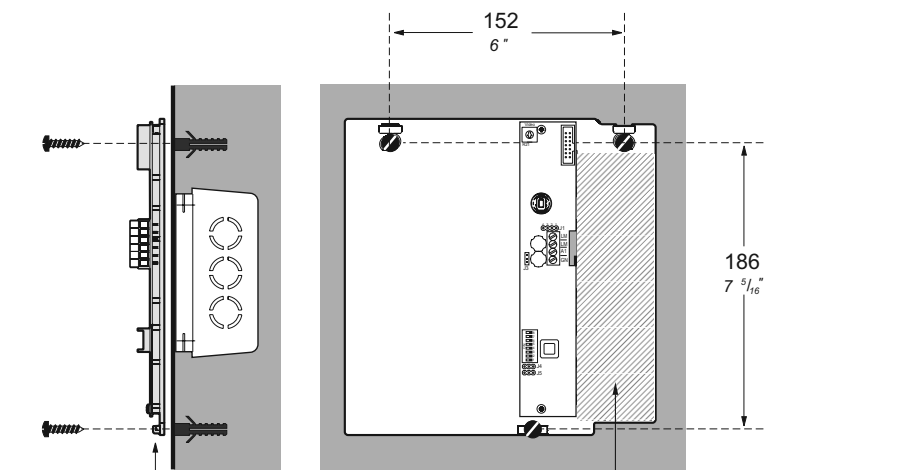
**Terminals**

- LM/LM** Line inputs
- A1** Floor call positive input
- GN** Floor call negative input



INSTALLATION

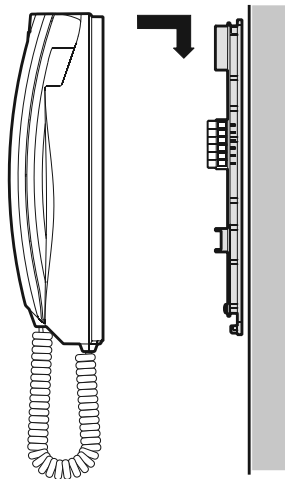
Flush mounted version



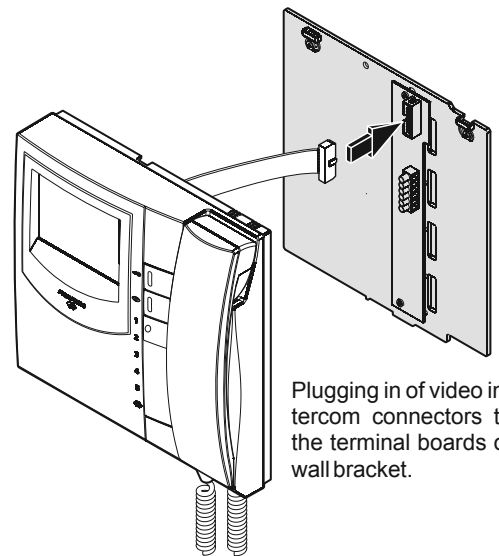
- This area has to be free; to move possible present cables.

140 ÷ 150 cm  
4' 7" ÷ 4' 11"

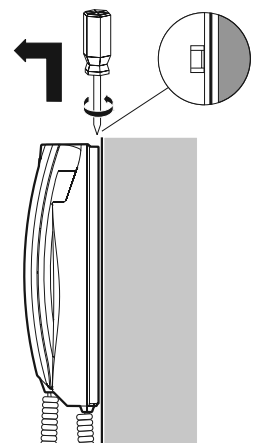
Fix the bracket to the wall with 3 screws.  
Don't shut the 3 screws of fixing if the wall is irregular.  
It is suggested to use a wall box to contain the extra wires.



Installation of video intercom onto the wall bracket.



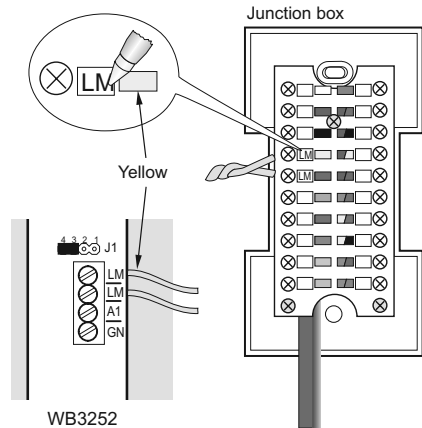
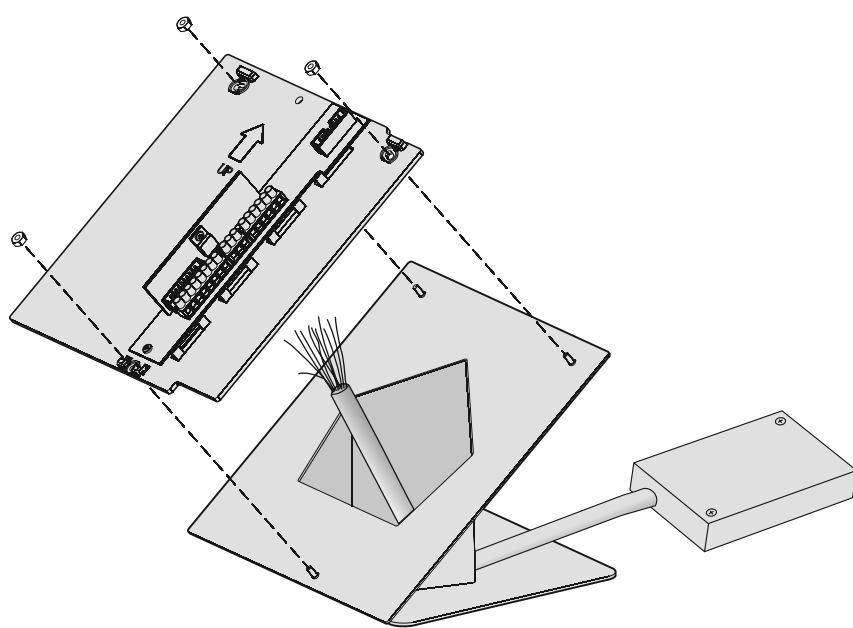
Plugging in of video intercom connectors to the terminal boards of wall bracket.



Dismounting of videointercom from the wall bracket.

## Table version

**TA3160. Table adapter** complete with junction box and 2.4m connection cable with 20 wires.

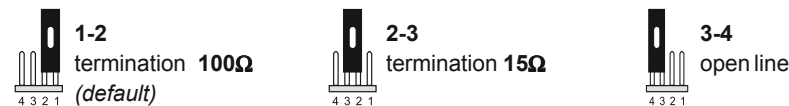


- Remove the cover to the junction box.
- Make the connection on the video intercom terminal boards and write down the correspondence between terminals and wire's colour on the label on the junction box.
- Connect the wires of the system to the terminals of the junction box.
- Fix the videointercom.

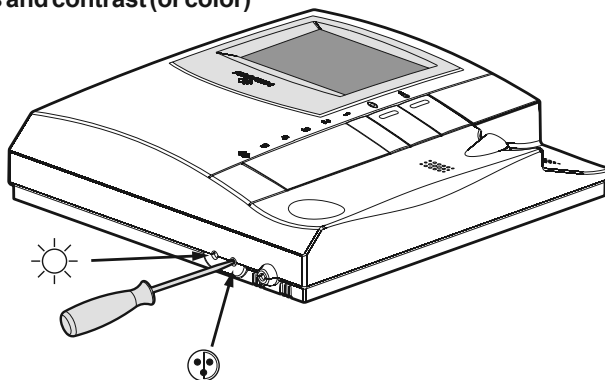
## Selecting the closing impedance

The wall bracket **WB3252** are provided with the jumper **J1** that, when placed in the correct position, allows to readapt the signal from the riser for the correct operation of the connected devices.

### J1 Jumper to select impedance video signal



## Adjusting brightness and contrast (or color)



## PROGRAMMING

The videointercom must be suitably programmed for operation.

The following programming is possible:

- **user address**; through micro-switches on the WB3252 bracket;
- **internal address**; through jumpers on the WB3252 bracket;
- **secondary address**; it allows you get the call addressed to another user;
- **address to assign to button** "☺"; maximum 4 addresses of external door stations;
- **address to be assigned to button "1"** to make intercom call, 2<sup>nd</sup> door station monitoring or for special services;
- **supplementary function to be assigned to terminal A1** besides with the floor call service.
- **selection of the call timing and call melody** normally for 4 different call melodies

**Attention: it is mandatory** to program the equipment only with the **user address** all other programming are optional.

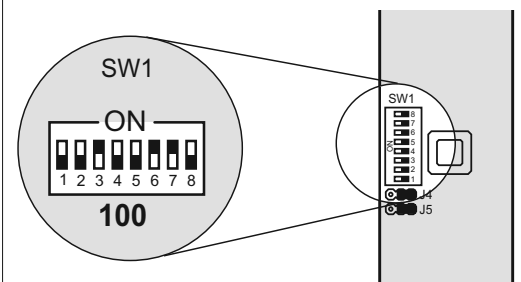
### Factory setting

- **user address** = 100
- **internal address** = 000
- **button "☺"** = no code is stored to the button
- **button "1"** = 211
- **number of call rings and call melody**

● **User address (mandatory)**; address that identifies the video intercom in the system. Enter a number from 1 to 200 keeping in mind that:

- it must not be the same number of another apartment; if more stations in parallel are present in the apartment, they must make the same user address, but different internal address (please refer to the next paragraph);
- it must match the address stored in the external door station and in the doorkeeper exchanger (if any);
- it must be stored in the call button and in the contacts of another user's device if the two apartments need intercommunication.

For coding you need to set appropriately the **SW1 micro-switches**. See the table on the next page for the correct correspondence between the number and the position of the micro-switches. From the factory the bracket is encoded with address 100 as shown in the figure.





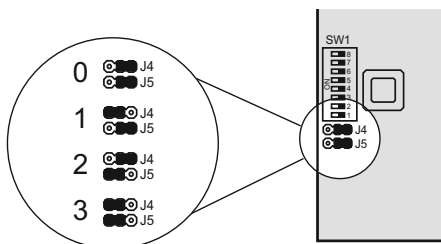
**Table 2.5. Cross-reference between user address and microswitches position.**

1		2		3		4		5		6	
7		8		9		10		11		12	
13		14		15		16		17		18	
19		20		21		22		23		24	
25		26		27		28		29		30	
31		32		33		34		35		36	
37		38		39		40		41		42	
43		44		45		46		47		48	
49		50		51		52		53		54	
55		56		57		58		59		60	
61		62		63		64		65		66	
67		68		69		70		71		72	
73		74		75		76		77		78	
79		80		81		82		83		84	
85		86		87		88		89		90	
91		92		93		94		95		96	
97		98		99		100		101		102	
103		104		105		106		107		108	
109		110		111		112		113		114	
115		116		117		118		119		120	
121		122		123		124		125		126	
127		128		129		130		131		132	
133		134		135		136		137		138	
139		140		141		142		143		144	
145		146		147		148		149		150	
151		152		153		154		155		156	
157		158		159		160		161		162	
163		164		165		166		167		168	
169		170		171		172		173		174	
175		176		177		178		179		180	
181		182		183		184		185		186	
187		188		189		190		191		192	
193		194		195		196		197		198	
199		200									



● **Internal address** (mandatory in case of multiple devices in the same apartment); identification address of a device inside the same apartment (addresses from 0 to 3). The internal address establishes a hierarchy in the internal devices since the device with internal address **0 (zero)** will be the main device and all the other devices will be the secondary ones. The different internal address allows you to selectively make and receive calls between devices within the same apartment. The external calls or calls from another apartment will make all devices ringing, the first device that answers the call will activate the conversation and switch OFF the ringer of the other devices. When you receive a call from an external video door station, all the devices will ring, but only the main device (internal address 0 - zero) will display the camera image. Even from other video intercom devices in the same apartment you can monitor the entrance by pressing the button; this operation turns OFF all ringers, turns ON the video intercom device and simultaneously turns OFF the main one.

For the coding it is necessary to set the **J4** and **J5** jumpers according to the internal address required (see the following figure). From the factory the bracket is encoded as standard with internal address **0** (both jumpers to the right).



### Additional programming

After powering up the video intercom system, if necessary, it is possible to program the secondary addresses and apply the codes to be assigned to the , buttons and the **A1 terminal**.

### Entering codes or addresses

Press button "1", and to enter addresses or codes.

1 : Press this button to **increase the value you want to enter**. Press the button for a number of times equal to the digit you want to enter (digit 1 = 1 time; digit 9 = 9 times; digit 0 = 10 times).

: Press this button to **confirm the digit just dialled** and to proceed to enter next digit in the following order: hundreds, tens, units.

: Press this button to **confirm address or code programming** or go to the next programming step.

- Codes and/or addresses must have three digits (hundreds, tens, units); codes and/or addresses with tens and units or units only must be completed by adding zeros. For example, address 96 will become 096 and address 5 will become 005.
- Digits must be entered individually (beginning from the hundred), by pressing the button "1" for a number of times "n", where "n" is the value of the digit you want to enter. Store the digit pressing the button ; a tone will confirm the acquisition of the 1<sup>st</sup> digit.
- Follow the same procedure to store the 2nd and 3rd digit.

For example, to enter code 096 you must:

- press button "1" 10 times to enter digit 0 and press the button ; you will hear a tone;
- press button "1" 9 times to enter digit 9 and press the button ; you will hear a tone;
- press button "1" 6 times to enter digit 6 and press the button ; you will hear a tone.

### Enter the programming phase

- Hold the button pressed, after 4 seconds you will hear a beep, pick up the handset keeping pressed button , the programming tone will be heard.
- Release the button keeping the handset OFF hook until the end of programming.

**Attention.** If for 2 minutes no keys are pressed, system switches back to the **operating mode**.

### Exit the programming phase

You can exit the programming phase at any time by replacing the handset.

### Programming of the secondary address.

- **Secondary user address** - By storing the user address of another apartment it is possible to receive both the calls (call addressed to its own videointercom and call addressed to the other apartment), talk to the external station and actuate the lock of the external station calling (i.e.: videointercom installed in common area for several users, etc.).

To program the **secondary user address** it is necessary to:

- enter the **programming mode** following the instructions described in "Enter the programming phase";
- keep pressed the button for more than 4 seconds; the programming tone will be heard;
- keep pressed the button for more than 4 seconds; the programming tone will be heard;
- enter the 3 digit of the **secondary user address** (code from 001 to 200) following the procedure reported on the paragraph "Entering codes or addresses";
- press the button to confirm; the acknowledge tone will be heard;
- proceed with another programming phase or exit the programming phase by hanging up the handset.

- **Internal secondary address** - By programming the secondary user address the internal secondary address 000 is

automatically encoded. To change it, please proceed as follows:

- enter the **programming mode** following the instructions described in "Enter the programming phase";
- keep pressed the button for more than 4 seconds; a tone will be heard;
- keep pressed the button for more than 4 seconds; a tone will be heard;
- keep pressed the button for more than 4 seconds; a tone will be heard;
- enter the 3 digit of the **internal secondary address** (code from 000 to 003) following the procedure reported on the paragraph "Entering codes or addresses";
- press the button to confirm; the acknowledge tone will be heard;
- proceed with another programming or exit the programming phase by hanging up the handset.

### Programming address to be stored to button

To this button can be stored the addresses of maximum 4 external stations which can be connected sequentially. In this way the user can monitor, communicate or open the door of 4 different external stations without being called from them but simply pressing several times the button . **In the case of a system with only 1 external door station it isn't necessary to store any address because it will be acquired automatically at the first call.**

To make the programming it necessary to:

- enter the **programming mode** following the instructions described in "Enter the programming mode";
- keep pressed the button for more than 4 seconds; a tone will be heard;
- enter the 3 digit of the **address of the 1st external door station** to be stored (code from 231 to 250) following the procedure reported on the paragraph "Entering codes or addresses";
- press the button to confirm; the acknowledge tone will be heard;
- to enter the address of the **2nd door station**, press twice the button (each pressure should last about 4 seconds); at each pressure you will hear a confirmation tone;
- enter the 3 digit of the **address of the 2nd door station** to be stored (code from 231 to 250) following the procedure reported on the paragraph "Entering codes or addresses";
- press the button to confirm; the acknowledge tone will be heard;
- if present, and you wish to enter the address of the **3rd door station**, press three times the button (each pressure should last about 4 seconds); at each pressure you will hear a confirmation tone;
- enter the 3 digit of the **address of the 3rd door station** to be stored (code from 231 to 250) following the procedure reported on the paragraph "Entering codes or addresses";
- press the button to confirm; the acknowledge tone will be heard;
- if present, and you wish to enter the address of the **4th door station**, press four times the

“” button (each pressure should last about 4 seconds); at each pressure you will hear a confirmation tone;

- enter the 3 digit of the **address of the 4th door station** to be stored (code from 231 to 250) following the procedure reported on the paragraph **“Entering codes or addresses”**;
- press the button to confirm; the acknowledge tone will be heard;
- proceed with another programming or exit the programming phase by hanging up the handset.

**Note.** Store only the addresses of the external door stations to which the user can be connected. **Don't store the addresses of external door stations belonging to different buildings even if in the same installation.**

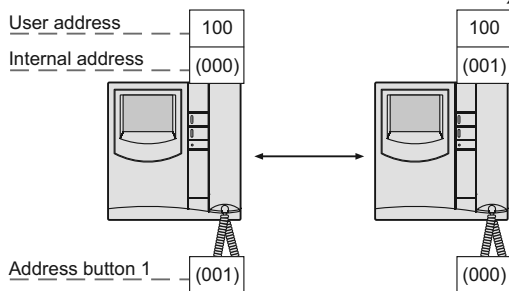
### Programming address to be stored to button "1"

This button can be used to:

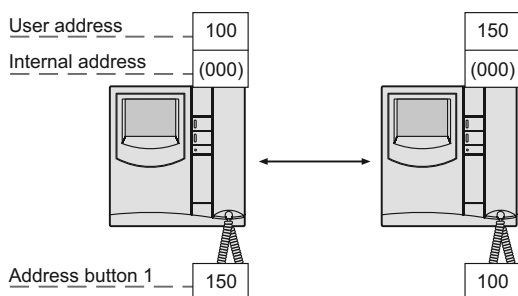
- **Intercom call** between videointercoms located in the **same apartment** (having the **same user address**); please refer to the example “a” on this page. This function requires programming the buttons with the **internal address** of the device to be called (code from **000 to 003**) following the programming procedure “1”.
- **Intercom call between users** (with **different user address**); please refer to the example “b” on next page. This function requires programming the button with the **address of the user** to be called (code from **001 to 200**) following the programming procedure “2”.
- **Monitoring external door stations**; to enable this service it is necessary to program the button with the address of the external door station (code from **231 to 250**). Follow the programming procedure “2”.

### Programming examples

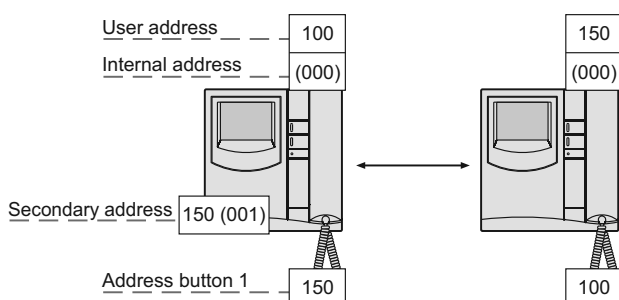
**a) 2 videointercoms in the same apartment (user address: 100; between brackets the internal addresses: 000 and 001)**



**b) 2 intercommunicating users (users address: 100 and 150)**



**c) 2 intercommunicating users, the first receiving the call addressed to the second user (users address: 100 and 150; between brackets the internal addresses: 000 and 001)**



- **Optional functions operated by means of the actuators art.2281**; to enable this service it is necessary to program the button with the address of the actuator to be operated (code from **211 to 220**). Follow the programming procedure “2”.

### Procedure 1. Button for intercom call in the same apartment

For this function only the internal address must be stored, as the user address is the same set during the user address programming on the wall bracket WB3252

To program the **internal user address** it is necessary to:

- **enter the programming mode** following the instructions described in **“Enter the programming phase”**;
- keep pressed the button **“1”** for more than 4 seconds; a tone will be heard;
- keep pressed the button for more than 4 seconds; a tone will be heard;
- enter the 3 digits that make up the internal user address of the videointercom to be called (code from **000 to 003**) following the procedure reported on the paragraph **“Entering codes or addresses”**;
- press the button to confirm; an acknowledge tone will be heard;
- exit the programming mode by hanging up the handset.

### Procedure 2. Button for calling other user, external station or activating actuators

**Note.** Intercom conversations or connections with users and external stations belonging to other buildings will not be possible if digital exchanger art.2273 is installed.

For this function only the user address must be stored as the internal user address is irrelevant.

To program the **user address** to call it is necessary to:

- **enter the programming mode** following the instructions described in **“Enter the programming phase”**;
- keep pressed the button **“1”** for more than 4 seconds; a tone will be heard;
- enter the 3 digits that make up the user address, the door station or the actuator to enable (code from **001 to 250**) following the procedure reported on the paragraph **“Entering codes or addresses”**;
- press the button to confirm; an acknowledge tone will be heard;
- exit the programming mode by hanging up the handset.

### Programming the function to assign to terminal A1

The following programming procedure enables to select a supplementary function, besides ringing, the videointercom will activate when arriving a floor call.

To program, you must:

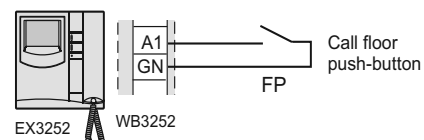
- **enter the programming mode** following the instructions described in **“Enter the programming phase”**;
- keep pressed the button for more than 4 seconds; a tone will be heard;
- keep pressed the button **“1”** for more than 4 seconds; a tone will be heard;
- enter the 3 digits that make up the **code of the desired supplementary function** (see table 2.6) following the procedure reported on the paragraph **“Entering codes or addresses”**;


**Table 2.6. Configuration of supplementary function for floor call service**

Address	Forwarding function	To devices having:
000	forwarding floor call	the same user address
001÷200	forwarding floor call	other user address
211÷220	sending actuation command	same programmed address
231÷254	send. door opening command	same programmed address
255	no supplementary function	-

### Call floor

To have the floor call connect the apparatus as illustrated in the diagram.



- press the button  to confirm; an acknowledge tone will be heard;
- proceed with another programming or exit the programming phase by hanging up the handset.

### Resetting the default values

To reset the videointercom default values and delete all the change made during programming you must:

- enter the programming mode following the instructions described in **“Enter the programming phase”**;
- enter the 3 digit **123** following the procedure reported on the paragraph **“Entering codes or addresses”**; a tone indicates that the default values have been restored;
- exit the programming phase by hanging up the handset.

### Choosing the melody for incoming calls




The videointercom can receive 4 different calls whose melodies can be changed as indicated in the procedure below. The default melodies and the call timing are shown in table 2.7.

**All programming operations must be carried out with the handset on hook.**





**Table 2.7.**  
**Factory setting for calls**

Calls	Melody	
	Timing	Type
from door station	1	Din-Don
intercommunicating	4	Dring 1
from other users	4	Dring 2
floor (local)	1	Dring 3




### Call from external door station

- Keep pressed the button  for more than 4 seconds; you hear the melodies that was programmed for calls from external door station.
- Press the button  repeatedly to select the desired melody.
- Press the button  to confirm; an acknowledge tone will be heard.



### Intercommunicating call

- Keep pressed the button  for more than 4 seconds; you hear the melody of calls from external door station.
- Keep pressed the button  for more than 4 seconds; you hear the melody that was programmed for intercommunicating calls.
- Press the button  repeatedly to select the desired melody.
- Press the button  to confirm; an acknowledge tone will be heard.





### Call from other user

- Keep pressed the button  for more than 4 seconds; you hear the melody of calls from external door station.
- Keep pressed the button  for more than 4 seconds; you hear the melody of intercommunicating calls.
- Keep pressed the button  for more than 4 seconds; you hear the melody that was pro-

grammed for calls from other user.





- Press the button  repeatedly to select the desired melody.
- Press the button  to confirm; an acknowledge tone will be heard.

### Floor (local) call

- Keep pressed the button  for more than 4 seconds; you hear the melody of calls from external door station.
- Keep pressed the button  for more than 4 seconds; you hear the melody of intercommunicating calls.
- Keep pressed the button **“1”** for more than 4 seconds; you hear the melody that was programmed for floor call.
- Press the button  repeatedly to select the desired melody.
- Press the button  to confirm; the acknowledge tone will be heard.




### Timing of ringers

By default, all the videointercom calls last for 4 rings, with the only exception of the floor call consisting of only one ring that cannot be changed. The number of rings can be varied by leaving the **handset on hook** and proceeding as follows:

- Keep pressed the button  for more than 4 seconds; you hear the melody of calls from external door station.
- Press the button  for 4 seconds, it will be possible to listen to a number of beeps corresponding to the rings programmed.
- Repeatedly press the  button to select the desired number of rings. Each pressure increases the ringing time by one ring. After 8 rings it again starts from 1.
- Press the button  to confirm; an acknowledge tone will be heard.



### Adjusting the volume of the ring tone



With the handset on hook, you can adjust 5 volume levels for all ringing tones, as indicated below:

- Keep pressed the button  for more than 4 seconds; you hear the melody of calls from external door station.
- Press the button **“1”** for 4 seconds, again it will be possible to listen to the melody of call from external station.
- Press several times the  button. Each pressure increases the volume level of the ringer. When the maximum level is reached the device is reset to the minimum.
- Press the button  to confirm; an acknowledge tone will be heard.



## OPERATION

### Call from external station.


When a call is made from the external station, the videointercom turns ON, generates the calling melody and stays ON for about 30 seconds. If the call time has expired and the videointercom has turned OFF, press the button  to reconnect with the calling external station. Pick up the handset to start conversation with the external station for about 90 seconds and press button  to open the door.

In case of a call to a user with more than one videointercom in parallel installed in the apartment, all the videointercom will ring, but only the videointercom with internal user address 000 will turn ON. You can answer also from this videointercom by following the instructions above. You can answer from the other videointercom by picking up the handset. This operation will automatically turn ON this videointercom and will turn OFF the videointercom that had been turned ON before. Press button  if you want to get the image before answering and then pick up the handset. Press and hold the  button for more than 4 seconds to switch ON the possible additional camera connected to the external door station.

### Monitor function and connection with one or more external stations.

With the system in stand-by and no conversation in progress, it would be possible to monitor the external door stations by picking up the handset and pressing the button  or the button **“1”** previously programmed for this function. If the installation includes more external stations and button  is programmed correctly, you can monitor the external stations (max. 4) in sequence by pressing the same button again and again.

The videointercom will be turned ON for about 30 seconds. The monitoring will be interrupted in case of request of monitor from another user, call between users or from an external station. If you pick up the handset during the monitoring, you will automatically establish a conversation with the external station.

If the videointercom will not turn ON when you press button , this means the installation is busy and you will have to wait until it becomes free again.

### Making or receiving a call from another user.

When the installation is in stand-by, you can make a call to another user. You must have stored the address of the desired user's in the button **“1”**.

To make the call, pick up the handset, wait for the free tone and press button **“1”**. You will hear the call tone and the videointercom of the called user will ring (without turning ON) with a melody different from calls from external stations or intercom calls from the same apartment. If the called user answers within 30 seconds, a 90-second conversation starts, otherwise the system goes back to free.

# INTERNAL STATIONS

The internal conversation in progress will be automatically interrupted in case of call from external station to any other user. If you pick up the handset and receive no tone, the installation is busy and you must wait until it is free.

## Making or receiving an intercom call in your apartment.

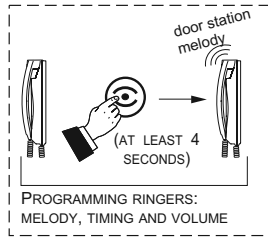
When the system is in stand-by it would be possible to make a local intercommunicating

call to all the videointercoms installed in the apartment (max 4 monitors with internal user address from 000 to 003) by pressing button "1" previously programmed with proper internal user address.

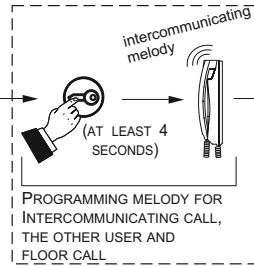
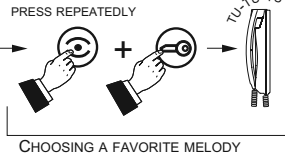
To make the intercom call, pick up the handset, wait for the free tone and press the button "1". After pressing the button you will get a calling tone on the handset, while the videointercom of the called user rings (without switching-ON) with the programmed melody.

If the called user answers within 30 seconds, a 90-second conversation starts, otherwise the system goes back to free. The internal conversation in progress will be automatically interrupted in case of call from external station to any other user.

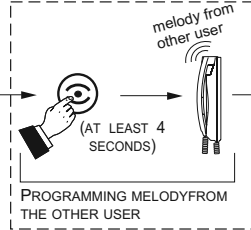
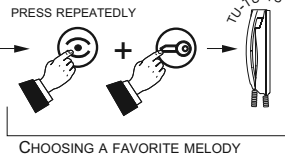
## Adjustments of the videointercom ringers



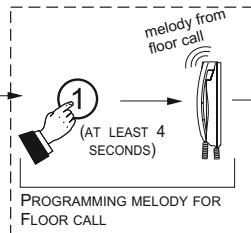
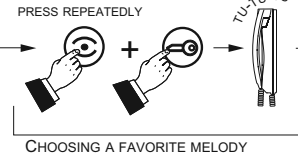
### MELODY FROM DOOR STATION CALL



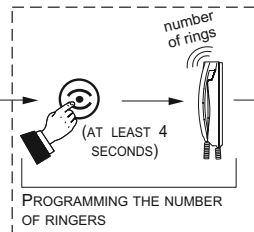
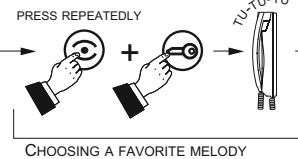
### MELODY INTERCOMMUNICATING CALL



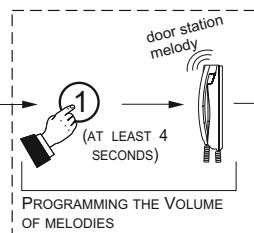
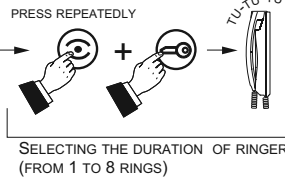
### MELODY FROM ANOTHER USER



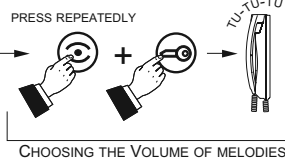
### MELODY FLOOR CALL



### NUMBER OF RINGERS



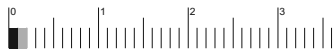
### VOLUME OF MELODIES



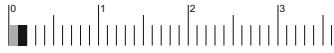
END OF PROGRAMMING

## Tone table

### Tone of pressure of a button.



### Monitor function.



### Tone.



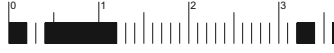
### Programming.



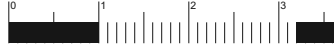
### Acknowledge tone.



### Tone of system ready.



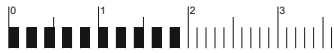
### Calling.



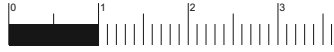
### Busy.



### Dissuasion.



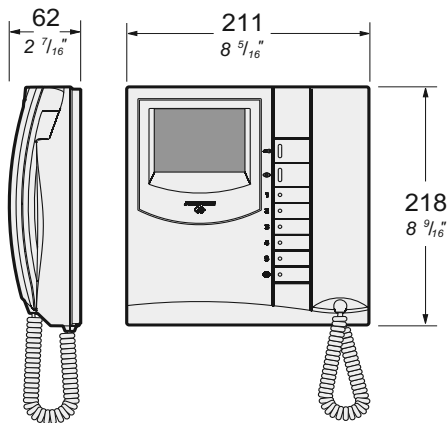
### End conversation.



**Note.** All the acoustic signalling, with the exception of the system ready and calling tone, last after about 2 seconds.



VIDEOINTERCOMS

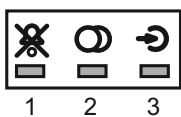


**EX3262C.** Colour videointercom with 4" LCD, private audio-video function, electronic microphone, differentiated double electronic ringing sounds (modulated and continuous) and terminal board for the connection to the wall bracket. Equipped with 3 led's and 3 buttons for camera control switch ON, door-open and various services. The videointercom can be fixed to the wall (flush-mounted) with the **WB3262** bracket or on the table with the **TA3160** adaptor.

**Technical characteristics**

Power supply directly from the line  
 Stand-by current: 8mA  
 Operating current: 0.4A  
 Screen: 4" LCD  
 Television standard: PAL  
 Band width: >5MHz  
 Starting up time: 1 second  
 Operating temperature: 0° ÷ +50°C  
 Maximum admissible humidity: 90%RH

**Signalling LEDs**

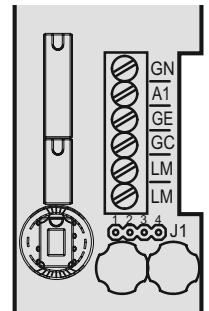


1. **Red LED.** Ringer OFF. See note (2) table 2.9.
2. **Green LED.** Conversation in progress
3. **Yellow LED.** Indicates the status of services of the actuators

**WB3262.** Wall bracket for **EX3262C** video intercoms with terminal boards for connection to the system.

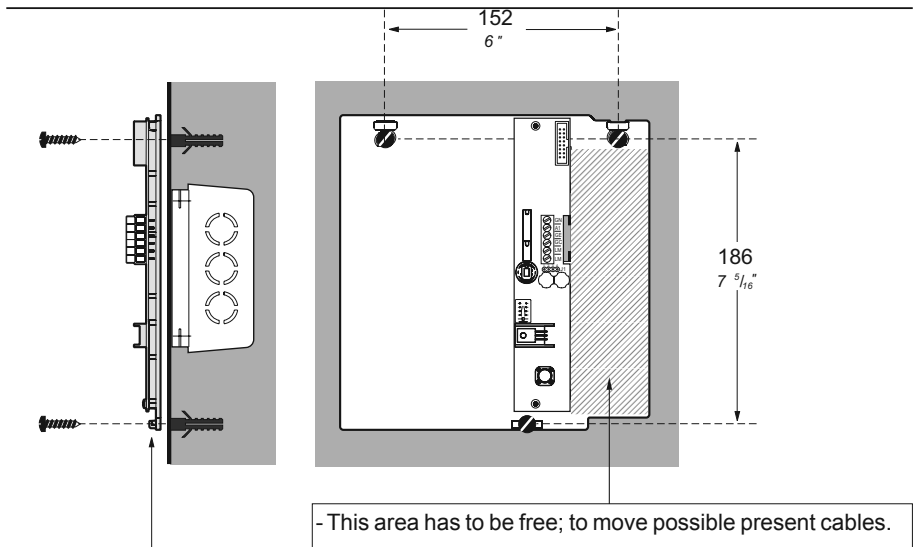
**Terminals**

- LM/LM** Line inputs
- A1** Floor call positive input
- GN** Floor call negative input
- GC** Additional actuator positive output
- GE** Additional actuator negative output

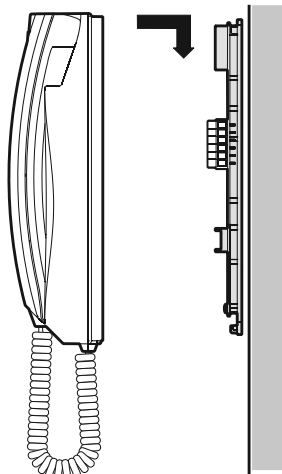


**INSTALLATION**

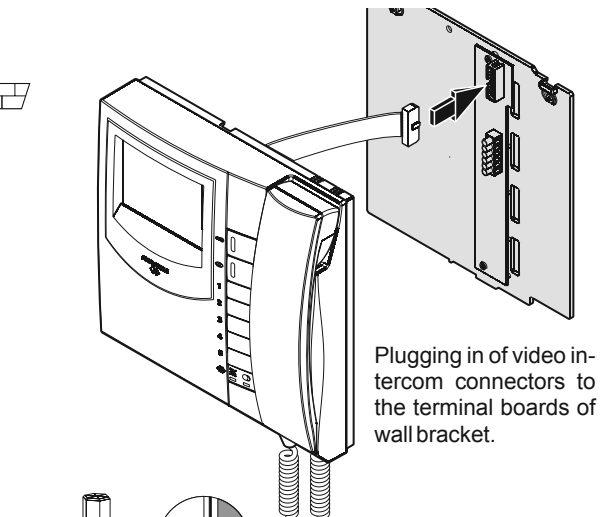
**Flush mounted version**



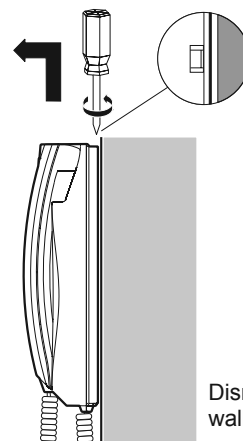
Fix the bracket to the wall with 3 screws. Don't shut the 3 screws of fixing if the wall is irregular. It is suggested to use a wall box to contain the extra wires.



Installation of video intercom onto the wall bracket.



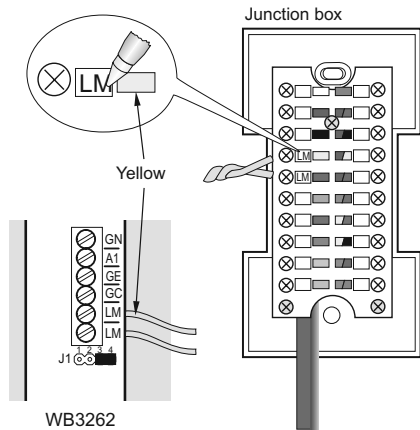
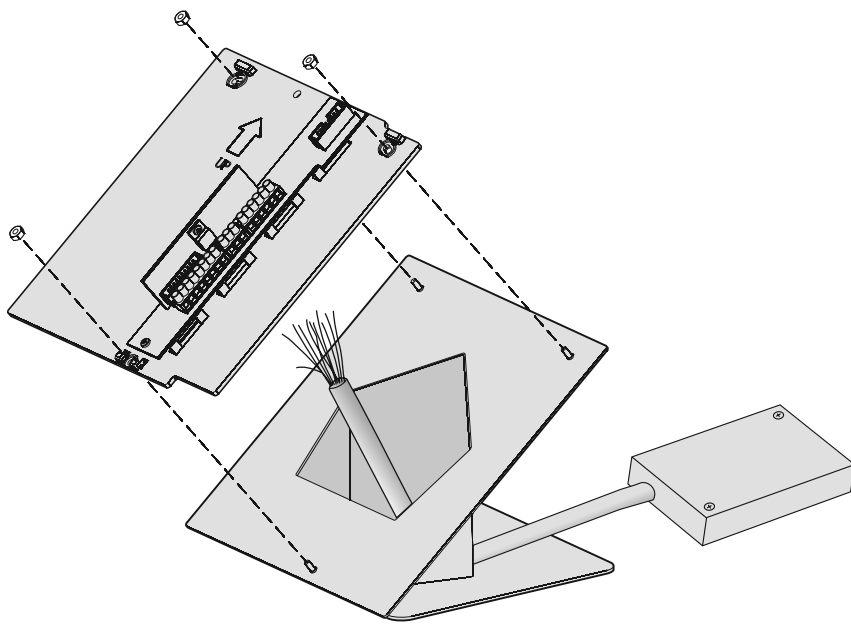
Plugging in of video intercom connectors to the terminal boards of wall bracket.



Dismounting of videointercom from the wall bracket.

## Table version

**TA3160. Table adapter** complete with junction box and 2.4m connection cable with 20 wires.

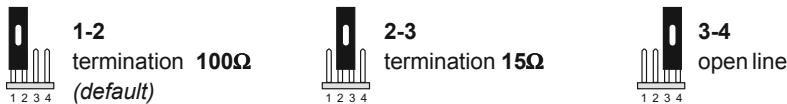


- Remove the cover to the junction box.
- Make the connection on the video intercom terminal boards and write down the correspondence between terminals and wire's colour on the label on the junction box.
- Connect the wires of the system to the terminals of the junction box.
- Fix the videointercom.

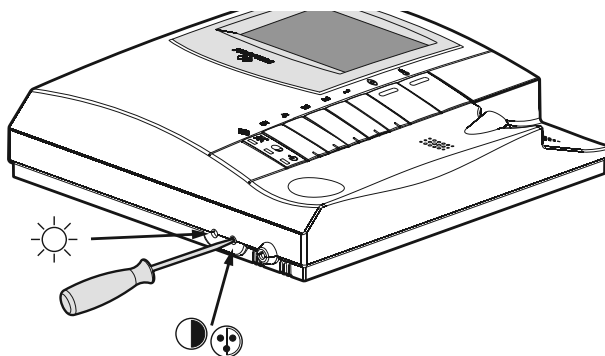
### Selecting the closing impedance

The wall bracket **WB3262** are provided with the jumper **J1** that, when placed in the correct position, allows to readapt the signal from the riser for the correct operation of the connected devices.

#### J1 Jumper to select impedance video signal



### Adjusting brightness and contrast (or color)



## PROGRAMMING

The videointercom must be suitably programmed for operation.

Two programming modes are available:

- **automatic** (quick programming of user code acting from external station);
- **manual** (programming of all videointercom functions)

The following programming is possible:

- **user address**;
- **internal address**;
- **address to assign to button** "☺"; maximum 4 addresses of external door stations;
- **code to assign to buttons** "1", "2", "3", "4", and "5" to make intercom calls, door station monitoring or for special services;
- **selection of the call timing and call melody** for 4 different call melodies (see table 2.8).

#### Factory setting

- **user address** = 100
- **internal address** = 000
- **buttons** "☺", "1", "2", "3", "4", "5" = no codes are stored to the buttons
- **number of call rings and call melody** (see table 2.8)

**Table 2.8.**  
Factory setting for calls

Calls	Melody	
	Timing	Type
from door station	1	Din-Don
intercommunicating	4	Dring 1
from other users	4	Dring 2
floor (local)	1	Dring 3

**Attention:** it is **mandatory** to program the equipment **only with the user code (address)** all other programming are optional.

#### Enter the programming mode

- Hold the button ☺ pressed for more than 4 seconds and pick up the handset after the confirmation tone; the yellow LED turns on and stays on for the entire programming selection phase.
- Release the button ☺.

If for 2 minutes no keys are pressed, system switches back to the **operating mode**.

#### Exit the programming phase

You can exit the programming mode at any time by replacing the handset; yellow LED turns-OFF.

#### Automatic programming

You can use the automatic programming mode to save the videointercom address from the external station. To enter the automatic programming mode you must:

- **enter the programming mode** following the instructions described in "Enter the programming mode";
- **make a call from an external station within 2 minutes.** In case of installations with digital push-button keyboard TD2100, key in the number you want to assign to the videointercom and press "☺". In case of installations with digital encoder



CD2131+CD2138 press the button you want to assign to the user on the push-button keyboard. When the call is received, the videointercom is programmed automatically, you hear the call tone in the loudspeaker and the videointercom is turned on, showing the calling external station. Close and pick up the handset to start a conversation with the external door station and verify the correct working mode of the equipment; programming mode is signalled on the external door station by an acknowledge tone if accepted or a dissuasion tone if rejected;

- repeat programming phases for all the videointercoms connected to the system.

## Manual programming

The manual programming mode allows you to enter the user address, assign the internal address and codes to buttons from 1 to 5 and "0"

**Using the push-buttons for programming**  
Press button "☎", "0" and "1" to enter addresses or codes.

☎: Press this button to **confirm address or code programming or go to the next programming step.**

0: Press this button to **confirm the digit just dialled** and to proceed to enter next digit in the following order: hundreds, tens, units.

1: Press this button to **increase the value you want to enter.** Press the button for a number of times equal to the digit you want to enter (digit 1 = 1 time; digit 9 = 9 times; digit 0 = 10 times).

## Entering codes or addresses

- Codes and/or addresses must have three digits (hundreds, tens, units); codes and/or addresses with tens and units or units only must be completed by adding zeros. For example, address 96 will become 096 and address 5 will become 005.

- Digits must be entered individually (beginning from the hundred), by pressing the button "1" for a number of times "n", where "n" is the value of the digit you want to enter. Store the digit pressing the button "0"; a tone will confirm the acquisition of the 1<sup>st</sup> digit.

- Follow the same procedure to store the 2<sup>nd</sup> and 3<sup>rd</sup> digit.

For example, to enter code 096 you must:

- press button "1" 10 times to enter digit 0 and press the button "0"; you will get a tone on the loudspeaker;
- press button "1" 9 times to enter digit 9 and press the button "0"; you will get a tone on the loudspeaker;
- press button "1" 6 times to enter digit 6 and press the button "0"; you will get a tone on the loudspeaker.

## Programming of the user address and internal address

- **User address** – this code allows you to receive an external call, turn on the videointercom, have a conversation and open the door at the calling external station.

- **Internal address** – these codes are used to identify the videointercoms installed in the apartment (max.6). In case of one videointercom only, the internal code must be 000 (default value); if other videointercoms are present (max. other 5) you must assign to them the codes 001, 002, 003 etc. Programming these addresses all the videointercoms will ring-UP when receiving an external, intercommunicating or floor (local) call (*if programmed*).

To program the **user address** and **internal address** it is necessary to:

- enter the **programming mode** following the instructions described in "Enter the programming mode";
- keep pressed the button ☎ for more than 4 seconds; yellow LED starts flashing;
- enter the 3 digit of the **user address** following the procedure reported on the paragraph "Entering codes or addresses";
- press the button ☎ to confirm the present phase and move to the next phase which is: programming of the **internal address**; an acknowledge tone will be heard;
- enter the 3 digit of the **internal address** following the procedure reported on the paragraph "Entering codes or addresses";
- press the button ☎ to confirm; an acknowledge tone will be heard and the yellow LED lights-ON continuously;
- proceed with another programming phase or exit the programming mode by hanging up the handset.

**Note.** If one of the two above mentioned addresses is already correctly programmed and you don't want to program it again it would be possible to skip its programming by simply pressing button ☎.

## Programming address to be stored to each button

**Button "0".** To this button can be stored the addresses of maximum 4 external stations which can be connected sequentially. In this way the user can monitor, communicate or open the door of 4 different external stations without being called from them but simply pressing several times the button 0. **In the case of a system with only 1 external door station it isn't necessary to store any address because it will be acquired automatically at the first call.**

To make the programming it necessary to:

- enter the **programming mode** following the instructions described in "Enter the programming mode";
- keep pressed the button "0" for more than 4 seconds; yellow LED starts flashing;
- enter the 3 digit of the **address of the 1st external door station** to be stored (codes from 231 to 250) following the procedure reported on the paragraph "Entering codes or addresses";
- press the button ☎ to confirm the present address move to the 2<sup>nd</sup> one; an acknowledge tone will be heard;
- enter the 3 digit of the address of the 2<sup>nd</sup>

external door station and confirm by pressing button ☎;

- proceed entering the addresses of the 3<sup>rd</sup> and 4<sup>th</sup> external stations (if present) or exit the present programming phase pressing several times the button ☎, you will be led back to selecting programming mode;
- proceed with another programming or exit the programming mode by hanging up the handset.

**Note: store only the addresses of the external door stations to which the user can be connected. Don't store the addresses of external door stations belonging to different buildings even if in the same installation.**

## Buttons 1, 2, 3, 4 and 5.

These buttons can be used to:

- **make intercommunicating calls;**

- to call users of different apartments it is necessary to store in each button of your monitor the address of the user you wish to call pressing that button (codes from 001 to 200).

- to call other videointercoms installed in the same apartment (local intercommunicating service), it is necessary to store in the buttons 1, 2, 3, 4, 5 of each monitor always the code 000; starting from button 1 and going on until you have programmed, with the code 000, as many buttons as are the videointercoms installed in the apartment (max 6 units) you wish to call; automatically by pressing buttons 1,2,3,4,5 of one unit you will call the unit whose internal address is related to the pressed button according to table 3. For example if you press the button 3 from the videointercom whose intercommunicating address is 002 you will call the user with intercommunicating address 003.

- **monitoring external door stations** (it is suggested to use button 0 to monitor the 1<sup>st</sup> external door station) to enable this feature store the address of the external door station (codes from 231 to 250).
- **optional functions operated by means of the actuators art.2281;** to enable this functions store the address of the actuator to be operated (codes from 211 to 220).

To make the programming it is necessary:

- enter the **programming mode** following the instructions described in "Enter the programming mode";
- **a** - keep pressed for more than 4 seconds the button you wish to program; yellow LED starts flashing;
- **b** - enter the 3 digit of the code or address you wish to store following the procedure reported on the paragraph "Entering codes or addresses";
- **c** - press the button ☎; an acknowledge tone will be heard and the yellow LED lights-ON continuously;
- repeat phases **a-b-c** to program other buttons or exit the programming mode by hanging up the handset; yellow LED turns-OFF.

## Notes.

- In each button can be stored only one code or address.

- Intercom conversations or connections with users and external stations of other buildings will not be possible if digital exchanger art.2273 is installed.
- A programming example is on page 2.42.

## Programming the number of ringing call

The videointercom can receive 4 different calls that can be changed as indicated in the procedure below. The default programming values and the call sequence are shown in table 2.8. All programming operations must be carried out with the handset in idle position.

- Keep pressed the button "☺" for more than 4 seconds; the yellow LED turns ON and you hear the ring tone that was programmed for calls from external door station.
- **a** - press the button "☺" repeatedly to select the ring tone.
- **b** - press the button "☺" to confirm and go on to select the number of rings.
- **c** - press the button "☺" as many times as the desired number of rings (once = 1 ring; 4 times = 4 rings).
- **d** - press the button "☺" to confirm and go on to program the ring tone for intercom calls.
- If you want to change the other two tone rings (call from other user or floor call), you must repeat steps **a-b-c-d**.
- Pick up and close the handset for exit the programming mode; yellow LED turns-OFF.

## Adjusting the volume

With the handset in idle position, you can adjust 4 volume levels for all ring tones, as indicated below:

- press the button "☺" for 4 seconds; the yellow LED turns ON and you hear the external door station ring tone;
  - hold the button "☺" pressed and release it when you hear the desired volume;
  - pick up and close the handset for exit the programming mode; yellow LED turns-OFF.
- The volume levels are stored and will be used for the next calls.

## More programming operations for specific functions

### How to program secondary user addresses

(additional programming operation that does not depend on the programming operations of user and internal station addresses)

The following programming operation allows you to save 4 additional user addresses on the same videointercom (i.e.: exchanger function, videointercom installed in common area with multiple users, etc.).

**N.B.:** videointercom must be programmed also with the **internal common address** as specified in the following.

To make the programming it is necessary:

- **enter the programming mode** following the instructions described in "Enter the programming mode";
  - keep pressed the button "☺" for more than 4 seconds; yellow LED starts flashing;
  - again keep pressed the button "☺" for more than 4 sec.; yellow LED starts quickly flashing;
  - enter the 3 digit of the **1st user secondary address** (codes from 1 to 200) following the procedure reported on the paragraph "Entering codes or addresses";
  - press the button "☺" to confirm the present address and move to the 2nd user address; an acknowledge tone will be heard;
  - enter the 3 digit of the **2nd secondary user address** and confirm by pressing button "☺";
  - proceed entering the 3rd and 4th secondary user addresses consumer (if necessary) or to press twice the "☺" to pass to the insertion of the common internal address;
  - enter the 3 digit that compose the **common internal address** to the 4 new user addresses (codes from 000 to 007) following the procedure of the paragraph "Entering codes or addresses".
- Note:* the internal common address has to be unique and different from you address him inside eventually programmed on other

videointercoms and/or intercoms that has the same user address;

- to press "☺" to confirm and to return of choice of programming; an acknowledge tone will be heard and the yellow LED lights-ON continuously;
- pick up the handset for exit the programming mode.

*Note:* If you want to make intercom calls, you must program the call buttons with the codes of the users you want to call.

### Example

How to program three videointercoms with user addresses 101, 102 and 103; from which user 103 should receive also calls addressed to user 101 and 102; user 101 and 102 should receive only calls addressed to them.

- User 101 must be programmed only with user address 101 and internal address 000.
- User 102 must be programmed only with user address 102 and internal address 000.
- User 103 must be programmed with user address 103, internal address 000, 1<sup>st</sup> secondary address 101, 2<sup>nd</sup> secondary address 102, internal common address 001 being the internal address of videointercoms 101 and 102 already programmed to 000.

### System programming

The following programming allows you to personalise the operation mode of button "1" used to deactivate the ring tones and the GC-GE terminals and send the floor call to the systems with the same user address (internal stations in parallel). See table 2.9.

To make the programming it is necessary:

- **enter the programming mode** following the instructions described in "Enter the programming mode";
- keep pressed the button "☺" for more than 4 seconds; yellow LED starts flashing;
- **a** - keep pressed the button "☺" for more than 4 seconds; yellow LED starts quickly flashing;
- **b** - press the button "1" once to enable operating mode 0 (you hear a sharp tone); within 2 seconds press the button "1" again to disable operating mode 0 (you hear a low tone);

Table 2 - System programming codes

Operating modes		Default value	To enable press 1 time button "1"	To disable press 2 times button "1"
<b>mode 0</b>	send floor call to other internal stations in parallel (1)	disabled	enabled <input type="checkbox"/>	disabled <input type="checkbox"/>
<b>mode 1</b>	button "1" deactivates all ring tones (2)	disabled	enabled <input type="checkbox"/>	disabled <input type="checkbox"/>
<b>mode 2</b>	button "1" deactivates all ring tones and button tones (2)	disabled	enabled <input type="checkbox"/>	disabled <input type="checkbox"/>
<b>mode 3</b>	button "1" does not deactivate ring tones and button tones (2)	disabled	enabled <input type="checkbox"/>	disabled <input type="checkbox"/>
<b>mode 4</b>	reserved; disabled	disabled	-	disabled <input type="checkbox"/>
<b>mode 5</b>	the GC-GE terminals are activated upon call from external door station (3)	disabled	enabled <input type="checkbox"/>	disabled <input type="checkbox"/>
<b>mode 6</b>	the GC-GE terminals are activated upon intercom call (3)	disabled	enabled <input type="checkbox"/>	disabled <input type="checkbox"/>
<b>mode 7</b>	door open warning	disabled	enabled <input type="checkbox"/>	disabled <input type="checkbox"/>

- (1) From the internal station connected to the floor call button (terminal A1) and with operating mode 0 enabled, the floor call is also sent to the other apparatuses in parallel.
- (2) If modes 1, 2 and 3 are disabled, press the button "1" for 4 seconds, without a conversation in progress, to deactivate the external and videointercom ring tones. To reactivate the ring tones, press the button "1" again for 4 seconds; you hear the confirmation tone.
- (3) If modes 5 and 6 are disabled, the GC and GE terminals are activated to send the calls.

- **c** - press the button "☺" to confirm and go on to program the next mode;
- you must repeat steps **a**, **b** and **c** to program all operating modes in table 2.9;
- after you have completed the operation and confirmed operating mode 7 with the button "☺", press the button "☹" and replace the handset to exit the programming phase.

**Note.** Programming will not be changed if the values of all modes are not entered correctly.

### Resetting the default programming values

To reset the videointercom default programming values and delete all the variations made in the programming mode you must:

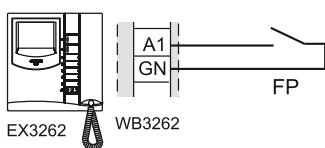
- **enter the programming mode** following the instructions described in "Enter the programming mode";
- press the buttons **5, 4, 3, 2** and **1** successively; the tone indicates that the default values have been restored.

### Additional functions

#### Call floor

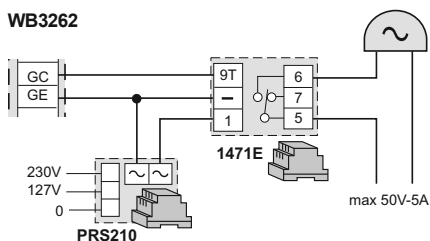
To receive a floor call you must connect a button (FP) between terminals **A1** and **GN** of the videointercom.

When the button FP is pressed, the videointercom speaker will receive a call different from calls from the external stations. The call is received also if the videointercom is in conversation.



#### Call repeater

To relaunch the call of the videointercom in other parts of the house add a relay 1471E and a transformer PRS210.



## OPERATION

### Call from external station.

When a call is made from the external station, the videointercom turns on, generates an acoustic tone and stays on for about 30 seconds. If the call time has expired and the videointercom has turned off, press the button "☺" to reconnect with the calling external station. Pick up the handset to start conversation with the external station for about 90 seconds and press button "☹" to open the door.

In case of a call to a user with more than one videointercom in parallel installed in the apartment, all the videointercom will ring, but only the videointercom with internal address 000 will turn on. You can answer from this videointercom by following the instructions above. You can answer from the other videointercom by picking up the handset. This operation will automatically turn ON this videointercom and will turn OFF the intercom that had been turned ON before. Press button "☺" if you want to see the caller before answering and then pick up the handset.

### Monitor function and connection with one or more external stations.

With the system in stand-by and no conversation in progress, it would be possible to monitor the external door stations by picking up the handset and pressing on the videointercom the button "☺" or the other buttons previously programmed for this function.

If the installation includes more external stations and button "☺" is programmed correctly, you can monitor the external stations (max. 4) in sequence by pressing the same button again and again.

The videointercom will be turned ON for about 30 seconds. The monitoring will be interrupted in case of request of monitor service by another user, call between users or from an external station.

If you pick up the handset during the monitoring, you will automatically establish a voice conversation with the external station. If the videointercom will not turned ON when you press button "☺", this means the installation is busy and you will have to wait until it becomes free again.

### Making or receiving a call from another user.

When the installation is in stand-by, you can make a call to another user. You must have stored the address of the desired user's in the numerical buttons. To make the call, pick up the handset, wait for the free tone and press button. You will hear the call tone and the videointercom of the called user will ring (without turning on) with a ring different from calls from external stations or intercom calls from the same apartment. If the called user answers within 30 seconds, a 90-second conversation starts, otherwise the system goes back to free.

The internal conversation in progress will be automatically interrupted in case of call from external station to any other user.

If you pick up the handset and receive no tone, the installation is busy and you must wait until it is free.

### Making or receiving an intercom call in your apartment.

When the system is in stand-by it would be possible to make a local intercommunicating call to all the videointercoms installed in the apartment (max 6 monitors with internal address from 000 to 005) by pressing buttons previously programmed with code 000.

To make the intercom call, pick up the handset, wait for the free tone and press proper button. After pressing the button you will get a calling tone on the loudspeaker, while the videointercom of the called user rings (without switching-ON) with the programmed melody.

If the called user answers within 30 seconds, a 90-second conversation starts, otherwise the system goes back to free.

The internal conversation in progress will be automatically interrupted in case of call from external station to any other user.

**Table 2.10. Button use for intercom calls of max. 6 videointercoms in the same apartment**

Calling video-intercoms	Videointercom to call					
	VC0	VC1	VC2	VC3	VC4	VC5
<b>VC0 (000)</b>	-	①	②	③	④	⑤
<b>VC1 (001)</b>	①	-	②	③	④	⑤
<b>VC2 (002)</b>	①	②	-	③	④	⑤
<b>VC3 (003)</b>	①	②	③	-	④	⑤
<b>VC4 (004)</b>	①	②	③	④	-	⑤
<b>VC5 (005)</b>	①	②	③	④	⑤	-

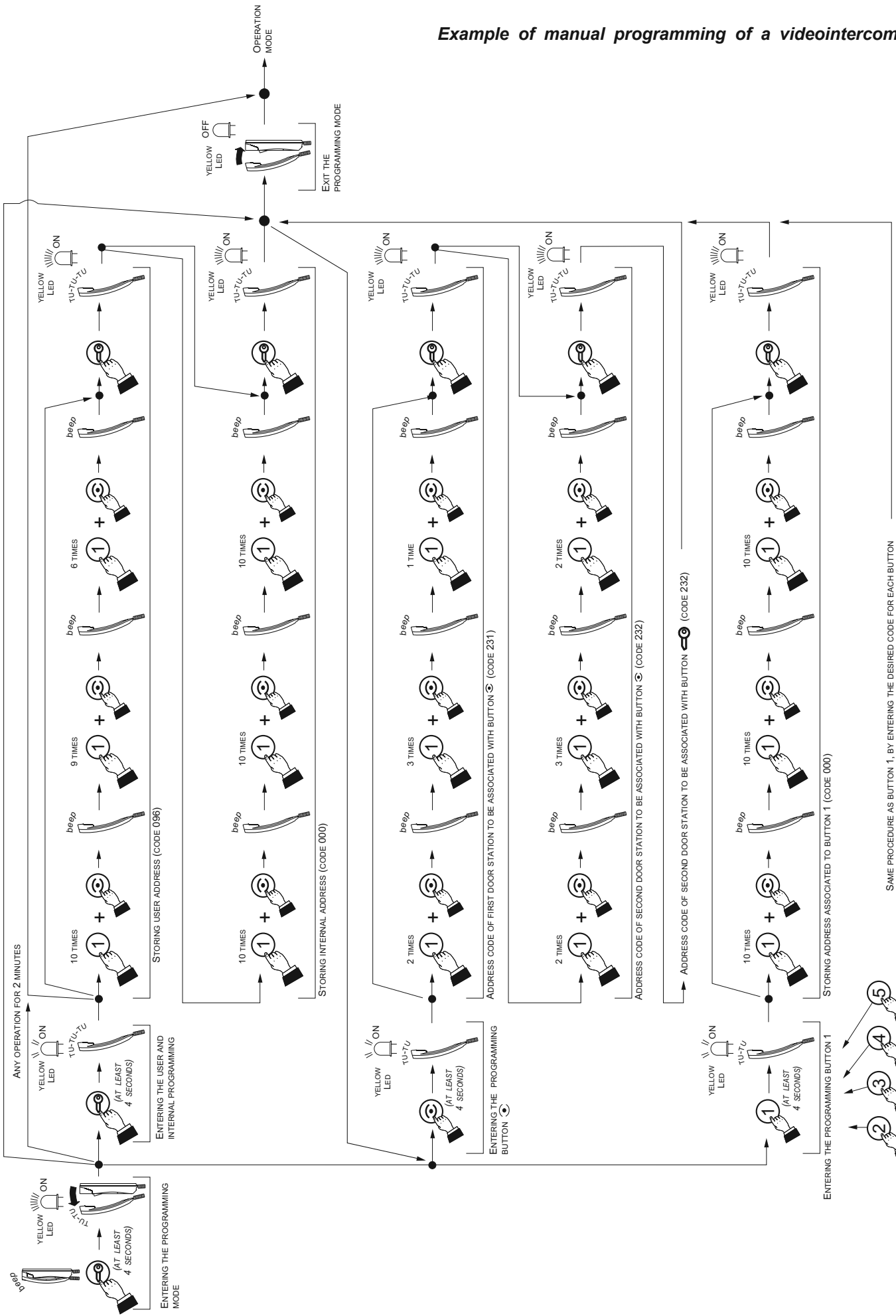
**Button to press**  
(all programmed with code 000)

**N.B.:** The codes in parenthesis in the table are the identification addresses of the internal stations that were programmed previously (see chapter "programming of the user address and internal address").

#### Examples:

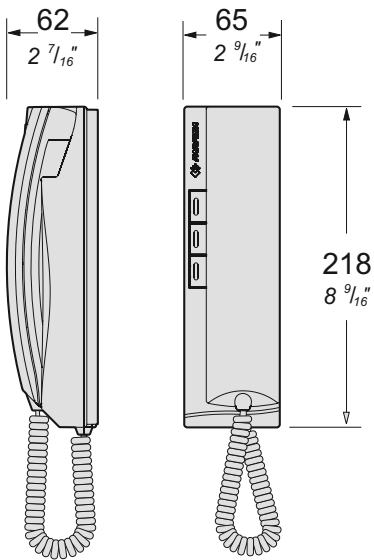
- From videointercom VC1 (internal address 001) press the button 1 for calls to videointercom VC0.
- From videointercom VC2 (internal address 002) press the button 4 for calls to videointercom VC4.
- From videointercom VC4 (internal address 004) press the button 4 for calls to videointercom VC3.





SAME PROCEDURE AS BUTTON 1, BY ENTERING THE DESIRED CODE FOR EACH BUTTON

INTERCOM



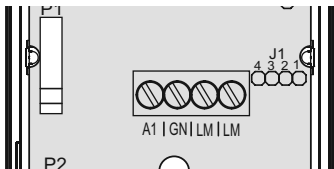
**EX352.** White colour intercom with integrated coding, 3 push-buttons, electronic microphone and spiral cord. Wall-mountable with expansion plugs or wall box or on the table with the **TA320** adaptor.

**Technical characteristics**

Power supply directly from the line  
 Stand-by current: 8mA  
 Operating current: 0.4A  
 Operating temperature: 0°++50°C  
 Maximum admissible humidity: 90%RH

**Terminals**

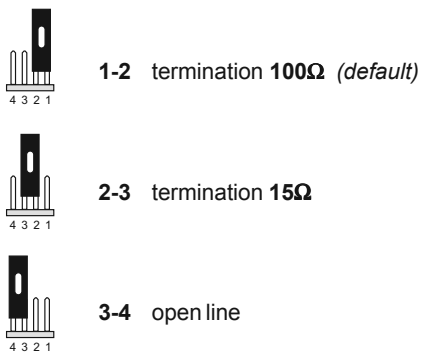
**LM/LM** Line inputs  
**A1** Floor call positive input  
**GN** Floor call negative input



**Jumper the closing impedance**

The intercom are provided with the jumper **J1** that, when placed in the correct position, allows to adapt the signal from the riser for the correct operation of the connected devices.

**J1 Jumper to select impedance termination line**



INSTALLATION

Flush mounted version

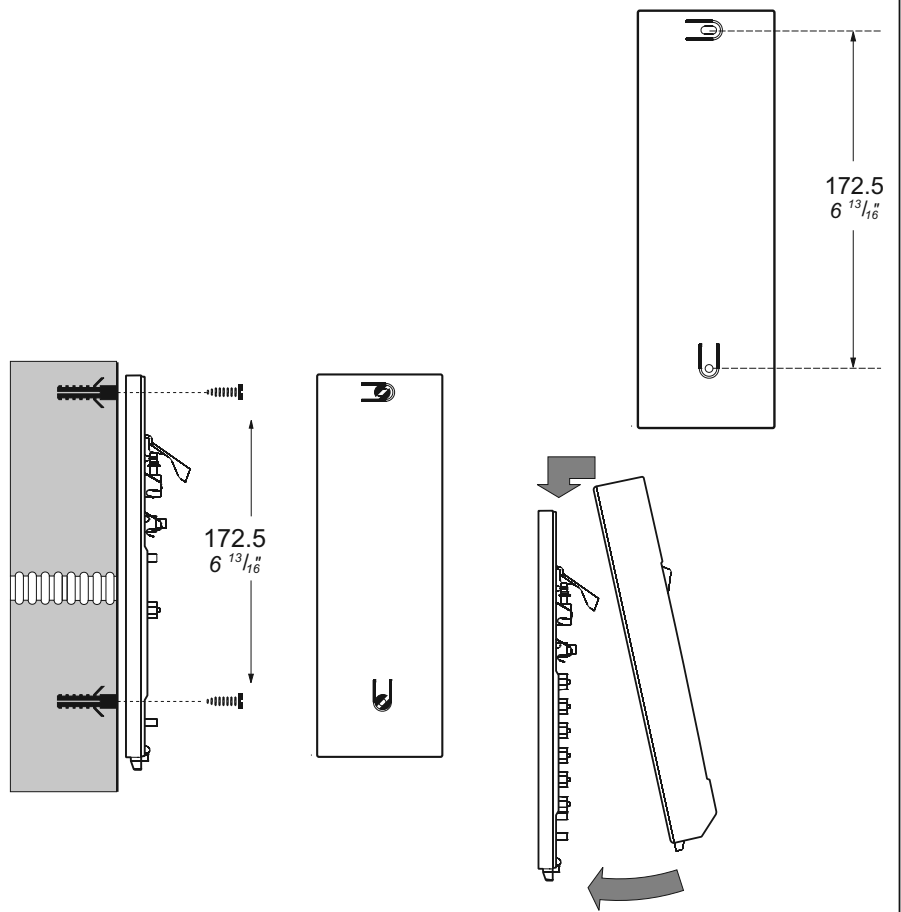
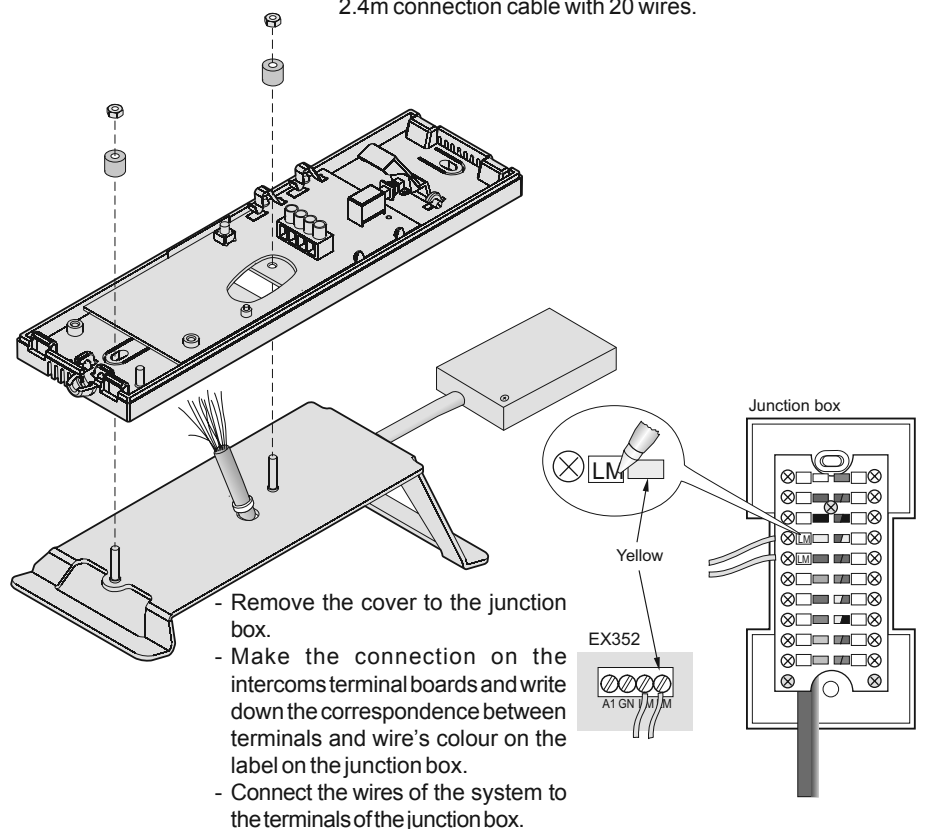


Table version

**TA320.** Table adapter complete with junction box and 2.4m connection cable with 20 wires.



- Remove the cover to the junction box.
- Make the connection on the intercoms terminal boards and write down the correspondence between terminals and wire's colour on the label on the junction box.
- Connect the wires of the system to the terminals of the junction box.

## PROGRAMMING

The intercom must be suitably programmed for operation.

Two programming modes are available:

- **automatic** (quick programming of user code acting from external station);
- **manual** (programming of all intercom functions)

The following programming is possible:

- **user address**;
- **internal address**;
- **code to assign to buttons** "□" and "◇" to make intercom calls or for special services;
- **selection of the call timing and call melody** for 4 different call melodies (see table 2.11).
- **address to be assigned to terminal A1** to transfer the floor call to other internal stations.
- **secondary address**.

**Attention:** it is mandatory to program the equipment only with the user code (address) all other programming are optional.



### Factory setting

- **User address** = 100
- **Internal address** = 000
- **Buttons** "□" and "◇" = no codes are stored to the buttons
- **Duration and type of ringer** (see table 2.11)
- **Terminal A1 address** = 255 (see table 2.12)

Table 2.11. Factory setting for calls

Calls	Melody	
	Type	Duration
from door station	Din-Don	4 rings
intercommunicating	Dring 1	
from other users	Dring 2	
floor (local)	Dring 3	1 ring

### Enter the programming phase

- Hold the button  pressed for more than 4 seconds and, after a warning beep, pick up the handset; the programming tone will be emitted.
- Release the button .


**Attention.** If for 2 minutes no keys are pressed, system switches back to the **operating mode**.

### Exit the programming phase

You can exit the programming phase at any time by replacing the handset; the acknowledge tone will be heard.

### Automatic programming


You can use the automatic programming mode to save the intercom address from the external station. To enter the automatic programming mode you must:


- **enter the programming mode** following the instructions described in "Enter the programming phase";
- **make a call from an external station within 2 minutes.** In case of installations with digital push-button keyboard TD2100, key in the number you want to assign to the intercom and press . In case of installations with digital encoder CD2131+CD2138 press the button you want to assign to the user on the push-button keyboard. When the call is received, the intercom is programmed automatically, you hear the call tone in the handset. Close and pick up the handset to start a conversation with the external door station and check the correct operation of the system; programming mode is signalled on the external door station by the acknowledge tone if accepted or a dissuasion tone if rejected;
- repeat programming phases for all the intercoms connected to the system.

### Manual programming

The manual programming mode allows you to enter the user address, assign: the internal addresses, the secondary addresses, the addresses of the buttons "□" and "◇", the address of the terminal A1 and the duration, the volume and the type of melody.

### Entering codes or addresses

Press button "◇", "□" and  to enter addresses or codes.

- ◇: Press this button to **increase the value you want to enter.** Press the button for a number of times equal to the digit you want to enter (digit 1 = 1 time; digit 9 = 9 times; digit 0 = 10 times).
- : Press this button to **confirm the digit just dialled** and to proceed to enter next digit in the following order: hundreds, tens, units.
- : Press this button to **confirm address or code programming or go to the next programming step.**

- Codes and/or addresses must have three digits (hundreds, tens, units); codes and/or addresses with tens and units or units only must be completed by adding zeros. For example, address 96 will become 096 and address 5 will become 005.
- Digits must be entered individually (beginning from the hundred), by pressing the button "◇" for a number of times "n", where "n" is the value of the digit you want to enter. Store the digit pressing the button "□"; a tone will confirm the acquisition of the 1<sup>st</sup> digit.
- Follow the same procedure to store the 2<sup>nd</sup> and 3<sup>rd</sup> digit.

For example, to enter code 096 you must:



- press button "◇" 10 times to enter digit 0 and press the button "□"; you will hear a tone;

- press button "◇" 9 times to enter digit 9 and press the button "□"; you will hear a tone;
- press button "◇" 6 times to enter digit 6 and press the button "□"; you will hear a tone.

### Programming of the user address, internal address and user secondary address

- **User address** – this code allows you to receive an external call, have a conversation and open the door at the calling external station.




To program the **user address** it is necessary to:

- **enter the programming mode** following the instructions described in "Enter the programming phase";
- keep pressed the button  for more than 4 seconds; the programming tone will be heard;
- enter the 3 digit of the **user address** (codes from 001 to 200) following the procedure reported on the paragraph "Entering codes or addresses";
- press the button  to confirm; the acknowledge tone will be heard;
- proceed with another programming phase or exit the programming phase by hanging up the handset.

- **Internal address** – these codes are used to identify the intercoms installed in the apartment (max.7). In case of one intercom only, the internal code must be 000 (default value); if other intercoms are present (max. other 6) you must assign to them the codes 001, 002, 003 etc. Programming these addresses all the intercoms will ring-UP when receiving an external, intercommunicating or floor (local) call (if programmed) but they may be called individually within the same apartment.

Each time the **user address** programming procedure is carried out, the **internal address** is automatically set to **000**. Therefore, run such a procedure only when the intercom must be assigned another and different internal address.

To program the **internal address** it is necessary to:

- **enter the programming mode** following the instructions described in "Enter the programming phase";
- keep pressed the button  for more than 4 seconds; the programming tone will be heard;
- again keep pressed the button  for more than 4 seconds; the programming tone will be heard;
- enter the 3 digit of the **internal address** (codes from 000 to 007) following the procedure reported on the paragraph "Entering codes or addresses";
- press the button  to confirm; the acknowledge tone will be heard;
- proceed with another programming phase or exit the programming phase by hanging up the handset.

# INTERNAL STATIONS

- **Secondary user address** - By storing the user address of another apartment it is possible to receive both the calls, talk to the external station and actuate the lock of the external station calling (i.e.: exchanger function, intercom installed in common area with multiple users, etc.).

To program the **secondary user address** and it is necessary to:

- enter the **programming mode** following the instructions described in "Enter the programming phase";
- keep pressed the button "☎" for more than 4 seconds; the programming tone will be heard;
- keep pressed the button "□" for more than 4 seconds; the programming tone will be heard;
- enter the 3 digit of the **secondary user address** (codes from 001 to 200) following the procedure reported on the paragraph "Entering codes or addresses";
- press the button "☎" to confirm; the acknowledge tone will be heard;
- proceed with another programming phase or exit the programming phase by hanging up the handset.

- **Internal secondary address** - By programming the secondary user address the internal address 000 is automatically encoded. To change it, please proceed as follows:

- enter the **programming mode** following the instructions described in "Enter the programming phase";
- keep pressed the button "☎" for more than 4 seconds; the programming tone will be heard;
- keep pressed the button "□" for more than 4 seconds; the programming tone will be heard;
- keep pressed the button "☎" for more than 4 seconds; the programming tone will be heard;
- enter the 3 digit of the **internal secondary address** (codes from 000 to 007) following the procedure reported on the paragraph "Entering codes or addresses";
- press the button "☎" to confirm; the acknowledge tone will be heard;
- proceed with another programming phase or exit the programming phase by hanging up the handset.

## Programming the terminal A1

The following programming procedure enables sending the function of terminal A1 (usually floor call) to other devices having the same user address user (internal stations in parallel).

To program, you must:

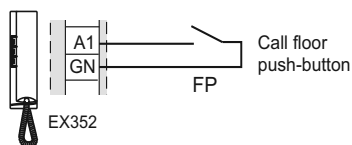
- enter the **programming mode** following the instructions described in "Enter the programming phase";
- keep pressed the button "☎" for more than 4 seconds; the programming tone will be heard;
- keep pressed the button "◇" for more than 4 seconds; the programming tone will be heard;

**Table 2.12. Addresses for the activation/deactivation of terminal A1 functions**

Address	Function transferring	To devices having:
000	call	the same user address
001÷200	call	another user address
211÷230	actuation	same programmed addressed
231÷254	door opening	same programmed addressed
255	not enable	-

## Call floor

To have the floor call connect the apparatus as illustrated in the diagram.



- enter the 3 digits that make up the **address of the desired function** (see table 2.12) following the procedure reported on the paragraph "Entering codes or addresses";
- press the button "☎" to confirm; the acknowledge tone will be heard;
- proceed with another programming phase or exit the programming phase by hanging up the handset.

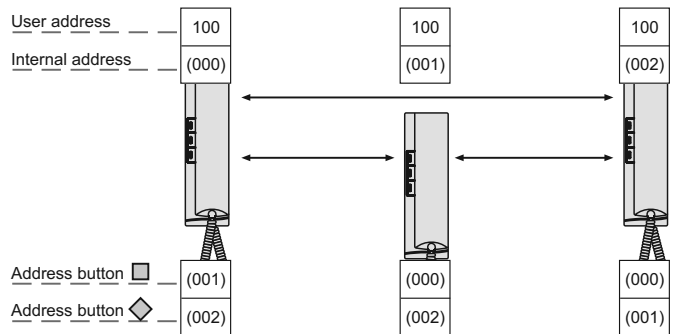
## Programming address to be stored to each button

The buttons □ and ◇ can be used to:

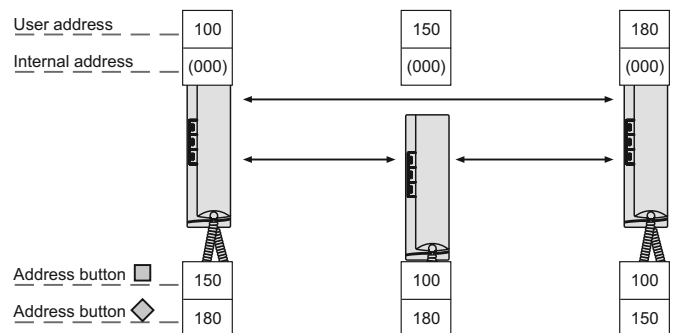
- **Intercom calls** between intercoms (or video intercoms) located in the **same apartment** (having the **same user address**), please refer to the example "a" on this page. This function requires the buttons being programmed with the **internal address** of the device to be called (codes from 000 to 007) following the programming procedure "1".
- **Intercom calls between users** (with **different user address**), please refer to the example "b" on this page. This function requires the button being programmed with the **user address** to be called (codes from 001 to 200) following the programming procedure "2"

## Programming examples

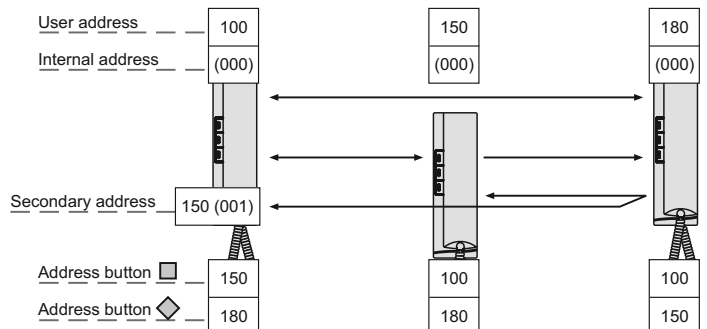
**a) 3 intercoms in an apartment (users address: 100; internal addresses in parentheses: 000, 001 and 002)**



**b) 3 intercommunicating users (users address: 100, 150 and 180)**



**c) 3 intercommunicating users, the first receiving the call addressed to the second user (users address: 100, 150 and 180; internal addresses in parentheses: 000 and 001).**





- **Direct connection to external stations;** to enable this service set the button with the address of the external station (codes from **231** to **250**). Follow the programming procedure "2"
- **Various services through actuators art.2281;** to enable this service set the button with the address of the actuator to be enabled (codes from **211** to **220**). Follow the programming procedure "2".

## 1) Function buttons for intercom calls in the same apartment

For this function only the internal address must be set, as the user address is the same set during the user address programming procedure. To program the **internal address** and it is necessary to:

- **enter the programming mode** following the instructions described in "**Enter the programming phase**";
- **a** - keep pressed for more than 4 seconds the button you wish to program; the programming tone will be heard;
- **b** - keep pressed the button "☎" for more than 4 seconds; the programming tone will be heard;
- **c** - enter the 3 digit of the address (codes from **000** to **007**) following the procedure reported on the paragraph "**Entering codes or addresses**";
- **d** - press the button ☎ to confirm; the acknowledge tone will be heard;
- repeat phases **a-b-c-d** to program other buttons or exit the programming mode by hanging up the handset; the acknowledge tone will be heard.

## 2) Function buttons for calls to other users, external stations or actuators

**Note.** *Intercom conversations or connections with users and external stations of other buildings will not be possible if digital exchanger art.2273 is installed.*

For this function only the user address must be set as the internal address is irrelevant.

To program the **user address** and it is necessary to:

- **enter the programming mode** following the instructions described in "**Enter the programming phase**";
- **a** - keep pressed for more than 4 seconds the button you wish to program; the programming tone will be heard;
- **b** - enter the 3 digit of the address (codes from **001** to **250**) following the procedure reported on the paragraph "**Entering codes or addresses**";
- **c** - press the button ☎ to confirm; the acknowledge tone will be heard;
- repeat phases **a-b-c** to program other buttons or exit the programming mode by hanging up the handset; the acknowledge tone will be heard.

## Resetting the default programming values

To reset the intercom default programming values and delete all the variations made in the programming mode you must:

- **enter the programming mode** following the instructions described in "**Enter the programming phase**";
- enter the 3 digit **123** following the procedure reported on the paragraph "**Entering codes or addresses**"; the tone indicates that the default values have been restored;
- exit the programming phase by hanging up the handset.

## Choosing the type of ringer for all calls

The intercom can receive 4 different calls that can be changed as indicated in the procedure below. The default programming values and the call sequence are shown in table 2.11.

**All programming operations must be carried out with the handset in idle position.**

## Call from external door station

- Keep pressed the button "☐" for more than 4 seconds; you hear the ring tone that was programmed for calls from external door station.
- Press the button "☐" repeatedly to select the ring tone.
- Press the button ☎ to confirm; the acknowledge tone will be heard.

## Intercommunicating call

- Keep pressed the button "☐" for more than 4 seconds; you hear the ring tone of calls from external door station.
- Keep pressed the button "☎" for more than 4 seconds; you hear the ring tone that was programmed for intercommunicating calls.
- Press the button "☐" repeatedly to select the ring tone.
- Press the button ☎ to confirm; the acknowledge tone will be heard.

## Call from other user

- Keep pressed the button "☐" for more than 4 seconds; you hear the ring tone of calls from external door station.
- Keep pressed the button "☎" for more than 4 seconds; you hear the ring tone of intercommunicating calls.
- Keep pressed the button "☐" for more than 4 seconds; you hear the ring tone that was programmed for calls from other user.
- Press the button "☐" repeatedly to select the ring tone.
- Press the button ☎ to confirm; the acknowledge tone will be heard.

## Floor (local) call

- Keep pressed the button "☐" for more than 4 seconds; you hear the ring tone of calls from external door station.
- Keep pressed the button "☎" for more than 4 seconds; you hear the ring tone of intercommunicating calls.
- Keep pressed the button "◇" for more than 4 seconds; you hear the ring tone that was programmed for floor call.
- Press the button "☐" repeatedly to select the ring tone.
- Press the button ☎ to confirm; the acknowledge tone will be heard.

## Duration of ringers

By default, all the intercom calls last for 4 rings, with the only exception of the floor call consisting of only one ring that cannot be changed. The number of rings can be varied by leaving the **receiver in its seat** and proceeding as follows:

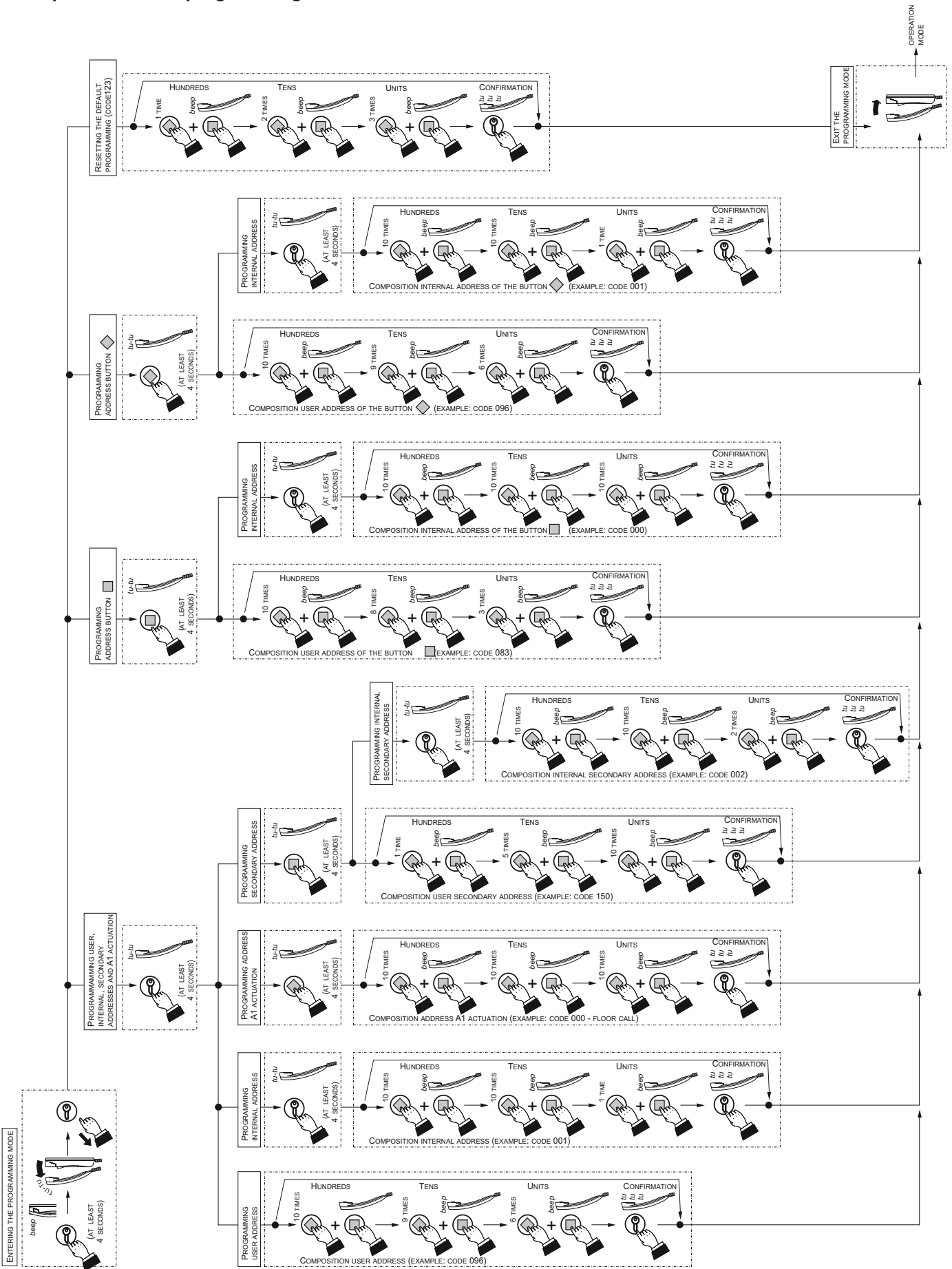
- Keep pressed the button "☐" for more than 4 seconds; you hear the ring tone of calls from external door station.
- Press the button "☐" for 4 seconds, it will be possible to listen to a number of beeps corresponding to the rings programmed.
- Repeatedly press the "☐" button to select the desired number of rings. Each pressure increases the duration of the ringing time by one ring. After 8 rings it again starts from 1.
- Press the button ☎ to confirm; the acknowledge tone will be heard.

## Adjusting the volume of the ring tone

With the handset in idle position, you can adjust 5 volume levels for all ring tones, as indicated below:

- Keep pressed the button "☐" for more than 4 seconds; you hear the ring tone of calls from external door station.
- Press the button "◇" for 4 seconds, again it will be possible to listen to the ringer of call from external station.
- Press several times the "☐" button. Each pressure increases the volume level of the ringer. When the maximum level is reached the device is reset to the minimum.
- Press the button ☎ to confirm; the acknowledge tone will be heard.

## Example of manual programming of a intercom



## OPERATION

### Call from external station.

When a call is made from the external station, the intercom generates an acoustic tone and stays ON for about 30 seconds. Pick up the handset to start conversation with the external station for about 90 seconds and press button "☎" to open the door.

### Connection with one or more external stations without receiving the call.

Picking-up the handset when the system in stand-by and no conversation in progress you will hear the tone of system ready.

By pressing the button "☎" you will be connected with the door station or, if more than one door station is present in the system, with the door station from which you received the last call; in this case if the buttons  and  have been programmed with the addresses of the door stations present in the system it would be possible to communicate with them by pressing the associated buttons. If picking up the handset is heard a busy tone, wait until the system becomes free.

### Making or receiving a call from another user.

When the installation is in stand-by, you can make a call to another user. You must have stored the address of the desired user's in the button  or .

To make the call, pick up the handset, wait for the free tone and press button. You will hear the call tone and the intercom of the called user will ring with a ring different from calls from external stations or intercom calls from the same apartment.

If the called user answers within 30 seconds, a 90-second conversation starts, otherwise the system goes back to free.

The internal conversation in progress will be automatically interrupted in case of call from external station to any other user.

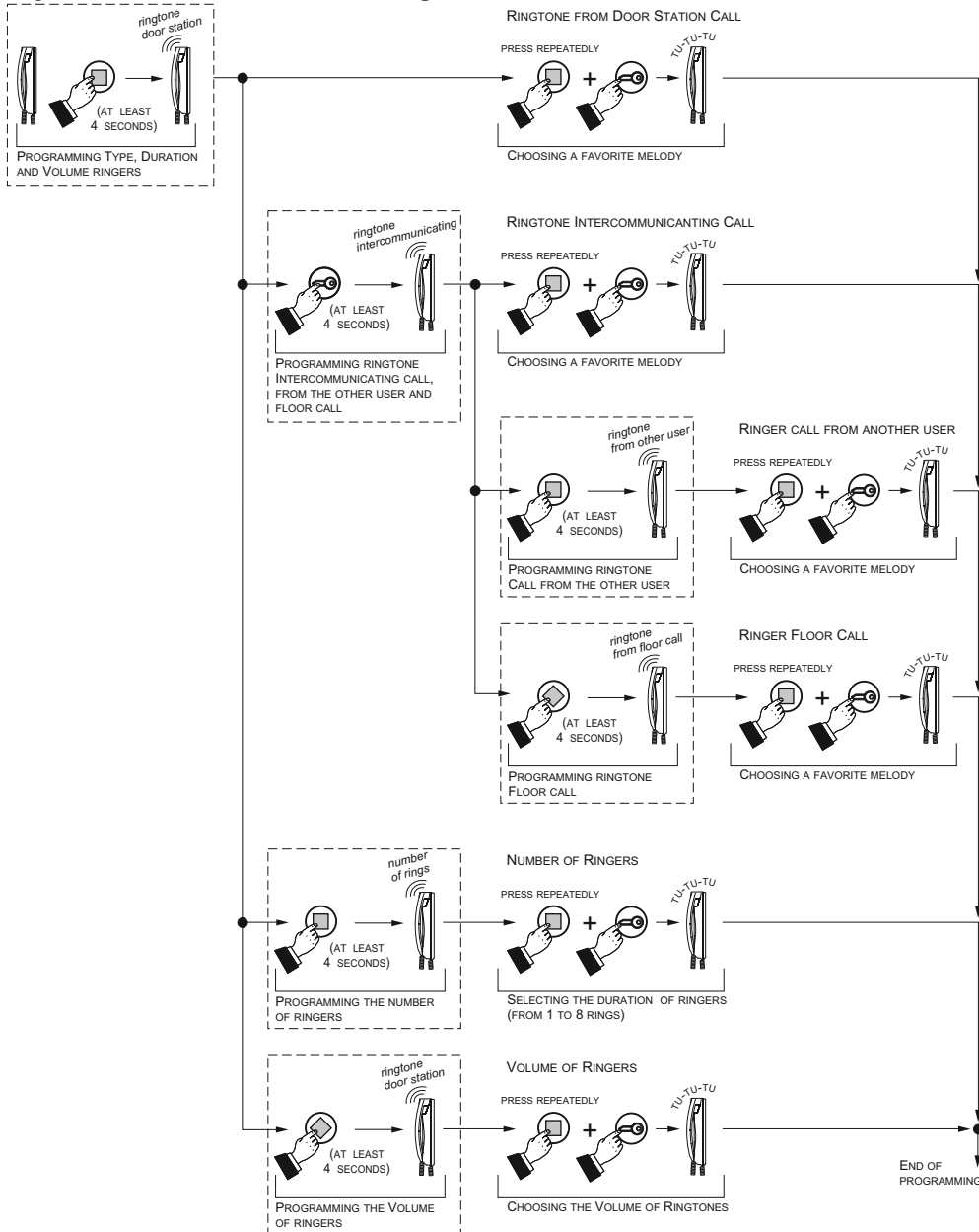
If picking up the handset is heard a busy tone, wait until the system becomes free.

### Making or receiving an intercom call in your apartment.

When the system is at rest an intercom call between two devices located in the same apartment can be made (internal codes from 000 to 007) by pressing the buttons previously programmed with the appropriate internal addresses (000, 001, etc..).

To make the intercom call, pick up the handset, wait for the free tone and press proper button. After pressing the button you will get a calling tone on the loudspeaker, while the intercom of the called user rings with the programmed melody. If the called user answers within 30 seconds, a 90-second conversation starts, otherwise the system goes back to free. The internal conversation in progress will be automatically interrupted in case of call from external station to any other user.

## Adjustments of the intercom ringers



### Tone table

#### Tone of pressure of button .



#### Tone of pressure of button .



#### Tone.



#### Programming.



#### Acknowledge tone.



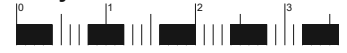
#### Tone of system ready.



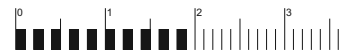
#### Calling.



#### Busy.



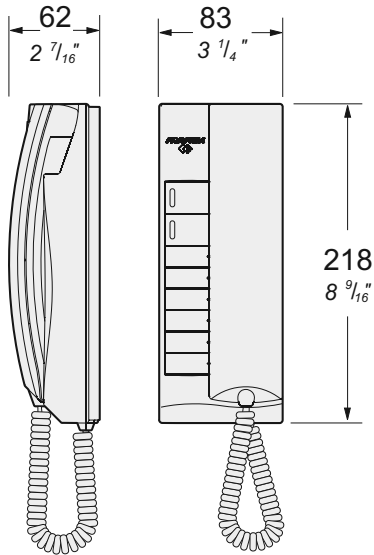
#### Dissuasion.



#### End conversation.



INTERCOM



**EX362.** White colour intercom with integrated coding, 8 push-buttons, electronic microphone and spiral cord.

Wall-mountable with expansion plugs or wall box or on the table with the **TA320** adaptor.

**Technical characteristics**

Power supply directly from the line

Stand-by current: 8mA

Operating current: 0.1A

Operating temperature: 0°+50°C

Maximum admissible humidity: 90%RH

**Terminals**

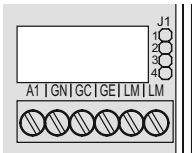
**LM/LM** Line inputs

**A1** Floor call positive input

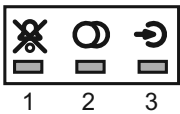
**GN** Floor call negative input

**GC** Additional actuator positive output

**GE** Additional actuator negative output



**Signalling LEDs**

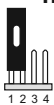


1. **Red LED.** Ringer OFF. See note (2) table 2.14.
2. **Green LED.** Conversation in progress
3. **Yellow LED.** Indicates the status of services of the actuators

**Jumper the closing impedance**

The intercom are provided with the jumper **J1** that, when placed in the correct position, allows to adapt the signal from the riser.

**J1 Jumper to select impedance termination line**



**1-2** termination **100Ω** (default)



**2-3** termination **15Ω**



**3-4** open line

INSTALLATION

Flush mounted version

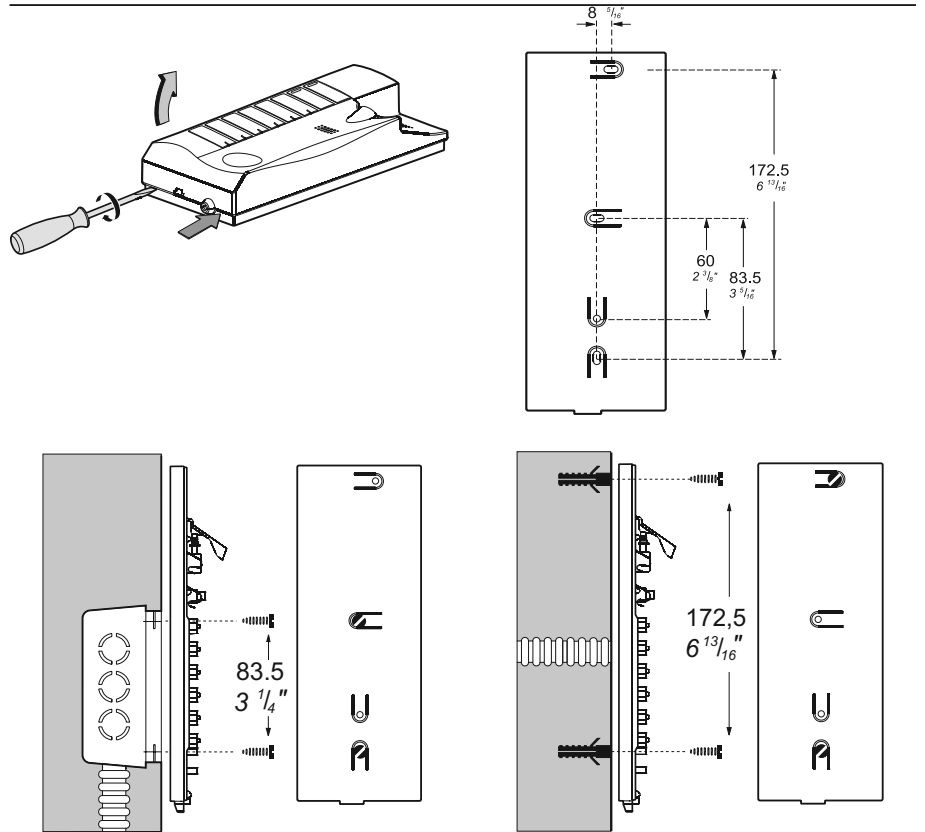
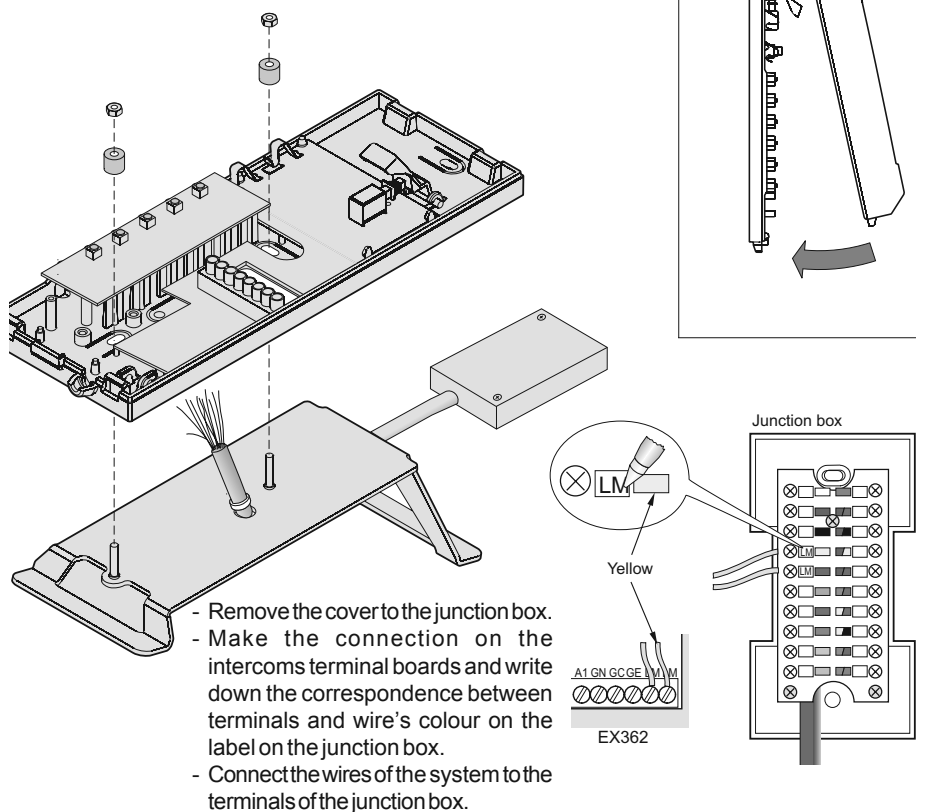


Table version

**TA320.** Table adapter complete with junction box and 2.4m connection cable with 20 wires.



- Remove the cover to the junction box.
- Make the connection on the intercoms terminal boards and write down the correspondence between terminals and wire's colour on the label on the junction box.
- Connect the wires of the system to the terminals of the junction box.

## PROGRAMMING

The intercom must be suitably programmed for operation.

Two programming modes are available:

- **automatic** (quick programming of user code acting from external station);
- **manual** (programming of all intercom functions)

The following programming is possible:

- **user address**;
- **internal address**;
- **code to assign to buttons "1", "2", "3", "4", "5" and "6"** to make intercom calls or for special services;
- **selection of the call timing and call melody** for 4 different call melodies (see table 2.13).

### Factory setting


- **user address** = 100
- **internal address** = 000
- **buttons "1", "2", "3", "4", "5", "6"** = no codes are stored to the buttons
- **number of call rings and call melody** (see table 2.13)


Table 2.13. Factory setting for calls

Calls	Melody	
	Type	Duration
from door station	1	Din-Don
intercommunicating	4	Dring 1
from other users	4	Dring 2
floor (local)	1	Dring 3

**Attention:** it is **mandatory** to program the equipment only with the **user code** (address) all other programming are optional.

### Enter the programming phase

- Hold the button  pressed for more than 4 seconds and pick up the handset after the confirmation tone; the yellow LED turns on and stays on for the entire programming selection phase.

- Release the button .


If for 2 minutes no keys are pressed, system switches back to the **operating mode**.

### Exit the programming phase

You can exit the programming phase at any time by replacing the handset; yellow LED turns-OFF.

### Automatic programming

You can use the automatic programming mode to save the intercom address from the external station. To enter the automatic programming mode you must:

- **enter the programming mode** following the instructions described in "Enter the programming phase";
- **make a call from an external station within 2 minutes**. In case of installations with digital push-button keyboard TD2100, key in the number you want to assign to the intercom and press . In case of installations with digital encoder CD2131÷CD2138 press the button


you want to assign to the user on the push-button keyboard. When the call is received, the intercom is programmed automatically, you hear the call tone in the handset. Close and pick up the handset to start a conversation with the external door station and check the correct operation of the system; programming mode is signalled on the external door station by an acknowledge tone if accepted or a dissuasion tone if rejected;


- repeat programming phases for all the intercoms connected to the system.

### Manual programming

The manual programming mode allows you to enter the user address, assign the internal address and codes to numerical buttons (from 1 to 6).

### Using the push-buttons for programming

Press button , "1" and "2" to enter addresses or codes.

: Press this button to **confirm address or code programming or go to the next programming step**.

①: Press this button to **confirm the digit just dialled** and to proceed to enter next digit in the following order: hundreds, tens, units.

②: Press this button to **increase the value you want to enter**. Press the button for a number of times equal to the digit you want to enter (digit 1 = 1 time; digit 9 = 9 times; digit 0 = 10 times).

### Entering codes or addresses

- Codes and/or addresses must have three digits (hundreds, tens, units); codes and/or addresses with tens and units or units only must be completed by adding zeros. For example, address 96 will become 096 and address 5 will become 005.

- Digits must be entered individually (beginning from the hundred), by pressing the button "2" for a number of times "n", where "n" is the value of the digit you want to enter. Store the digit pressing the button "1"; a tone will confirm the acquisition of the 1<sup>st</sup> digit.

- Follow the same procedure to store the 2nd and 3rd digit.

For example, to enter code 096 you must:




- press button "2" 10 times to enter digit 0 and press the button "1"; you will get a tone on the loudspeaker;
- press button "2" 9 times to enter digit 9 and press the button "1"; you will get a tone on the loudspeaker;
- press button "2" 6 times to enter digit 6 and press the button "1"; you will get a tone on the loudspeaker.


### Programming of the user address and internal address

- **User address** – this code allows you to receive an external call, have a conversation and open the door at the calling external station.

- **Internal address** – these codes are used to identify the intercoms installed in the apartment (max.7). In case of one intercom only, the internal code must be 000 (default value); if other intercoms are present (max. other 6) you must assign to them the codes 001, 002, 003 etc. Programming these addresses all the intercoms will ring-UP when receiving an external, intercommunicating or floor (local) call (if programmed).

To program the **user address** and **internal address** it is necessary to:

- **enter the programming mode** following the instructions described in "Enter the programming phase";
- keep pressed the button  for more than 4 seconds; yellow LED starts flashing;
- enter the 3 digit of the **user address** following the procedure reported on the paragraph "Entering codes or addresses";
- press the button  to confirm the present phase and move to the next phase which is: programming of the **internal address**; an acknowledge tone will be heard;
- enter the 3 digit of the **internal address** following the procedure reported on the paragraph "Entering codes or addresses";
- press the button  to confirm; an acknowledge tone will be heard and the yellow LED lights-ON continuously;
- proceed with another programming phase or exit the programming phase by hanging up the handset.

**Note.** If one of the two above mentioned addresses is already correctly programmed and you don't want to program it again it would be possible to skip its programming by simply pressing button .

### Programming address to be stored to each button


#### Buttons 1, 2, 3, 4, 5 and 6.

These buttons can be used to:

- **make intercommunicating calls**;
  - to call users of different apartments it is necessary to store in each button of your intercom the address of the user you wish to call pressing that button (codes from **001** to **200**).
  - to call other intercoms installed in the same apartment (local intercommunicating service), it is necessary to store in the buttons 1, 2, 3, 4, 5, 6 of each intercom always the code **000**; starting from button 1 and going on until you have programmed, with the code 000, as many buttons as are the intercoms installed in the apartment you wish to call; automatically by pressing buttons of one unit you will call the unit whose internal address is related to the pressed button according to table 2.15.
- For example if you press the button 3 from the intercom whose intercommunicating address is **002** you will call the user with intercommunicating address **003**.

- **monitoring external door stations;** to enable this feature store the address of the external door station (codes from **231** to **250**).
- **optional functions operated by means of the actuators art.2281;** to enable this functions store the address of the actuator to be operated (codes from **211** to **220**).

To make the programming it is necessary:

- **enter the programming mode** following the instructions described in "Enter the programming phase";
- **a** - keep pressed for more than 4 seconds the button you wish to program; yellow LED starts flashing;
- **b** -enter the 3 digit of the code or address you wish to store following the procedure reported on the paragraph "Entering codes or addresses";
- **c** -press the button ; an acknowledge tone will be heard and the yellow LED lights-ON continuously;
- repeat phases **a-b-c** to program other buttons or exit the programming mode by hanging up the handset; yellow LED turns-OFF.



### Notes.

- In each button can be stored only one code or address.
- Intercom conversations or connections with users and external stations of other buildings will not be possible if digital exchanger art.2273 is installed.

### Programming the number of ringing call


The intercom can receive 4 different calls that can be changed as indicated in the procedure below. The default programming values and the call sequence are shown in table 2.13.

All programming operations must be carried out with the handset in idle position.

- Keep pressed the button "1" for more than 4 seconds; the yellow LED turns ON and you hear the ring tone that was programmed for calls from external door station.
- **a** - Press the button "1" repeatedly to select the ring tone.
- **b** - Press the button  to confirm and go on to select the number of rings.
- **c** - Press the button "1" as many times as the desired number of rings (once = 1 ring; 4 times = 4 rings).
- **d** - Press the button  to confirm and go on to program the ring tone for intercom calls.
- If you want to change the other two tone rings (call from other user or floor call), you must repeat steps **a-b-c-d**.
- Pick up and close the handset for exit the programming mode; yellow LED turns-OFF.

### Adjusting the volume

With the handset in idle position, you can adjust 4 volume levels for all ring tones, as indicated below:

- press the button "1" for 4 seconds; the yellow LED turns ON and you hear the external door station ring tone;
- hold the button  pressed and release it when you hear the desired volume;
- pick up and close the handset for exit the programming mode; yellow LED turns-OFF.

The volume levels are stored and will be used for the next calls.

### More programming operations for specific functions







#### How to program secondary user addresses

(additional programming operation that does not depend on the programming operations of user and internal station addresses)

The following programming operation allows you to save 4 additional user addresses on the same intercom (i.e.: exchanger function, intercom installed in common area with multiple users, etc.).

**N.B.:** intercom must be programmed also with the internal common address as specified in the following.

To make the programming it is necessary:

- **enter the programming mode** following the instructions described in "Enter the programming phase";
  - keep pressed the button  for more than 4 seconds; yellow LED starts flashing;
  - again keep pressed the button  for more than 4 sec.; yellow LED starts quickly flashing;
  - enter the 3 digit of the **1st user secondary address** (codes from 1 to 200) following the procedure reported on the paragraph "Entering codes or addresses";
  - press the button  to confirm the present address and move to the 2nd user address; an acknowledge tone will be heard;
  - enter the 3 digit of the **2nd user secondary address** and confirm by pressing button ;
  - proceed entering the 3rd and 4th secondary user addresses consumer (if necessary) or to press twice the  to pass to the insertion of the internal common address;
  - enter the 3 digit that compose the **internal common address** to the 4 new user addresses (codes from 000 to 006) following the procedure of the paragraph "Entering codes or addresses".
- Note:* the internal common address has to be unique and different from you address him inside eventually programmed on other intercoms that has the same user address;
- to press  to confirm and to return of choice of programming; an acknowledge tone will be heard and the yellow LED lights-ON continuously;
  - pick up the handset for exit the programming mode.

*Note:* If you want to make intercom calls, you must program the call buttons with the codes of the users you want to call.

#### Example

How to program three intercoms with user addresses 101, 102 and 103; from which user 103 should receive also calls addressed to user 101 and 102; user 101 and 102 should receive only calls addressed to them.

- User 101 must be programmed only with user address 101 and internal address 000.
- User 102 must be programmed only with user



address 102 and internal address 000.

- User 103 must be programmed with user address 103, internal address 000, 1<sup>st</sup> secondary address 101, 2<sup>nd</sup> secondary address 102, internal common address 001 being the internal address of intercoms 101 and 102 already programmed to 000.

### System programming

The following programming allows you to personalise the operation mode of button "1" used to deactivate the ring tones and the GC-GE terminals and send the floor call to the systems with the same user address (internal stations in parallel). See table 2.14.

To make the programming it is necessary:

- **enter the programming mode** following the instructions described in "Enter the programming phase";
  - keep pressed the button  for more than 4 seconds; yellow LED starts flashing;
  - **a** - keep pressed the button "1" for more than 4 seconds; yellow LED starts quickly flashing;
  - **b** - press the button "2" once to enable operating mode 0 (you hear a sharp tone); within 2 seconds press the button "2" again to disable operating mode 0 (you hear a low tone);
  - **c** - press the button "1" to confirm and proceed to program the next mode;
  - you must repeat steps **a, b** and **c** to program all operating modes in table 2.14;
  - after you have completed the operation and confirmed operating mode 7 with the button "1", press the button  and replace the handset to exit the programming phase.
- Note.** Programming will not be changed if the values of all modes are not entered correctly.
- Programming example of page 2.53.

### Resetting the default programming values

To reset the intercom default programming values and delete all the variations made in the programming mode you must:

- **enter the programming mode** following the instructions described in "Enter the programming phase";
- press the buttons **6, 5, 4, 3, 2** and **1** successively; the tone indicates that the default values have been restored.

### Additional functions

See on page 2.41.

### Tone and calling tables

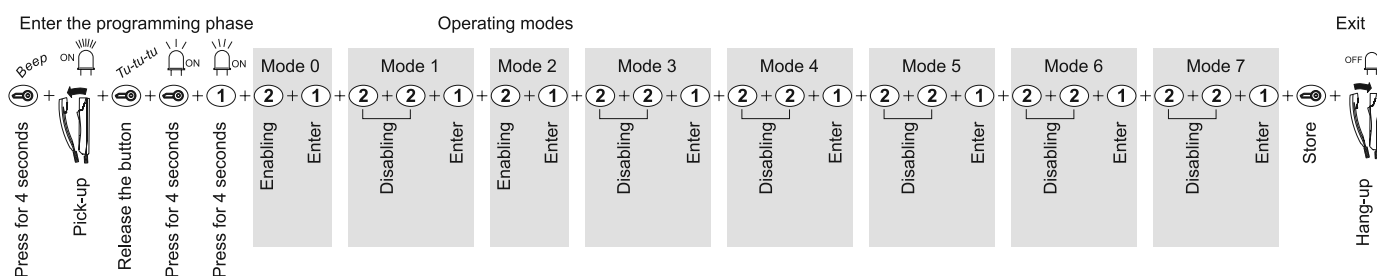
See on page 2.42.

**Table 2.14 - System programming codes**

Operating modes		Default value	To enable press 1 time button "2"	To disable press 2 times button "2"
<b>mode 0</b>	send floor call to other internal stations in parallel (1)	disabled	enabled <input type="checkbox"/>	disabled <input type="checkbox"/>
<b>mode 1</b>	button "2" deactivates all ring tones (2)	disabled	enabled <input type="checkbox"/>	disabled <input type="checkbox"/>
<b>mode 2</b>	button "2" deactivates all ring tones and button tones (2)	disabled	enabled <input type="checkbox"/>	disabled <input type="checkbox"/>
<b>mode 3</b>	button "2" does not deactivate ring tones and button tones (2)	disabled	enabled <input type="checkbox"/>	disabled <input type="checkbox"/>
<b>mode 4</b>	reserved; disabled	disabled	-	disabled <input type="checkbox"/>
<b>mode 5</b>	the GC-GE terminals are activated upon call from external door station (3)	disabled	enabled <input type="checkbox"/>	disabled <input type="checkbox"/>
<b>mode 6</b>	the GC-GE terminals are activated upon intercom call (3)	disabled	enabled <input type="checkbox"/>	disabled <input type="checkbox"/>
<b>mode 7</b>	door open warning	disabled	enabled <input type="checkbox"/>	disabled <input type="checkbox"/>

- (1) From the internal station connected to the floor call button (terminal A1) and with operating mode 0 enabled, the floor call is also sent to the other apparatuses in parallel.
- (2) If modes 1, 2 and 3 are disabled, press the button "2" for 4 seconds, without a conversation in progress, to deactivate the external and intercom ring tones. To reactivate the ring tones, press the button "2" again for 4 seconds; you hear the confirmation tone.
- (3) If modes 5 and 6 are disabled, the GC and GE terminals are activated to send the calls.

**Example of system programming to enable operating mode 0 and 2 and to disable all the others operating modes**



## OPERATION

### Call from external station.

When a call is made from the external station, the intercom generates an acoustic tone and stays ON for about 30 seconds. Pick up the handset to start conversation with the external station for about 90 seconds and press button "☎" to open the door.

### Connection with one or more external stations without receiving the call.

Picking-up the handset when the system in stand-by and no conversation in progress you will hear the tone of system ready.

By pressing the button "☎" you will be connected with the door station or, if more than one door station is present in the system, with the door station from which you received the last call; in this case if the buttons from 1 to 6 have been programmed with the addresses of the door stations present in the system it would be possible to communicate with them by pressing the associated buttons. If picking up the handset you did not get any tone, the system is busy (a communication with another user is in progress), and no other operations are allowed until the system becomes free.

### Making or receiving a call from another user.

When the installation is in stand-by, you can make a call to another user. You must have stored the address of the desired user's in the buttons 1+6. To make the call, pick up the handset, wait for the free tone and press button. You will hear the

call tone and the intercom of the called user will ring with a ring different from calls from external stations or intercom calls from the same apartment. If the called user answers within 30 seconds, a 90-second conversation starts, otherwise the system goes back to free.

The internal conversation in progress will be automatically interrupted in case of call from external station to any other user.

If you pick up the handset and receive no tone, the installation is busy and you must wait until it is free.

### Making or receiving an intercom call in your apartment.

When the installation is in stand-by, you can make an intercom call to all intercom in the same apartment (max 7 with internal address from 000 to 006) by pressing buttons previously programmed with code 000 (see table 2.15).

To make the intercom call, pick up the handset, wait for the free tone and press proper button. After pressing the button you will get a calling tone on the loudspeaker, while the intercom of the called user rings with the programmed melody. If the called user answers within 30 seconds, a 90-second conversation starts, otherwise the system goes back to free.

The internal conversation in progress will be automatically interrupted in case of call from external station to any other user.

**Table 2.15. Button use for intercom calls of max. 7 intercoms in the same apartment.**

Calling intercoms	Intercom to call						
	CT0	CT1	CT2	CT3	CT4	CT5	CT6
<b>CT0 (000)</b>	-	①	②	③	④	⑤	⑥
<b>CT1 (001)</b>	①	-	②	③	④	⑤	⑥
<b>CT2 (002)</b>	①	②	-	③	④	⑤	⑥
<b>CT3 (003)</b>	①	②	③	-	④	⑤	⑥
<b>CT4 (004)</b>	①	②	③	④	-	⑤	⑥
<b>CT5 (005)</b>	①	②	③	④	⑤	-	⑥
<b>CT6 (006)</b>	①	②	③	④	⑤	⑥	-

**Button to press**  
(all programmed with code 000)

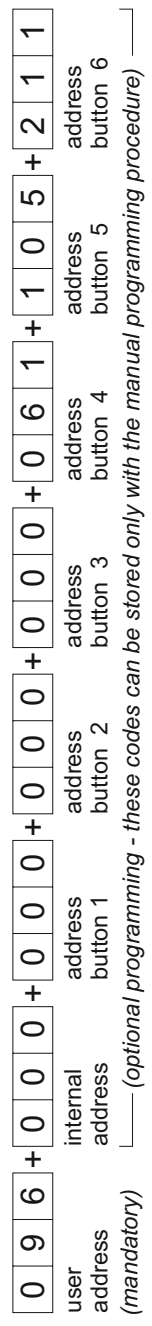
**N.B.:** The codes in parenthesis in the table are the identification addresses of the internal stations that were programmed previously (see chapter "programming of the user address and internal address").

### Examples:

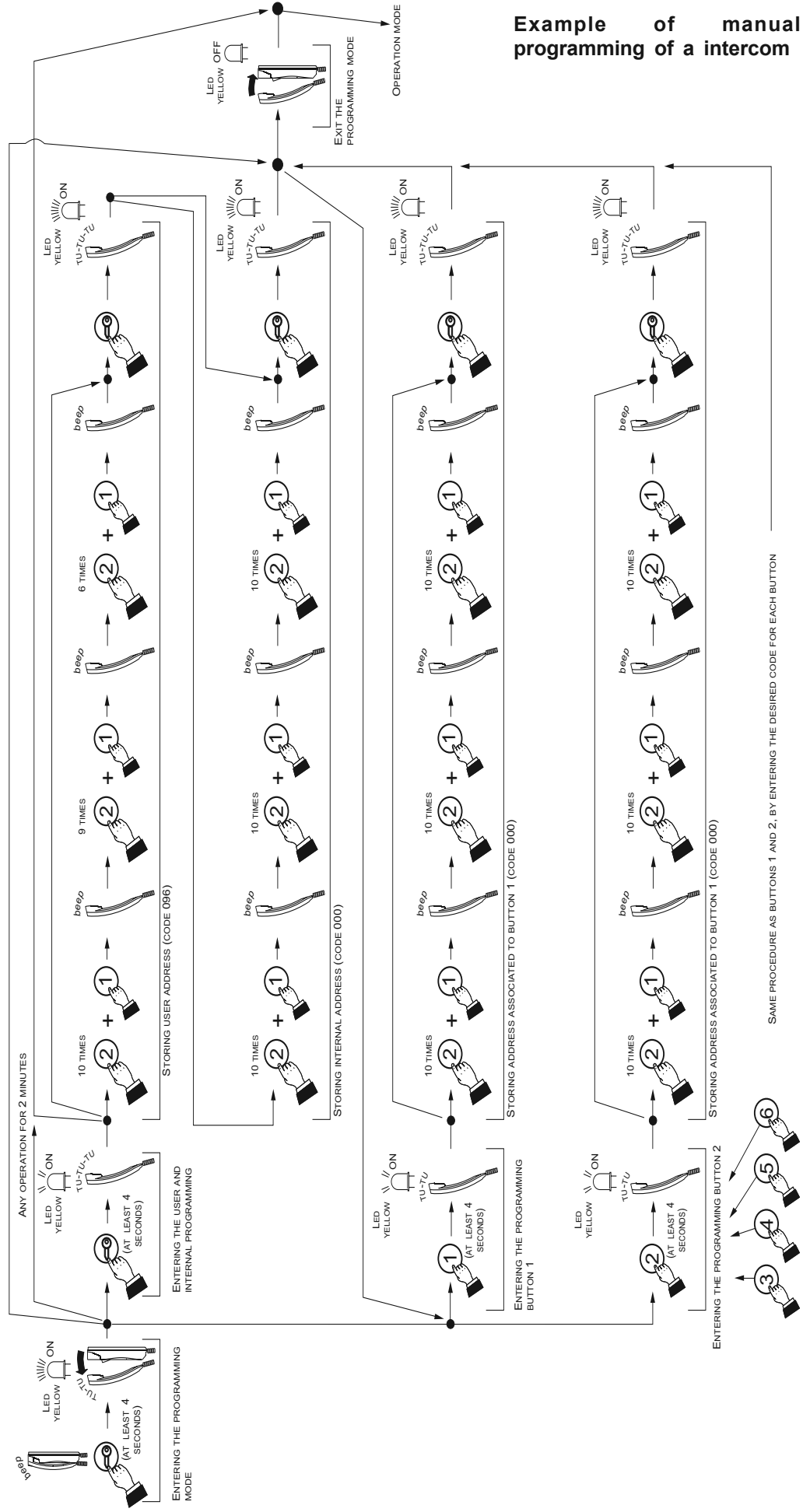
- From intercom CT1 (internal address 001) press the button 1 for calls to intercom CT0.
- From intercom CT2 (internal address 002) press the button 4 for calls to intercom CT4.
- From intercom CT4 (internal address 004) press the button 4 for calls to intercom CT3.

# INTERNAL STATIONS

**Example of manual programming of intercom connected to 4 external door stations, intercom call in own apartment with other 3 intercoms, intercom call with other 2 extensions and activation of actuator for supplementary services.**



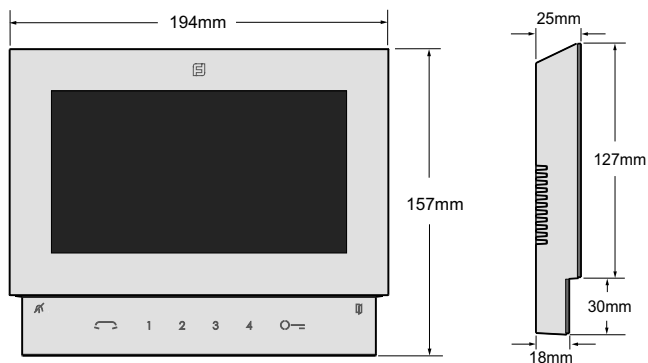
**Note.** The example refers to an apartment with 4 intercoms in parallel with intercom service. To allow for the individual intercom call between intercoms the internal station address must be changed in the other 3 intercoms by entering the following numbers (intercom 2 001, intercom 3 002 and intercom 4 003).



## Example of manual programming of a intercom



VIDEOINTERCOMS



**SE4252.** Colour video intercom with 7.0" LCD screen for DUO series. To enable the video intercom functions, 6 keys are available on the front panel; keys 1, 2, 3 and 4 can be used also to make intercom calls. A traditional handset can also be connected to the videointercom.

**Technical data**

Power supply: from the DUO line

Current:

- stand-by: 8 mA
- operating: 230 mA

Screen:

7" LCD

Operating temperature:

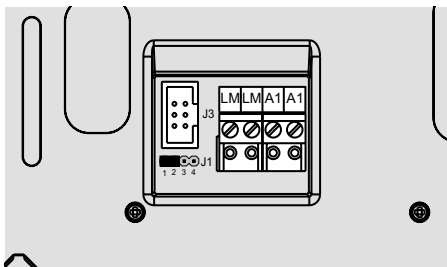
0 ÷ + 40 °C

Maximum humidity:

90% RH

**Terminal boards**

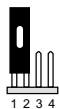
- LM / LM** Line inputs
- A1/A1** Floor call inputs
- J3** Handset connector



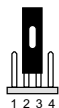
**Selecting the closing impedance**

The jumper **J1** provided on the back of the videointercom can be used to adjust the video signal coming from the riser and guarantee the correct operation of the devices connected to it.

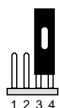
**J1 Jumper to adjust the impedance of the video signal**



**1-2** termination 100Ω (default)



**2-3** termination 15Ω

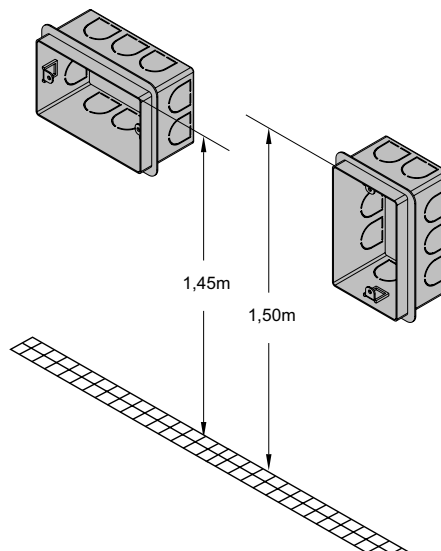


**3-4** open line

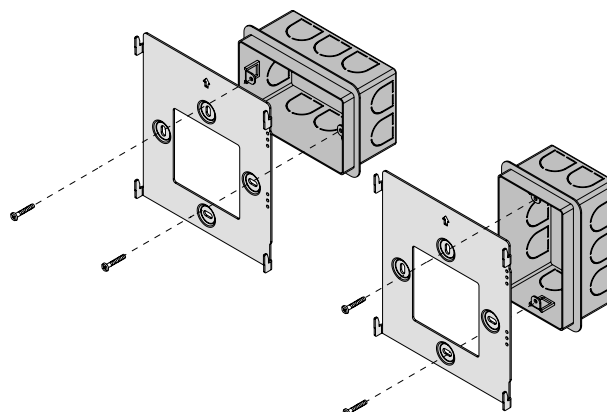
INSTALLATION

Flush mounting

**1** - Mount on the wall a built-in box of 83mm at approximately 1.45m /1,50m above the ground.

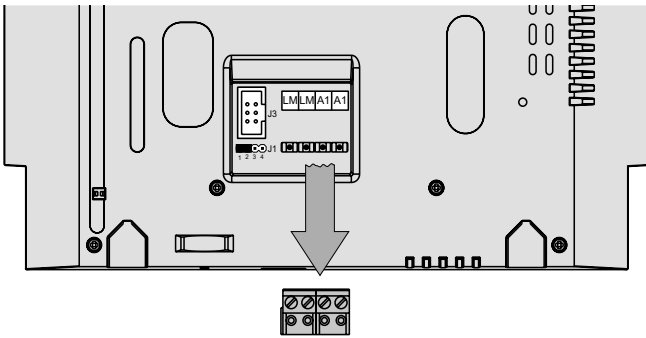


**2** - Screw the bracket to the built-in box.



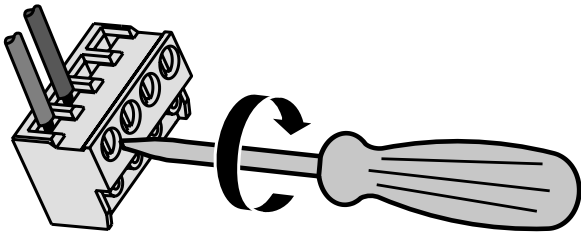
# INTERNAL STATIONS

3 - Unplug the terminal block from the videointercom.

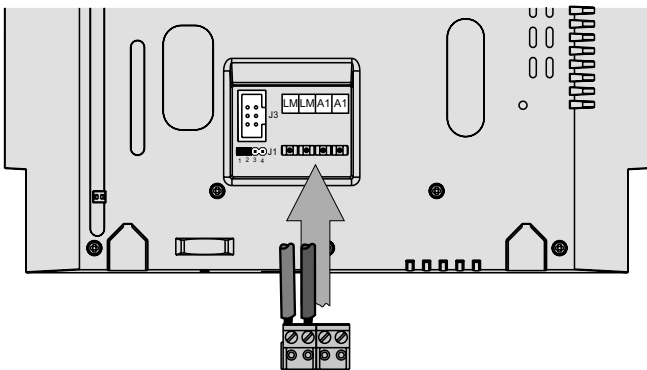


**Warning.** Do not use sharp objects to remove the terminal block.

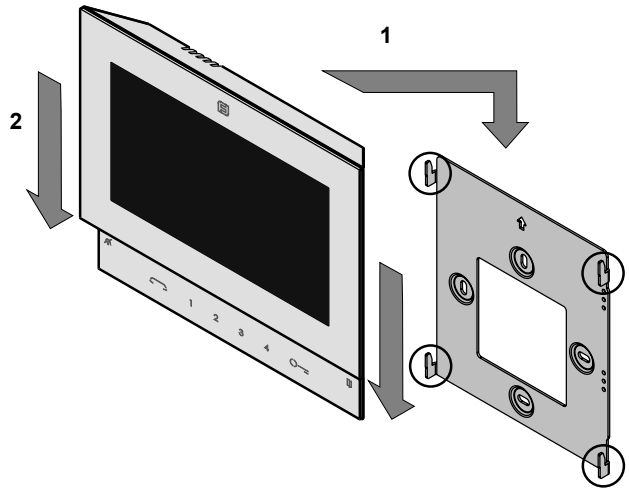
4 - Make the connections as required by the electric diagram.



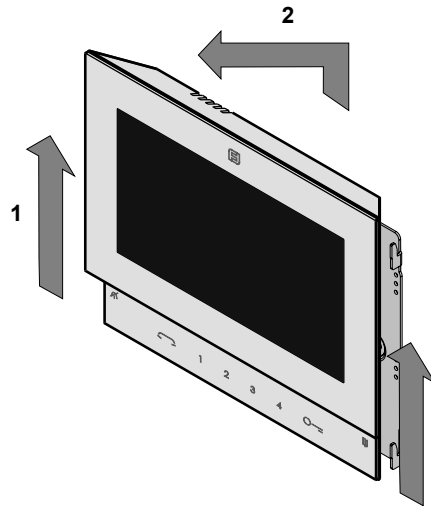
5 - Plug-in back the terminal block on the videointercom.



6 - Fix the video intercom to the wall bracket.



7 - Dismounting the video intercom.

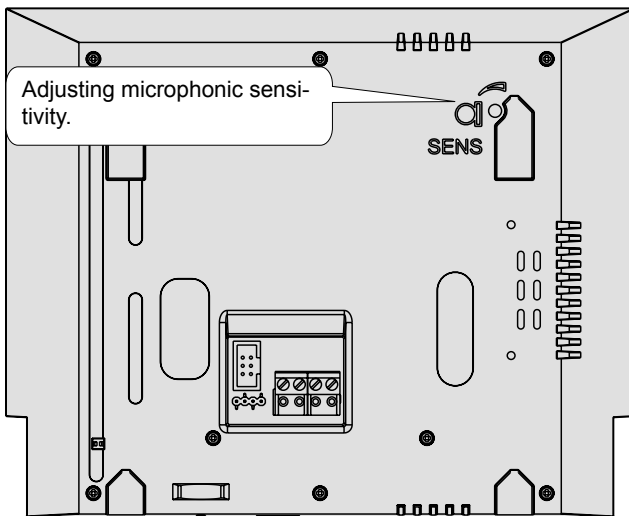


## Audio adjustment

The audio levels are set in the factory; settings on the back of the device must be changed only if really necessary.

### Setting the audio levels.

- If audio is excessively intermittent during the conversation or the speaker tends to distort it during the call, it is recommended to slightly change the microphone sensitivity using the SENS trimmer on the back of the video-intercom.
- For the speaker volume (see chapter "Audio-video adjustment").



## Additional functions

### Floor call

To receive a floor call you must connect a button (FP) between terminals **A1** and **A1** of the videointercom.

When the button FP is pressed, the videointercom speaker will receive a call different from calls from the external stations. The call is received also if the videointercom is in conversation.



SE4252

## SYSTEM PROGRAMMING

At the first start-up, the videointercom must be suitably programmed to define its operating mode. A wrong programming can affect negatively the operating of the whole system.

The possible programming ways are two:

- remote - it allows to program the videointercom using a DUO programming device or to program quickly only the device address of the intercom by making a call from the door station or the digital PABX (refer to the "Remote programming");
- manual - it allows to program all the parameters, by operating directly on the videointercoms..

### Definitions

- **User address** - Apartment identification address (addresses from 1 to 200). It allows to receive an external call or a call from another device installed in the same building, switch-ON the videointercom, have a conversation and open the door lock of the calling external door station. The address must be the same address saved in the call button of the push-button panel of the external door station or in the call button of another intercom device of the building.
- **Room number** - Identification number of a device inside the same apartment (addresses from 0 to 9). The room number establishes a hierarchy in the internal devices since the device with room number 0 (zero) will be the main device and all the other devices will be the secondary lines. Once you have made this programming, you will be able to make and receive selective calls with the other devices inside the same apartment. In other words, each device can individually call the other devices. The external calls or calls from another apartment will make all devices ringing, the first device that answers the call will activate the conversation and switch OFF the ringer of the other devices. When you receive a call from an external door station equipped with camera, all the devices will ring, but only the main device (room number 0 - zero) will display the camera image. In this phase you can display the camera image also from a secondary videointercom without answering by pressing the camera button . This operation will switch OFF the ringer and will display the camera image on the display of the used videointercom. To answer the call it is sufficient to press again the button . A floor call makes ringing only the videointercom to which the call button is physically connected. To forward the call to the other videointercoms you must follow the instructions contained in the section "A1 Forward"..
- **List of Users and devices** - In the list it is possible to save the name and the address of:
  - users of other apartments; it allows to call them selectively (addresses from 1 to 200);
  - videointercoms in the same apartment; it allows to intercommunicate with the equipment of other rooms in the same apartment (room number from 0 to 9);
  - door stations (not necessary in the case of a single door station); it allows the videointercom to connect them selectively, monitor the entrance and eventually release the door lock (addresses from 231 to 250);
  - actuators for supplementary services (supplementary door lock release, switch-ON of stair's light, etc.); it allows the videointercom to enable directly the actuators (addresses from 211 to 230).



**Warning:** the addresses stored in the videointercom must be the same of those programmed in the devices to call or to enable.

# INTERNAL STATIONS

## Main functions of the keys

The 6 frontal keys allow accessing commands and settings of the device and vary their function depending on the operating mode of the video intercom.

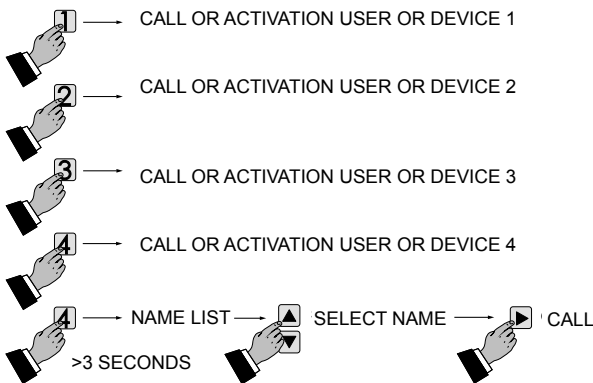
he keys can be used in two different ways:

- 1) short pressure
- 2) long pressure (over 3 seconds).

	Door Lock release
	Monitoring of door stations. Talk / Answer
	Mute / Unmute.
	When Mute icon  flashes
<b>1</b>	Call user 1 or Activation device 1
<b>1</b> >3 sec.	Settings / User adjustments
<b>2</b>	Call user 2 or Activation device 2
<b>3</b>	Call user 3 or Activation device 3
<b>4</b>	Call user 4 or Activation device 4. If more than 4 users and/or devices are stored, with a long pressure of button 4 (>3 seconds) you will access directly their list
<b>4</b> >3 sec.	Users or devices list. To call a user or to enable a device it is necessary to select it from the list with cursor up  (button 2) or down  (button 3) and press  (button 4)
<b>1+ 4</b> >3 sec.	System Programming

**Attention:** the first 4 users or devices of the Users and devices list can be directly called or activated pressing on the videointercom buttons "1", "2", "3" or "4".  
If there are more than 4 users, it is necessary to press for a long time button 4 (>3 seconds), on the screen appears the complete list of stored users and devices; to make a call select with buttons the desired user and press .

### MORE THAN 4 USERS OR DEVICES



### With OSD On

<b>1</b>	Cursor left - back - exit
<b>2</b>	Cursor up
<b>3</b>	Cursor down
<b>4</b>	Cursor right - forward - OK

**Attention.** During the pressure of a key, the dissuasion or busy tone indicates that the function is not available because the service is not active or the video intercom line is busy by another user.

## Factoring settings

User address	100
Room address	0
Secondary addresses	none

During following programming of the videointercom, current values are displayed in green.

## Enter programming mode

With the display switched OFF (without images or running conversations), keep pressed at the same time the buttons "1" and "4" for about 3 seconds; "Settings" menu is displayed, showing the following contents:

- Users and devices
- Audio
- System
- Language
- Misc(ellaneous)
- Default

**Attention.** To enter the programming mode it is necessary that all the videointercoms in the installation (including the one to be programmed) are switched OFF. If pressing the "1+4" for more than 3 seconds a dissuasion tone is heard, it means the above condition is not met.

During the programming phase the display could switch OFF suddenly for the following reasons:

- a call from a door station to any videointercoms in the system has been made;
- from any videointercom in the system the monitor function or a call to another has been made.

## Exit programming mode

Press "n" times the button (button 1) until the videointercom exits from programming. If for 60 seconds no operations are made the videointercom exits automatically from programming.

## Programming

- Users and devices - In the users and devices list can be stored up to 20 names and addresses of intercommunicating devices, door stations and actuators for supplementary services (example: Living Room - 1; Robert Brown - 104; Oxford Street - 231; Car Gate - 211).

Based on the device address, 4 different categories of "Users and devices" are fixed, every category is represented with a different colours of characters:

- Intercommunicating Devices (address from 1 to 200) violet colour
- Door Stations (address from 231 to 250) cyan colour
- Door Keeper Exchangers (address from 201 to 210) yellow colour
- Actuators (address from 211 to 230) grey colour

To start programming with buttons move the cursor to "Users and devices" and press ; the list of the following functions will be displayed:

- New
- Name 1 (if any)
- Name 2 (if any)
- Name .. (if any)
- Sorting

Insert the name and address of a user or a device.

- With buttons ▼▲ select "New" and press ►; the following functions will be displayed:
  - Label
  - Address
  - Room
  - Ring tone
  - Delete

- Label – Select "Label" to enter the name (max. 16 characters, upper and lower cases, numbers or symbols) you want to give to the device (example: Living Room; Robert Brown; Oxford Street; Car Gate) and press ►.

Insert the name using the buttons ▼▲ to search the characters (keep them pressed for fast searching) and confirm pressing ►; cursor automatically moves to the next character to enter. Search the 2<sup>nd</sup> character and confirm by pressing ►; repeat the same procedure to complete the name and press ►; press ► again to exit and display the "save" menu, with buttons ▼▲ select:

- "Cancel" to move back
  - "Save" to exit and store the name
  - "Don't save" to exit without saving it.
- press ► to confirm


Note. While entering the names, if you need to correct it, use buttons ◀▶ to move from one character to another.

- Address – Move the cursor to "Address" – press ►; the present address is shown (100 from the factory) – keep pressed buttons ▼▲ to increase or decrease the number of the address - press ► to confirm; the "save" menu is displayed, with buttons ▼▲ select:

- "Cancel" to move back
  - "Save" to exit and store the address
  - "Don't save" to exit without saving it.
- press ► to confirm.

Attention: the address stored in the contacts list must be the same address stored in the device you want to call (eg.: 104 address of Mr. Brown's videointercom; 231 address of Oxford street's door station; 211 address of car gate's actuator).

- Room

 The room number must be programmed only if it is required to call an intercommunicating device inside the same apartment (same user address) then if in the previous programmed parameter ("Address") has been programmed a different address compared to the user address of the videointercom you are programming, the parameter "Room" doesn't appear on the programming menu.

To change the room number (0 from the factory) operate as indicated in the following: - move the cursor to "Room" - press ►; the present room number is shown – keep pressed buttons ▼ or ▲ to increase or decrease the value - press ► to confirm; the "save" menu is displayed, with buttons ▼▲ select:

- "Cancel" to move back
  - "Save" to exit and store the room number
  - "Don't save" to exit without saving it.
- press ► to confirm.

- Ringing Tone - It is possible to assign to any user a personal ringing melody, to select the ringing melody it is necessary: - move the cursor to "Ringing Tone" - press ►; the list of available ringing melodies are displayed (in green the present assigned ringing melody). Use buttons ▼▲ to scroll the list and hear the melody; press ► to select the desired one. Press ◀ to go back to the previous menu.

- Delete - To delete a user from the list it is necessary to select the name from the list and press ►; using buttons ▼▲ select "Delete" and press ►; the "Save" menu is displayed, with buttons ▼▲ select:

- "Cancel" to exit without erasing the name
  - "Confirm" to erase it
- press ► to confirm.

Press ◀ to go back to "Users and devices" menu.

To insert other user names repeat all the above operations. If, in the contacts list, it is necessary to store 2 users with the same address (eg. wife and husband; apartment and professional office, etc.) it is sufficient to create 2 users with different names but the same address.

- Sorting - To change the order of the names in the contacts list it is necessary, once in the menu "Users and devices", select "Sorting" and press ►; with the buttons ▼▲ select the name you want to move and press ► – with the buttons ▼▲ move the name up or down in the list until you reach the desired position and press ► to confirm. Press ◀ to go back to the previous page.

Press ◀ to go back to "Settings" menu.



**Attention:** the first 4 users or devices of the list can be directly called or activated pressing buttons "1", "2", "3" or "4" on the videointercom.

Modify a name

To modify the data of a user it is sufficient, in the "Users and devices" menu, select the name and press ►; the following list will be displayed: Label, Address, Room, Ringing Melody, Delete; select the requested item and press ►; proceed as indicated in the chapter "Insert name and address of a user or a device".

Press ◀ to go back to "Settings" menu.

## ● Audio

It allows to choose the sound of door bell and the volume for all the ringing melodies tones. In the "Settings" menu select "Audio" and press ►; the following menu will be displayed:

- Door Bell (only for "floor call" – A1 terminal)
- Ring tone period
- Key tone
- Ring tone level
- Tone level.

- Door bell – select "Door bell" and press ►; with buttons ▼▲ select the desired melody and confirm by pressing ►, selected melody becomes green; press ◀ to go back to the "Audio" menu.

- Ring tone period - Select "Ring tone period" and press ►; with buttons ▼▲ increase or decrease ringing melody repetition period (from 0 to 30 seconds) and press ►; the "save" menu is displayed, with buttons ▼▲ select:

- "Cancel" to move back
- "Save" to exit and store
- "Don't save" to exit without storing data

press ► to confirm;

press ◀ to go back to the "Audio" menu.

- Key tone – it allows to activate or deactivate the tone while pressing the buttons on the videointercom. Select "Key tone" and press ►; with buttons ▼▲ select "Enabled" or "Disabled" and press ► to confirm, selected function becomes green; press ◀ to go back to the "Audio" menu.

- Ring tone level – it allows to increase (▲) or decrease (▼) the volume of all the ringing melodies of the videointercoms. Select "Ring tone level" and press ►; on the screen a vertical graphic

bar will appear displaying the present level. With buttons ▼▲ select the desired level of volume and press ► to confirm and go back to the "Audio" menu.

- Tone level - It allows to increase (▲) or decrease (▼) the volume of all the tones of the videointercoms. Select "Tone level" and press ►; on the screen a vertical graphic bar will appear displaying the present level. With buttons ▼▲ select the desired level of tones and press ► to confirm and go back to the "Audio" menu.

Press ◀ to go back to "Settings" menu.

## ● System

Move the cursor to "System" and press ►; the main settings of the videointercom will be displayed with the following functions:

- Address
- Room
- Additional addr(ess)
- Remote program(ming)
- A1 forward.

- Videointercom Address (addresses from 1 to 200) - Move the cursor to "Address" – press ►; the previously programmed address will be shown (100 from the factory) – keep pressed the button ▼ or ▲ to increase or decrease the number of the address – once displayed the requested address press OK; the "save" menu is displayed, with buttons ▼▲ select:

- "Cancel" to move back
- "Save" to exit and store the address
- "Don't save" to exit without saving it

press ► to confirm.

- Room (from 0 to 9) - Move the cursor to "Room" – press ►; the previously room number will be shown (0 from the factory) – keep pressed the button ▼ or ▲ to increase or decrease the number of the room - once displayed the requested room number press ►; the "save" menu is displayed, with buttons ▼▲ select:

- "Cancel" to move back
- "Save" to exit and store the room number
- "Don't save" to exit without saving it.

press ► to confirm.

## - Additional addresses

You can set the videointercom so that it answers the calls sent to other users (secondary addresses); for example, the house of a professional and his professional office, or parents' apartment and sons' apartment. In this way the videointercom of an apartment can operate as a videointercom, either main or secondary, of another apartment. It is important to remember that, in case of a videointercom with alternative address, the videointercom operates either as a videointercom of its own apartment or as videointercom of the alternative apartment so that it must respect also the rules and programming operations of the latter.

Example. If the room number 2 is already used in the alternative apartment, the alternative videointercom cannot be programmed with room number 2. Of course, it can be room number 2 of its own apartment, if available. If there is a main videointercom in the alternative apartment, the alternative videointercom cannot be programmed as main videointercom, it can be the main videointercom for its own apartment if requested.

To program the "secondary address" function you must proceed as indicated below:

- move the cursor to "Secondary addresses" - press ►; 4 empty labels will be displayed if no one has been previously programmed - select the first empty one and press ►;
- select "Address" and press ►; keep pressed the button ▼ or ▲ to increase or decrease the secondary address (addresses

from 1 to 200) - once displayed the requested address press ►; the "save" menu is displayed,

with buttons ▼▲ select:

- "Cancel" to go back
- "Save" to exit and store the address
- "Don't save" to exit without saving it.

press ► to confirm.

- select "room" - press ►; – keep pressed the button ▼ or ▲ to increase or decrease the room number (from 0 to 9) – once displayed the requested room number press ►; the "save" menu is displayed, with buttons ▼▲ select:

- "cancel" to go back
- "save" to exit and store the room number
- "don't save" to exit without saving it.

press ► to confirm

Press ◀ to go back to the "Secondary addresses" menu.

Continue, if necessary, to program more secondary addresses or press ◀ to go back to the "System" menu.

- Remote programming - Videointercom can be programmed by means of:

- a DUO programming device
- a door station or a door keeper exchanger

To use a DUO programming device it is necessary:

- select " Remote programming" and press ►, on the screen a "Remote programming" window appears; within 2 minutes it is necessary to connect to the system a DUO programming device and start programming. At the end of the programming it is necessary to exit the "Remote programming" menu by pressing button ◀.

The user address of the videointercom can be programmed from remote also making a call from a door station or a door keeper exchanger.

- Move the cursor to "Remote programming" – press ►; within 2 minutes make a call from the door station or the door keeper exchanger to the address to be stored. In systems with a digital keypad, key-in the address to be stored and press "▲"; in systems with a digital encoding module or buttons modules, press the button you want to assign to the videointercom under programming; in systems with the door keeper exchanger PDX2000, pick up the handset, key-in the address to be stored and press "◀". Automatically the videointercom will ring, press the button "☎" to communicate with the calling device and check the correct operations of the system; the calling device will emit an acknowledge tone if remote programming has been accepted or a dissuasion tone if remote programming has been refused.

- Repeat the above described operations for all the videointercoms in the system.

At the end exit "Remote programming" pressing button ◀

- A1 forward (Door Bell) - The floor call only rings the videointercom to whose A1 terminals are connected the bell button; to forward the call to all the other devices in the same apartment or to a device in an other apartment it is necessary to operate as in the following:

- select "A1 forward" and press ►; on the screen appears the list of the functions that can be enabled (active function is in green), with buttons ▼▲ select:
- "Disabled" to disable the function and press ► to confirm; press ◀ to move back to the "System menu"

"Enabled" to enable the function and press ► to confirm, in this case it is necessary to enter also the user address to which forward the floor call. With buttons ▼▲ select:

- "Address" and press ► - Enter your own user address if you want to make ringing all the intercommunicating devices in your apartment - Enter the user address of another apartment if you require to make ringing the main videointercom (room number 0) of another apartment. With buttons ▼▲ select the required user address and press ► to confirm; the "save" menu is displayed, with buttons ▼▲ select:
  - "Cancel" to go back
  - "Save" to exit and store the address
  - "Don't save" to exit without saving it. press ► to confirm.

Press ◀ to move back to the "System" menu.

Press ◀ to move back to the "Settings" menu.

- Language – Move the cursor to "Language" and press ►; list of available languages is displayed, scroll the list with buttons ▼▲ - select the requested language and press ► to confirm, the chosen language becomes green.

Press ◀ to move back to the "Settings" menu.

- Miscellaneous - Move the cursor to "Miscellaneous" and press ►, the entry "OSD" is displayed, it allows to set the time for which to show the OSD on the screen. Select "OSD" and press ► a windows with the OSD time already set is displayed (from 0 to 255); with buttons ▼▲ select a new OSD time considering that 0 means OSD always OFF and 255 means OSD always ON and than press ► to confirm; the "save" menu is displayed, with buttons ▼▲ select:

- "Cancel" to go back
- "Save" to exit and store the new OSD time
- "Don't save" to exit without saving it. press ► to confirm

Press ◀ to go back to the "Settings" menu.

- Default - Back to the factory settings. This command erase all the settings previously stored (except "Users and devices" list) and restore the videointercom back to the factory settings. Select "Default" and press ►, the "save" menu is displayed, with buttons ▼▲ select:
  - "Cancel" and press ► to go back to the "Settings" menu without restoring the videointercom to the factory settings"
  - "Confirm" and press ► to go back to the "Settings" menu restoring the videointercom to the factory settings.

## USER SETTINGS MENU

The following settings can be changed by the user without affecting the correct operations of the videointercom or of the whole system. User can change:

- user name in the contacts
- volume levels of ringing melodies and tones
- ringing melodies
- language

Functions of the keys during user settings

1 >3 sec.	User settings / Adjustment
1	◀ Cursor left - back - exit
2	▲ Cursor up
3	▼ Cursor down
4	► Cursor - right - forward - OK

While the videointercom is OFF, press for a long time the "1" button (>3 seconds); user menu is displayed:

- Users and devices
- Audio
- Language

- Users and devices – In the list, if programmed during the installation of the videointercom, are shown the name of users, door stations and actuators whose sorting, ringing melody and name can be changed.

Move the cursor to "Users and devices" and press ►; the list of users-devices (eg. Living Room, Mr. Robert Brown, Car gate) and the "Sorting" option are displayed:

- Living Room (if previously stored)
- Robert Brown (if previously stored)
- Car Gate (if previously stored)
- Sorting

- To change a name and the associated ringing melody it is necessary to select the name using buttons ▼▲ and press ►; the following functions are displayed:

- Label
- Ringing melody

- Label – Refer to "Users and devices programming
  - Ringing tone – Refer to "Users and devices programming
- Press ◀ to go back to "Users and devices" menu.

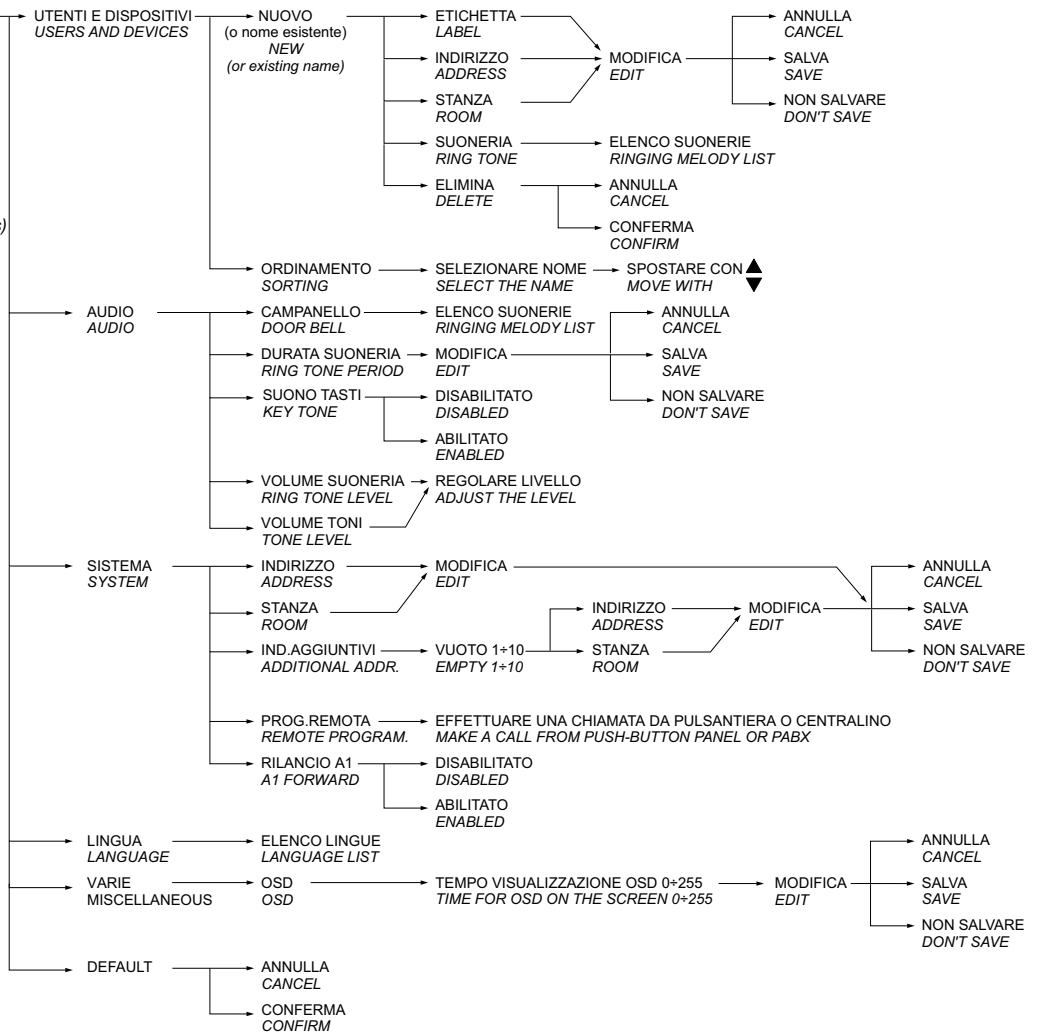
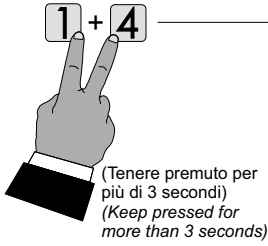
Repeat all the above operations to change other user names or press ◀ to go back to "User settings" menu.

- Sorting of names  
To change the order of names in the contact list it is necessary to select "Sorting" in the "Users and devices" menu and press ► – select the name to move and press ► – with ▼▲ buttons move the name up or down until it reaches the desired position and press OK to confirm.  
Press ◀ to go back to "Users and devices" menu.

Press ◀ to go back to "User settings" menu.

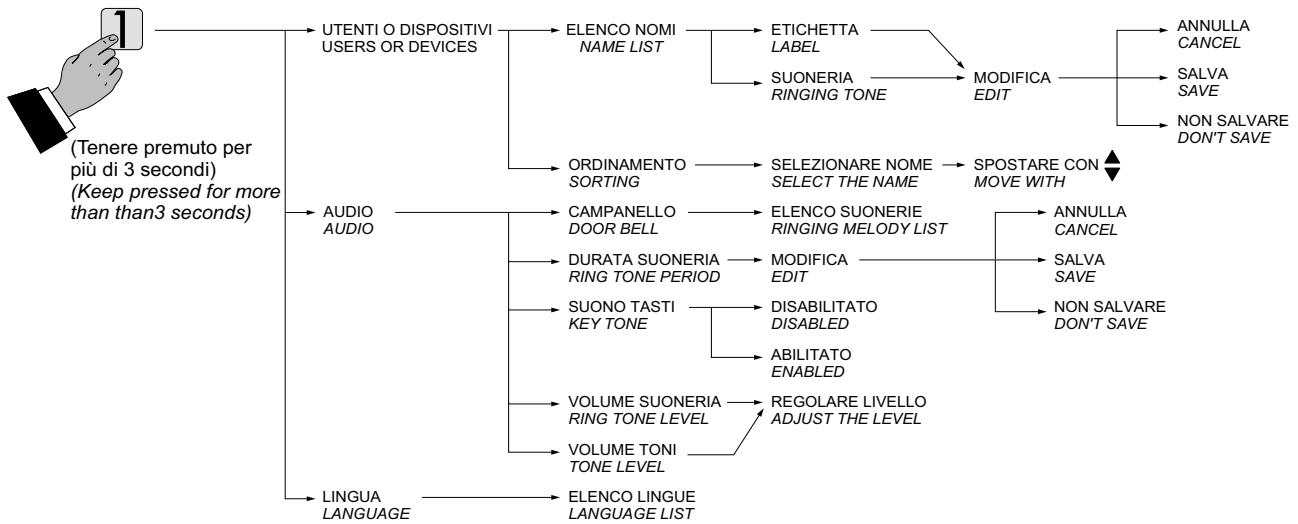
- Audio - Refer to Programming - "Audio".
- Language - Refer to Programming - "System" - "Language".

## SYSTEM SETTINGS MENU





## USER SETTINGS



### Audio-video adjustments

To adjust audio and video parameters it is necessary that the videointercom will be ON and connected to an external door station. To make "Adjustments" press for long time (>3 seconds) button "1"; following entries will appear on the screen:

- Audio level
- Brightness
- Contrast
- Colour

With cursors ▼▲ select "volume" and press ►; on the screen a vertical graphic bar will appear displaying the present level, with cursors ▼▲ adjust the audio level from the door station (loudspeaker volume) and confirm with button ►.



If it is required to adjust the quality of the image select with the cursors ▼▲ "Brightness" - "Contrast" - "Colour" and press ►; on the screen a vertical graphic bar will appear displaying the present level, with cursors ▼▲ make the required adjustments and confirm with the cursor ►. While the videointercom is monitoring a door station, pressing for long time (>3 seconds) button "1" only Video adjustments will be displayed (because there is no audio).



If the videointercom is in communication with another user, pressing for long time (> 3 seconds) button "1" only Audio adjustments will be displayed (because there is no image on the screen).


To exit the "Adjustments" menu press button ◀.

## OPERATION




### Call from the door station










When a call is made from the door station, the videointercom starts ringing and for around 30 seconds the image of the caller is displayed on the screen. To start the conversation, for around 90 seconds, press the button , to end the conversation before the conversation time expires press again button .


In case of a call to a user with more than one videointercom in parallel in the same apartment, all the videointercoms will ring, but only the videointercom with room number 0 will turn ON. To answer from this videointercom follow the instructions above. It is also possible to answer from any other videointercom of the apartment by pressing on it button , this videointercom will turn ON and at the same time the intercom that had been turned ON before, switches OFF. If, after having seen the image, you wish to talk with the calling door station, press again the button .

To operate the electric door lock release press the button ; this command operates even if any call hasn't been received, but in this case the command will operate the electric lock release of the last door station which has made a call.


During a communication, pressing for long time button "1" (>3 seconds), the Adjustment menu will be displayed and it is possible to adjust the audio level and the image quality (refer to paragraph "Audio-video Adjustments").

Pressing for a long time button "4" (>3 seconds) the list of the devices which can be enabled during the conversation is displayed; to enable a specific device select it using buttons   and press . In the devices list there are also 2 system functions:




- Camera
- Mute
- "Camera" function allows to switch the image among additional cameras connected to the door station; to switch the images it is necessary to select "Camera" using buttons   and confirm with , each time button  is pressed, the image switches from one camera to another; if there aren't additional cameras in the system, pressing button  the screen always displays the image from the door station.
- "Mute" function allows to disable audio towards the door station (no audio to the door station, but audio from the door station). To enable the "Mute" function during a conversation it is required to select it using buttons   and confirm by , "Mute" function will be activated and it becomes green. Press again button  to toggle between "Unmute" and "Mute".

Press button  to exit the devices list.



Monitor function and connection with one or more external door stations.

With the system in stand-by and no any conversation in progress, it is possible to monitor the external door stations by pressing the button  on the videointercom. If the installation includes more external door stations to monitor them selectively it is possible to use button "1", "2", "3" and "4" if properly programmed. To program buttons refer to "Programming". The monitor function lasts about 30 seconds, but will be interrupted in case of a call from an external door station.

Monitor function can be executed also selecting the entrance to monitor from the "Users and devices" list:




- press for a long time button "4" (>3 seconds), the list of pre-stored door stations will be displayed on the videointercom screen
- with buttons   select the door station to monitor
- press button  to power ON the monitor showing the image from that entrance.

In the "Users and devices" list it is present the function "Camera" which allows to show the images coming from additional cameras connected to a door station; for operating mode refer to the paragraph "Call from door station".

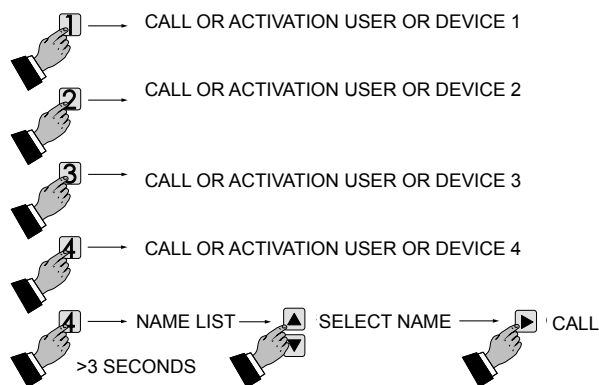
If pressing the button  (or button  when selecting the door station from the list "Users and devices") the videointercom remains switched OFF and a busy tone is heard, the system is busy and it is necessary to wait until the system becomes free.

Making or receiving a call from another user or from another device in the same apartment.

When the installation is in stand-by, you can make an intercommunicating call to another user or to another device in the same apartment; you must have stored the names and address of the desired users and devices in the "Users and devices" list (refer to Programming - "Users and devices").

The first 4 users of the list can be directly called pressing buttons "1", "2", "3" e "4", if there are more than 4 users, it is necessary to press for a long time button 4 (>3 seconds), on the screen appears the complete list of stored users and devices; to make a call select with buttons   the desired user and press ; on the screen will appear the name of the called user and you get the calling tone.

### MORE THAN 4 USERS OR DEVICES






If you get a busy tone, wait until the system becomes free and call again.


The videointercom of the other user will ring (without switching-ON) with the programmed melody. If the called user answers within 30 seconds, a 90-second conversation starts, otherwise the system goes back to free.

The internal conversation will be automatically interrupted in case of call from external door station to any other user.

### Turn OFF the ringtone

Ringing Melodies can be switched OFF pressing for a long time button  (>3 seconds); icon  flashes to indicate that Ringing Melodies have been switched OFF and continue flashing until Ringing Melodies will be switched ON pressing again for a long time button  (>3 seconds).

### Door open warning

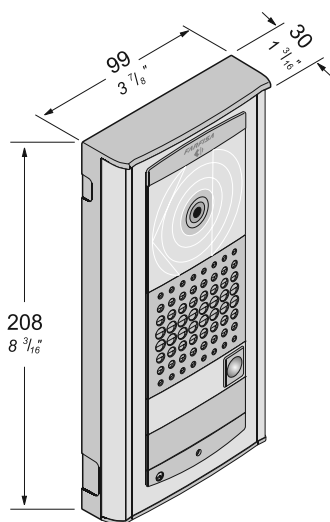
In systems properly designed, it is possible to get on the videointercom a warning signal according to the state of the entry door (open/closed); when entry door is open icon  will flash.

## Chapter 3

# DOOR STATIONS

	<i>Page</i>
<b>AGORA' series</b> _____	<b>3.2</b>
- Adjustments	3.3
- Installation	3.4
- Programming	3.7
- Operation	3.10
<b>PROFILO series</b> _____	<b>3.11</b>
- Adjustments	3.12
- Installation	3.13
- <b>Digital push-button panel</b> _____	<b>3.14</b>
- Programming	3.14
- Operation	3.17
- <b>Digital encoders</b> _____	<b>3.20</b>
- Programming	3.20
- Push-button modules	3.26
- Programming	3.26
- Operation	3.30
<b>MATRIX series</b> _____	<b>3.31</b>
- Adjustments	3.32
- Installation	3.33
- <b>Digital push-button panel</b> _____	<b>3.35</b>
- Programming	3.35
- Operation	3.40
- <b>Digital encoders</b> _____	<b>3.41</b>
- Programming	3.41
- Push-button modules	3.44
- Programming	3.44
- Operation	3.45

Surface mounting door stations with reduced width and thickness. Installation is easy and quick because no recessed box is required. Front plate is in extruded anodized aluminium. Name plates are backlit with blue LED's for a better reading even in dark places. Reduced dimensions and surface mounting features make the product particularly suitable for the installations on the entry gate's post.



**VD2121CAG / VD2121CAGL.**

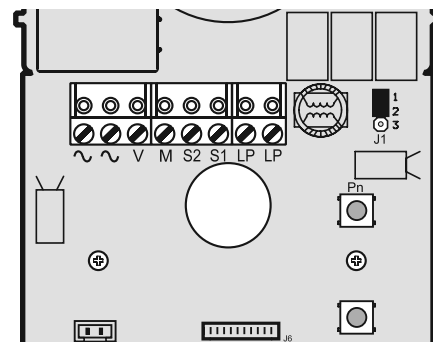
**Video door stations** with colour camera and amplified door speaker.

**Technical data**

Power supply	13Vac±1
Absorption	0.8A
Video signal standard	PAL
Minimum illumination	2.5 Lux
LED's	4 (white) + 2 (red)
Sensor	CCD 1/3" colour
Number of pixels	291,000
Lens	3.6mm
Focus	0.6m ± ∞
Horizontal/vertical adjustment	±10°
Operating temperature	-10°++40°C
Max. permissible humidity	80%RH

**Terminals**

- ~ ~ 13VAC voltage input
- V Video signal input of a supplementary external camera (coaxial cable)
- M Video ground (coaxial shield)
- S1/S2 Door opening contacts
- LP/LP Audio-data-video to/from internal users



**AD2121CAG / AD2121CAGL.**

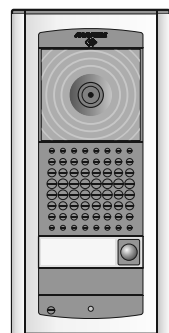
**Audio door stations** with amplified door speaker.

**Technical data**

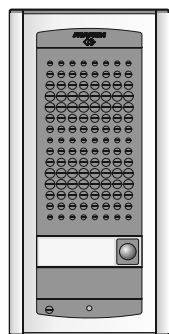
Power supply	13Vac±1
Absorption	0.7A
LED's	2 (red)
Operating temperature	-10°++40°C
Max. permissible humidity	80%RH

**Terminals**

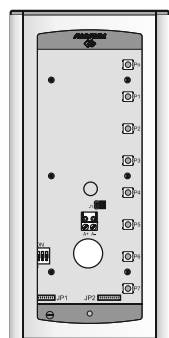
- ~ ~ 13VAC voltage input
- V Video signal input of a supplementary external camera (coaxial cable)
- M Video ground (coaxial shield)
- S1/S2 Door opening contacts
- LP/LP Audio-data-video to/from internal users



**VD2121CAG. Video door station** composed of an ABS box for surface mounting, front plate in aluminium with 1 call button and electronic board with colour camera, amplified door speaker and LED's for lighting the nameplates. You can add an additional **AG21** call button.



**VD2121CAGL.** Light grey version. You can add an additional **AGL21** call button.

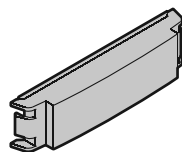


**AG100TS. Push-buttons door station** composed of an ABS box for surface mounting, front plate in aluminium and electronic board with diodes and LED's for lighting the nameplates. You can add 8 additional **AG21** call buttons.

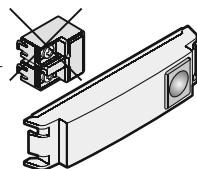
**AGL100TS.** Light grey version. You can add 8 additional **AGL21** call buttons.



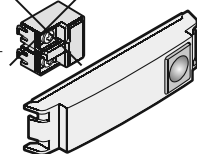
**AG20.** Blank module.



**AGL20.** Light grey version.



**AG21.** Single button module with name plate holder.



**AGL21.** Light grey version.

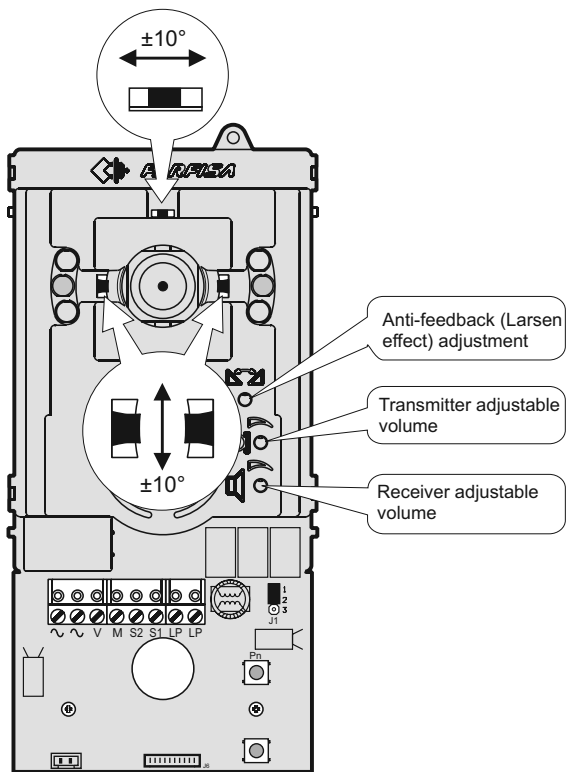


Do not use

## Adjustments

### Sweeps (only VD2121CAG)

If necessary, you can manually change the camera framing by adjusting the horizontal and vertical levers in the desired direction (see figure).



### Volumes adjustment

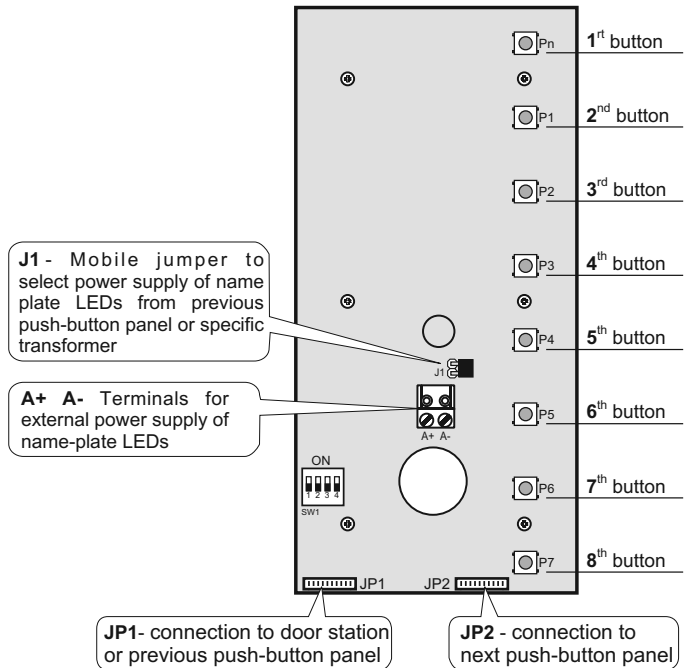
To adjust the volume of microphone and loudspeaker, turn the trimmers and .

### Anti-feedback adjustment (Antilocale)

In case of "feedback" (Larsen effect) in the external unit it is necessary to operate as follow:

- make the call from the door station and lift the handset of the called user;
- remove the microphone from its housing inside the push-button panel, place it on the loudspeaker of the electric door answering system and adjust the until the feedback stops;
- replace the microphone in its housing.

## AG100TS/AGL100TS. Push-buttons door stations.

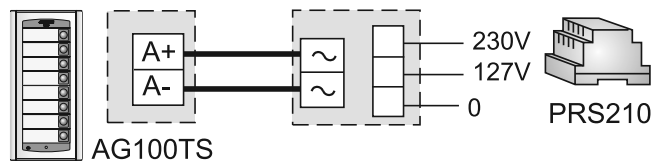
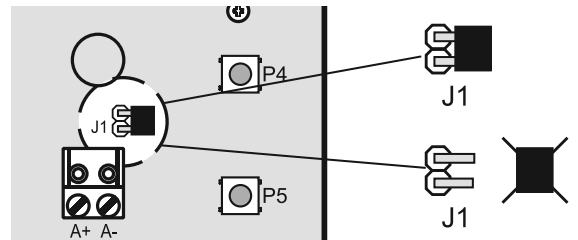


### Name-plate lighting

The power supply of the name-plate LEDs must be provided by a specific transformer. The PRS210 can power 6 push-button panels.

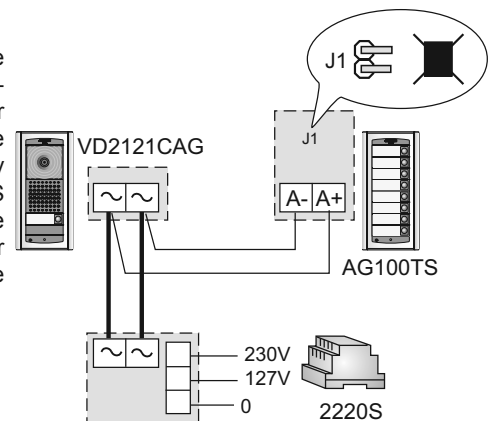
To make the connection, you must:

- remove the jumper that connects the two poles of J1 of the first push-button panel you want to power externally;
- connect the two power cables to terminals A+/A-;



- the next push-button panels must have the jumper inserted and the free terminals, being powered by the connection cables.

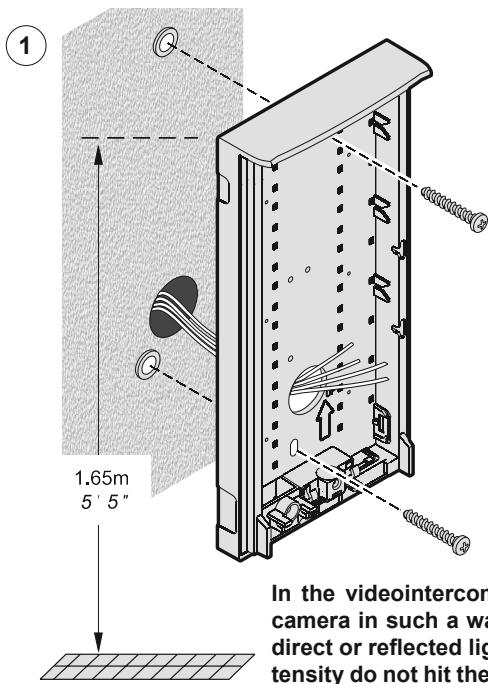
**Note:** in case of a single additional AG100TS push-button panel the power supply of the name-plate LEDs can be provided by the transformer art. 2220S that powers the VD2121CAG external door station, as shown in the figure.



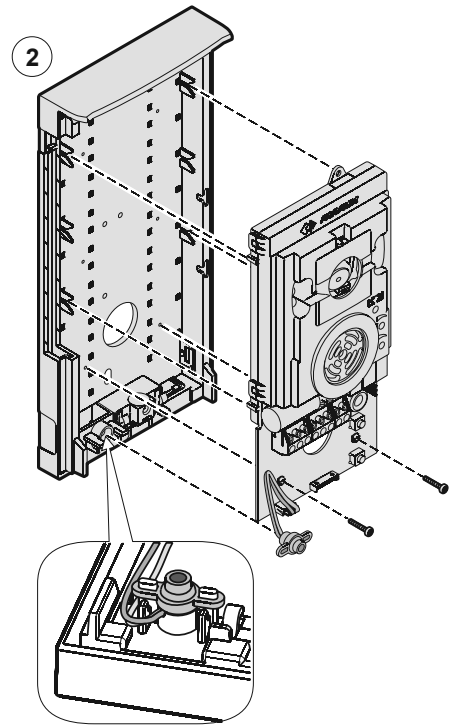
# DOOR STATIONS

## INSTALLATION

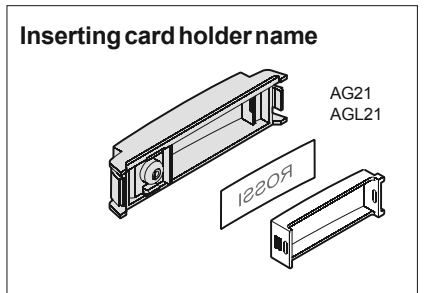
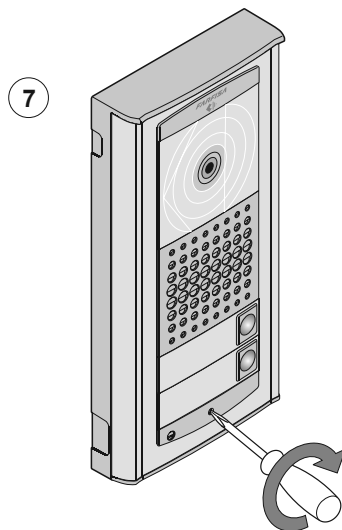
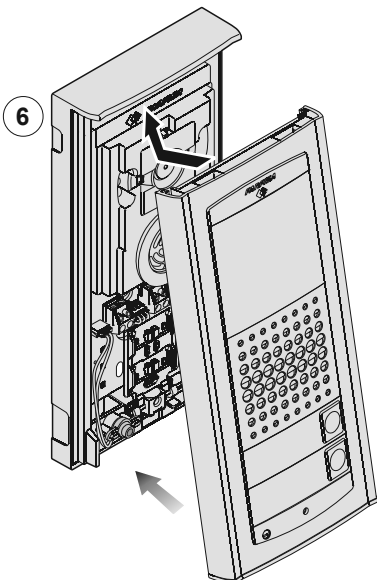
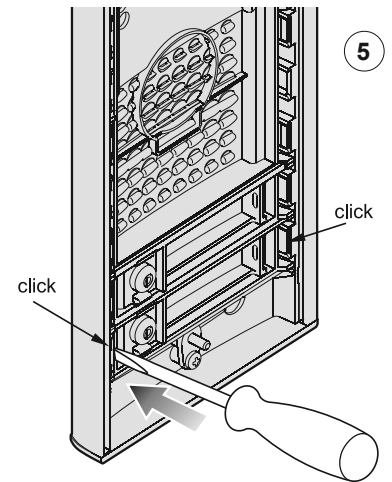
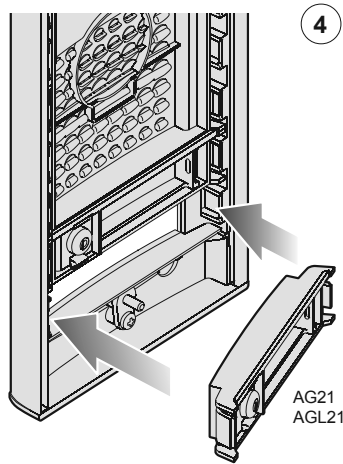
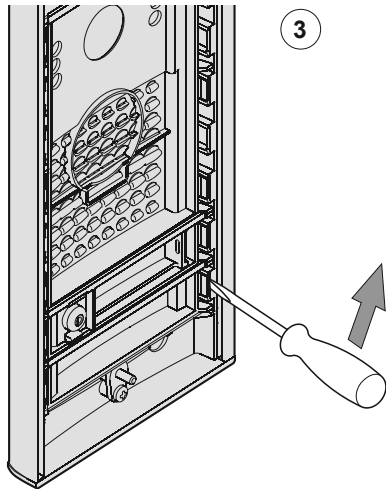
### ASSEMBLING DOOR STATIONS VD2121CAG, VD2121CAGL, AD2121CAG AND AD2121CAGL



In the videointercom systems, position the camera in such a way that sunlight or other direct or reflected light sources with high intensity do not hit the camera lens.

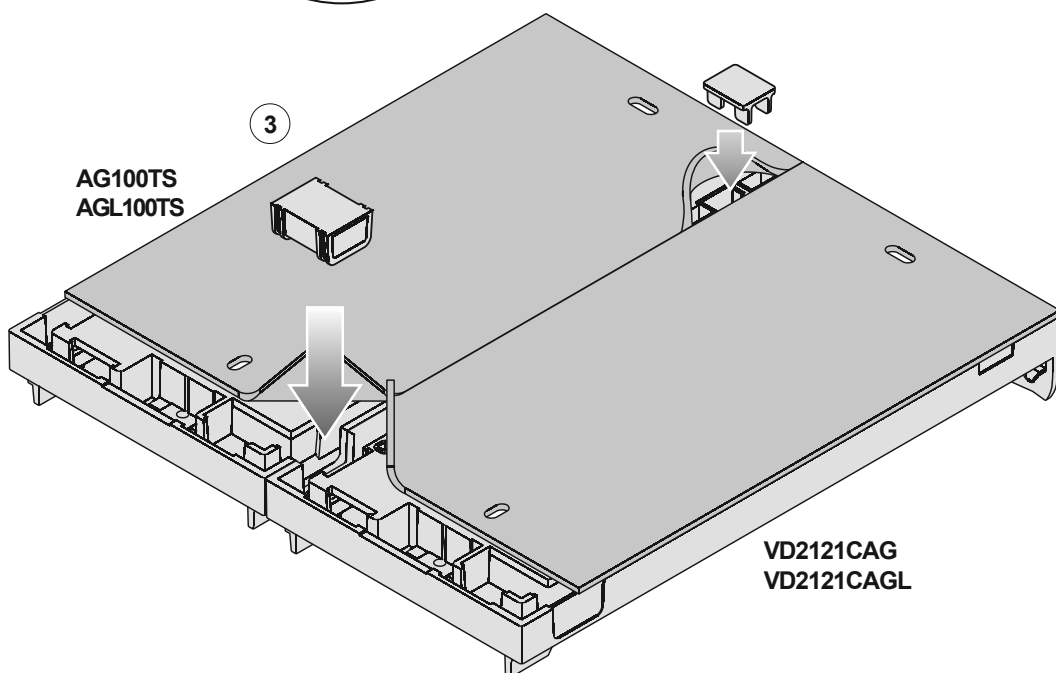
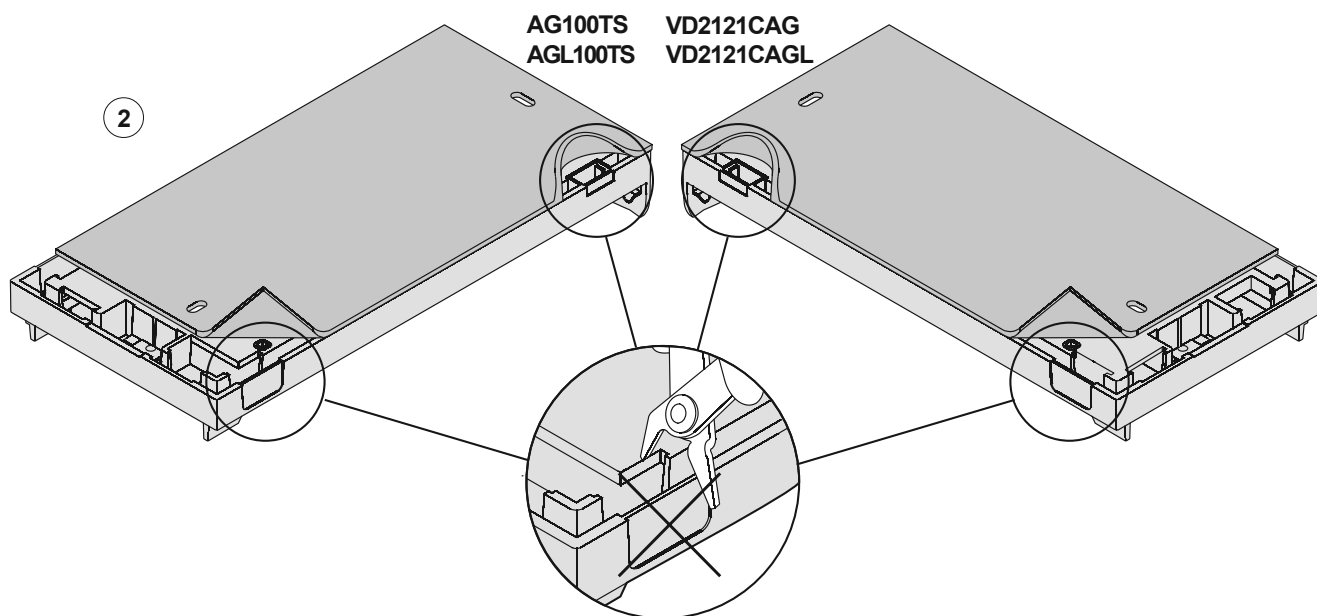
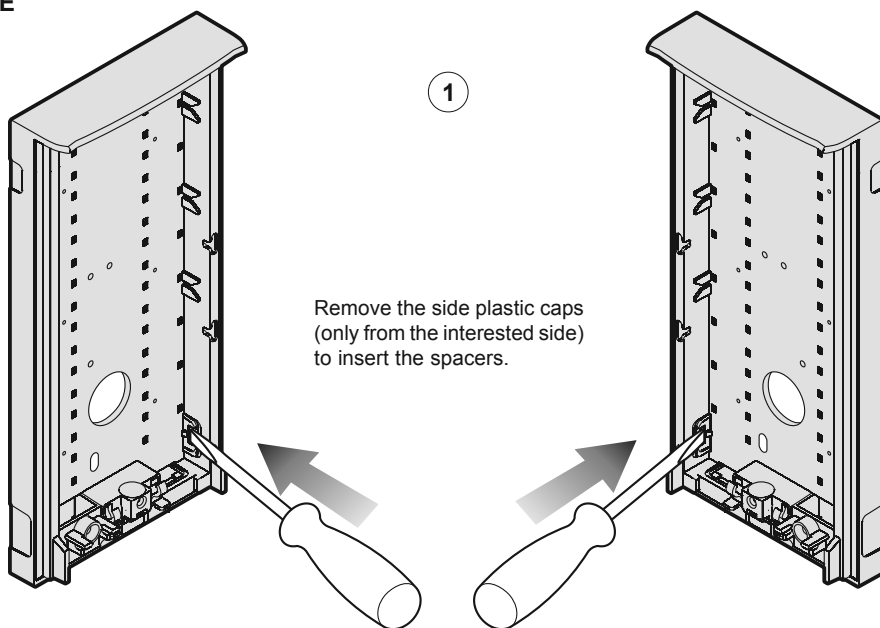
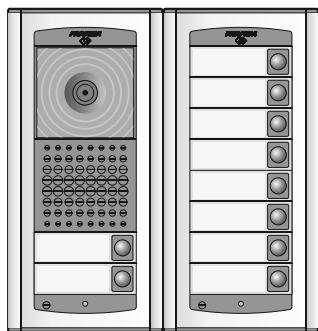


### Application of second additional button on external plate

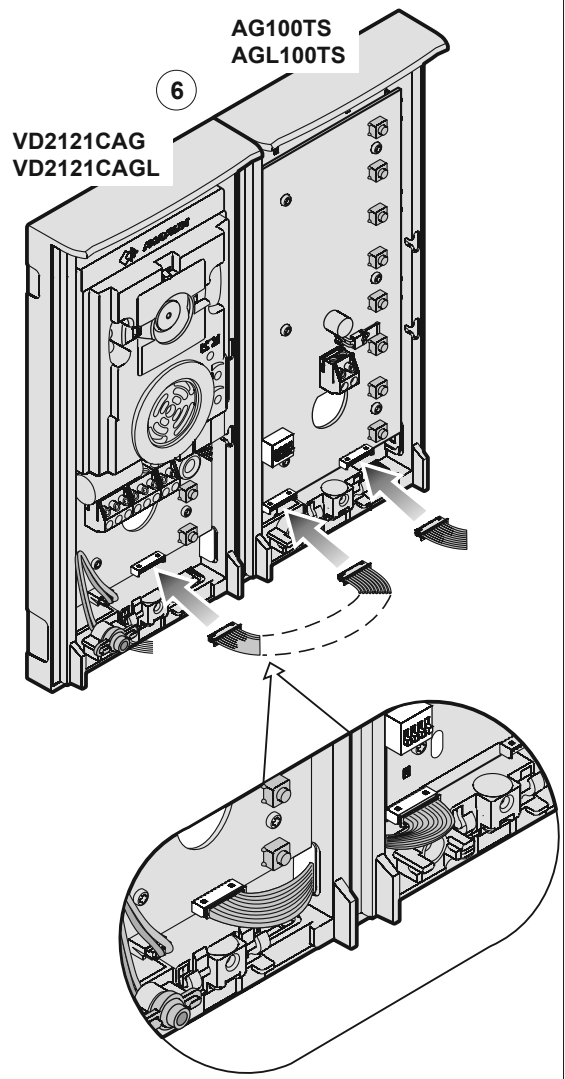
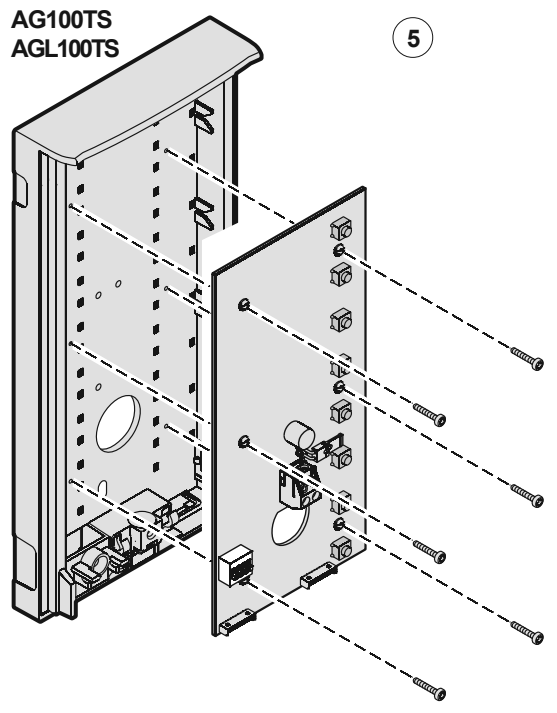
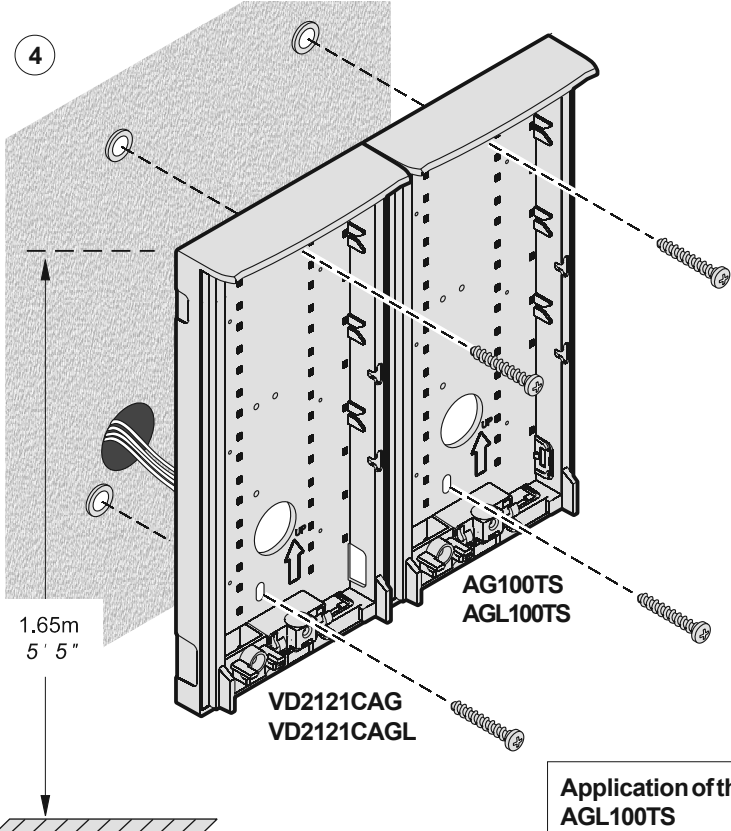


# DOOR STATIONS

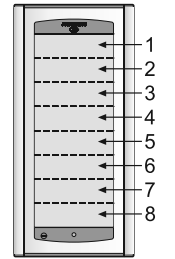
## ASSEMBLING DOOR STATIONS SIDE BY SIDE



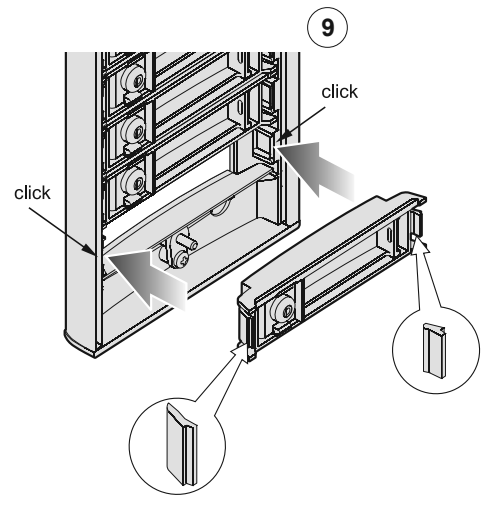
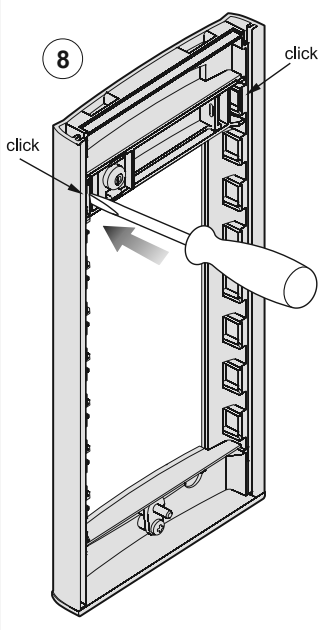
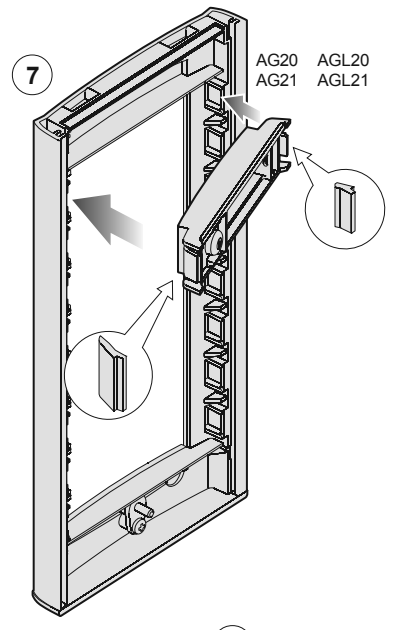
# DOOR STATIONS



## Application of the buttons on frontal plate of the door stations AG100TS and AGL100TS



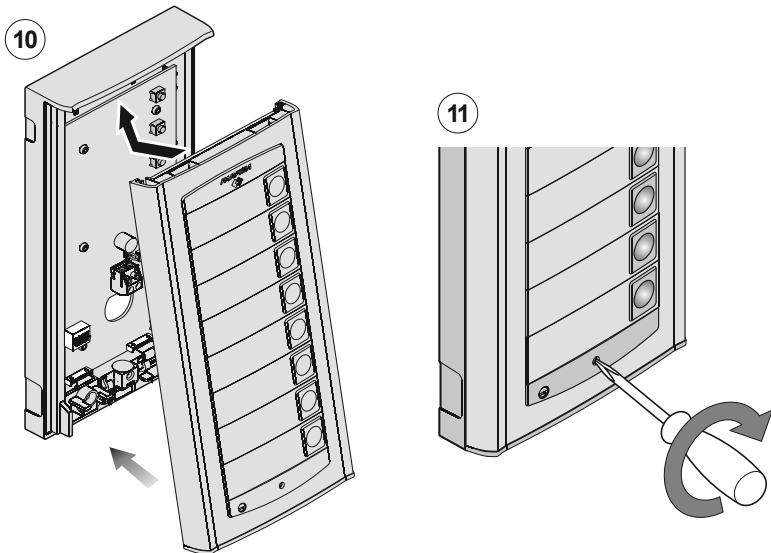
Insert the push-buttons or blank modules starting from the top of the frontal plate



DUO system

AG-CORÀ





Composition door stations and requested quantities of modules

Nr buttons	VD2121CAG	AG100TS	AG20	AG21
	VD2121CAGL	AGL100TS	AGL20	AGL21
1	1	-	-	-
	2	-	-	1
3	1	1	6	2
	4	1	5	3
5	1	1	4	4
	6	1	3	5
7	1	1	2	6
	8	1	1	7
9	1	1	-	8
	10	1	-	9
11	1	2	6	10
	12	2	5	11
13	1	2	4	12
	14	2	3	13
15	1	2	2	14
	16	2	1	15
17	1	2	-	16
	18	2	-	17
19	1	3	6	18
	20	3	5	19
21	1	3	4	20
	22	3	3	21
23	1	3	2	22
	24	3	1	23
25	1	3	-	24
	26	3	-	25
27	1	4	6	26
	28	4	5	27
29	1	4	4	28
	30	4	3	29
31	1	4	2	30
	32	4	1	31
33	1	4	-	32
	34	4	-	33

Note. For intercom installations replace art. VD2121CAG (or VD2121CAGL) with AD2121CAG (or AD2121CAGL)

## PROGRAMMING

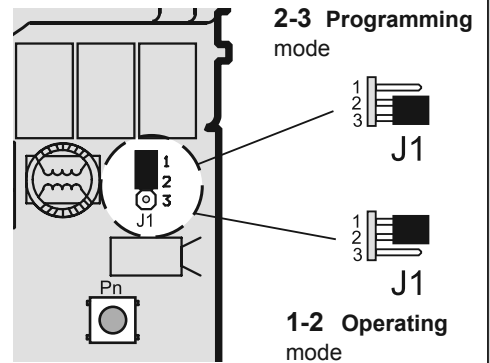
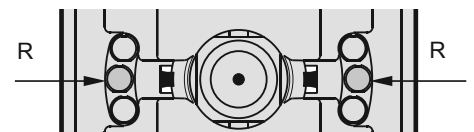
Following is a list of default settings. If necessary, follow the instructions contained in the next chapters to change them.

### Factory setting

- External Door Station Address = **231**
- Address associated with First Button = **100**
- Address associated with First Button of first additional push-button panel = **102**
- Lock actuation time = **3 seconds**
- Buttons with special functions = **none**
- Programming system = see table 3.2 on page 3.9

### Entering the programming mode

- Remove the plate.
- Move the jumper **J1** from position **1-2** to **2-3**; you hear the programming tone and the red LEDs turn ON (R).



### Exit the programming mode

To exit the programming mode, you must bring the jumper **J1** from position **2-3** back to position **1-2**.

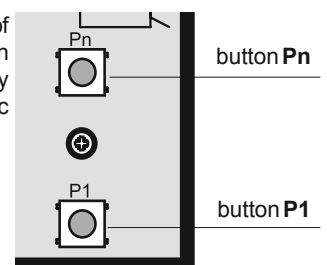
### Using the push-buttons for programming

Press button "**Pn**" and "**P1**" to enter addresses or codes.

**Pn**: Press this button to **confirm code programming** or **go to the next programming step**.

**P1**: Press this button to **increase the value you want to enter**. Press the button for a number of times equal to the digit you want to enter (digit 1 = 1 time; digit 9 = 9 times; digit 0 = press "**P1**" 10 times).

The pressure of the "**P1**" button is confirmed by an acoustic tone.



## Entering codes or addresses

- Codes and/or addresses must have three digits (hundreds, tens, units); codes and/or addresses with tens and units or units only must be completed by adding zeros. For example, address 96 becomes 096 and address 5 becomes 005.
- Enter one digit at a time by pressing the “P1” button for a number of times “n”, where “n” is the value of the digit you want to enter, followed by a pause of about 2 seconds before you go to the next digit (a tone on the loudspeaker will tell you when to go to the next digit). The maximum value you can enter is 255. For example, to enter code 096 you must:
  - press the “P1” button 10 times to enter digit 0 and wait for 2 seconds until you hear a tone in the loudspeaker.
  - press the “P1” button 9 times to enter digit 9 and wait for 2 seconds until you hear a tone on the loudspeaker.
  - press the “P1” button 6 times to enter digit 6 and wait for 2 seconds until you hear a tone on the loudspeaker.

**Note:** - remember to confirm the codes you have entered as explained in the programming chapters.

**Table 3.1. Programming codes**

<b>111</b>	external door station address
<b>112</b>	first button address ( <b>Pn</b> of <b>VD2121CAG</b> or <b>AD2121CAG</b> door station)
<b>113</b>	address of first button of first Additional Push-button Panel ( <b>Pn</b> of the first <b>AG100TS</b> )
<b>114</b>	door lock activation time
<b>116</b>	operation with door keeper exchangers
<b>121</b>	system programming (see table 3.2)
<b>210</b>	programming of call button with camera deactivation during the call
<b>211</b>	button reset with camera deactivation during the call
<b>233</b>	programming the buttons with special functions
<b>000</b>	back to factory settings

## Programming procedure

To make the programming it necessary to:

- enter the programming mode** following the instructions described in “*Entering the programming mode*”;
- enter the three digits of the programming code you want to change** following the instructions contained in “*Entering codes or address*”; **press PN to confirm**: you hear the confirmation tone and the red LEDs start flashing.
- make the operations described in the specific programming chapter.**
- continue** with another programming operation or exit moving the jumper **J1** from 2-3 to 1-2.

## Entering the External Door Station address (code 111)

In this mode you can code the external door station address with codes from 231 to 250.

- **Enter the programming mode** following the instructions described in “*Entering the programming mode*”;

- Enter code **111** and press **Pn**; you hear a confirmation tone and the red LEDs start flashing.
- Dial the code number you have chosen for the external door station and press **Pn** to confirm; you hear the confirmation tone and the red LEDs go back ON without flashing.
- Continue by entering the code of a new programming or exit the programming mode by moving the jumper **J1** to position **1-2**.

## Entering the First Button address (code 112)

The **VD2121CAG** (or **AD2121CAG**) board has 2 buttons: **PN** and **P1**. **PN** is the first button and **P1** takes the next value (i.e.: **Pn** = 001, **P1** = 002; **Pn** = 058, **P1** = 059).

The first button (**Pn**) is coded by default with address 100; if you want to change it, you must:

- **enter the programming mode** following the instructions described in “*Entering the programming mode*”;
- enter code **112** and press **Pn**; you hear a confirmation tone and the red LEDs start flashing;
- dial the address you want to assign to **Pn**. Extensions must be coded with numbers from 001 to 200;
- press **Pn**; you hear a confirmation tone and the red LEDs go back ON without flashing;
- continue by entering the code of a new programming or exit the programming mode by moving the jumper **J1** to position **1-2**.

## Entering the address of the First Button of the first additional push-button panel (code 113).

To increase the number of calls, you must integrate the **VD2121CAG** (or **AD2121CAG**) external station with one or more additional **AG100TS** push-button panels (max. 16). Each additional push-button panel must be coded with the 4 microswitches provided on the board (see instructions attached to the product). Moreover, an address must be assigned to the first button of the first additional push-button panel. The next buttons of all the additional push-button panels will automatically take progressive numbers. This address must be higher than the address of the **P1** button of the **VD2121CAG** (or **AD2121CAG**) external door station. The first button (**Pn**) of the first additional **AG100TS** push-button panel is coded by default with address 102; if you want to change it, you must:

- **enter the programming mode** following the instructions described in “*Entering the programming mode*”;
- enter code **113** and press **Pn**; you hear a confirmation tone and the red LEDs start flashing;
- dial the address you want to assign to the **Pn** button of the first additional push-button panel. Addresses must be numbers from 001 and 200; remember that addresses 100 and 101 are assigned to the 2 **VD2121CAG** (or **AD2121CAG**) buttons by default;

- continue by entering the code of a new programming or exit the programming mode by moving the jumper **J1** to position **1-2**.

## Lock actuation time (code 114). To change the lock actuation time, you must:

- **enter the programming mode** following the instructions described in “*Entering the programming mode*”;
- enter code **114** and press **Pn**; you hear a confirmation tone and the red LEDs start flashing;
- dial the number of seconds you want the door lock to stay ON (3 digits from 000 to 120);
- press **Pn**; you hear a confirmation tone and the red LEDs go back ON without flashing;
- continue by entering the code of a new programming or exit the programming mode by moving the jumper **J1** to position **1-2**.

## Operations with main or secondary door keeper exchangers (code 116).

The following settings are necessary if in the system are installed main and/or secondary door keeper exchangers.

To make the programming you must:

- **enter the programming mode** following the instructions described in “*Entering the programming mode*”;
- enter code **116** and press **Pn**; you hear a confirmation tone and the red LEDs start flashing;
- enter address **201** if the door station operates with 1 or more main door keeper exchangers or address **210** if the door station operates with 1 or more secondary door keeper exchangers;
- press **Pn**; you hear a confirmation tone and the red LEDs go back ON without flashing;
- continue by entering the code of a new programming or exit the programming mode by moving the jumper **J1** to position **1-2**.

## System programming (code 121)

This programming is used to activate or deactivate the functions listed in table 3.2 on page 3.9.

To make the programming you must:

- **enter the programming mode** following the instructions described in “*Entering the programming mode*”;
- enter code **121** and press **Pn**; you hear the confirmation tone and the red LEDs flash once every second to indicate that you are programming mode 1;
- **a** - press “**P1**” to activate/deactivate mode 1; a low tone indicates deactivation, and a high tone indicates activation;
- **b** - press “**Pn**” to confirm and go to the next programming; you hear a confirmation tone and the red LEDs generate a series of flashings to indicate the number of the next mode; if you do not need to change one or more operation modes, press “**Pn**” to go to the next modes;
- repeat actions **a** and **b** to programme all modes 2, 3 and 4;
- after programming and confirming mode 5 with “**Pn**”, press “**Pn**” three more times to exit the system programming mode; you hear a confirmation tone and the red LEDs go back on without flashing.

**Note.** The programming is not saved until all operation modes are confirmed.

- continue by entering the code of a new programming or exit the programming mode by moving the jumper **J1** to position **1-2**.

### Programming the buttons with camera deactivation during the call (code 210).

Using the AD2121CAG external station any additional external camera is not activated. This programming is used to set the buttons for which the camera must not be activated upon pressing (first operation mode **5** must be enabled in the system programming - code 121).

To make the programming you must:

- enter the programming mode following the instructions described in "Entering the programming mode";
- enter code **210** and press **Pn**; you hear a confirmation tone and the red LEDs start flashing;
- press, one at a time, all the buttons for which the camera must not be activated upon pressing;
- exit the programming mode moving the jumper **J1** to position **1-2**.

### Resetting the buttons with camera deactivation during the call (code 211).

To reset the camera activation function during the call for the buttons for which this function was deactivated with the previous programming operation (code **210**), you must:

- enter the programming mode following the instructions described in "Entering the programming mode";
- enter code **211** and press **Pn**; you hear a confirmation tone and the red LEDs start flashing;
- press, one at a time, the buttons for which you want to restore the camera activation function during the call; you hear a confirmation tone;
- exit the programming mode moving the jumper **J1** to position **1-2**.

### Managing the Special Buttons (code 233)

You can change the address that has been automatically assigned during the programming of the external door stations (see codes **112** and **113**) for a maximum number of 20 buttons. This function is useful if you want to change the progressive sequence of some calls and/or if you want to activate actuators for special functions.

To make the programming you must:

- enter the programming mode following the instructions described in "Entering the programming mode";
- enter code **233** and press **Pn**; you hear a confirmation tone and the red LEDs start flashing;
- **a** - dial the address of the extension (codes from 001 to 200) or the address actuator (codes from 211 to 220) following the instructions contained in "entering codes or addresses";
- **b** - keep pressed the button to which you want to assign the address that has been entered previously until you hear the confirmation tone;
- repeat operations **a** and **b** to programme other buttons or exit moving the jumper **J1** to position **1-2**.

### Resetting Special Buttons (code 233)

To reset one or more special buttons with the address that has been automatically assigned during the programming of the external door stations (see codes **112** and **113**), you must:

- enter the programming mode following the instructions described in "Entering the programming mode";
- enter code **233** and press **Pn**; you hear a confirmation tone and the red LEDs start flashing;
- **a** - keep pressed the button you want to reset until you hear the confirmation tone;
- repeat operation **a** to reset other buttons or exit moving the jumper **J1** to position **1-2**.

### Resetting default settings

After you have entered the programming mode as described in the corresponding chapter, you must:

- dial **000** following the instructions contained in "entering codes or addresses";
- press **Pn**; you hear a confirmation tone and the red LEDs start flashing;
- dial **123** following the instructions contained in "entering codes or addresses";
- press **Pn**; you hear a confirmation tone and the white LEDs of the camera start flashing;
- exit the programming mode moving the jumper **J1** from 2-3 to position **1-2**.

**Warning.** After you have carried out this procedure all programming settings will be reset to the default values.

## CODING THE AG100TS PUSH-BUTTON PANEL

The AG100TS and AGL100TS push-button panels must be coded to assign a progressive numbering to the buttons, therefore it is necessary to assign to each push-button panel its own row number setting correctly the microswitches **SW1**.

By default the push-button panels are coded with row number **1** (code recommended for the first additional push-button panel); change the row number of the next push-button panels by setting the microswitches **SW1** as indicated in the previous page table.

To assign the address of the first button of the first additional push-button panel you must follow the programming instructions of the VD2121CAG or AD2121CAG encoder (programming code 113).

### Notes:

- Do not use row number 0 (zero) since it is reserved for the VD2121CAG or AD2121CAG external door station.
- Each additional push-button panel must have a different row number.
- To have a progressive numbering of the buttons you must assign progressive row numbers (1, 2, 3, etc.).
- The numbers of any buttons not installed in the plate will not be used.

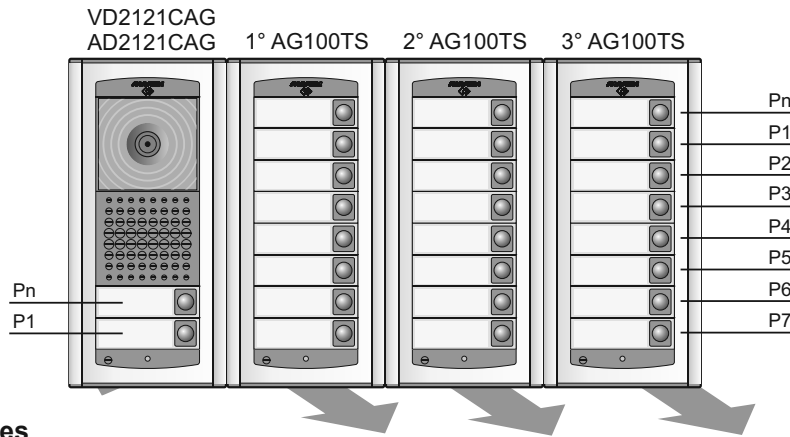
Table 3.2 - System programming (code 121)				Example of coding of addresses				
Operation modes	Default settings	Press button "P1"		Codes	Addresses Values from/to			
		high tone	low tone					
mode 1 activate conversation upon call	enabled	enabled <input type="checkbox"/>	disabled <input type="checkbox"/>	111	<table border="1"><tr><td>2</td><td>3</td><td>1</td></tr></table> 231 ÷ 250	2	3	1
2	3	1						
mode 2 tone activation	enabled	enabled <input type="checkbox"/>	disabled <input type="checkbox"/>	112	<table border="1"><tr><td>1</td><td>0</td><td>0</td></tr></table> 001 ÷ 200	1	0	0
1	0	0						
mode 3 video switch-on activation (*)	enabled (**)	enabled <input type="checkbox"/>	disabled <input type="checkbox"/>	113	<table border="1"><tr><td>0</td><td>0</td><td>3</td></tr></table> 001 ÷ 200	0	0	3
0	0	3						
mode 4 presence of second camera (**)	disabled	enabled <input type="checkbox"/>	disabled <input type="checkbox"/>	114	<table border="1"><tr><td>1</td><td>2</td><td>0</td></tr></table> 000 ÷ 120	1	2	0
1	2	0						
mode 5 activation / management of buttons with camera deactivation	disabled	enabled <input type="checkbox"/>	disabled <input type="checkbox"/>	121	see table 3.2			
mode 6 reserved; leave deactivated	disabled	-	disabled <input type="checkbox"/>					
mode 7 reserved; leave deactivated	disabled	-	disabled <input type="checkbox"/>					
mode 8 reserved; leave deactivated	disabled	-	disabled <input type="checkbox"/>					

(\*) If the installation is only intercom system (without the presence of videointercoms) the function must be disabled.

(\*\*) With AD2121CAG leave disabled - factory mode 3 is disabled.

# DOOR STATIONS

## Example composition of door stations



## Coding the push-button panels

Row number	Microswitch position
0 (*)	
1	
2	
3	
4	
5	
6	
7	
8	
9	
10	
11	
12	
13	
14	
15	

## Address examples

VD2121CAG - VD2121CAGL AD2121CAG - AD2121CAGL		1° AG100TS AGL100TS	2° AG100TS AGL100TS	3° AG100TS AGL100TS	
Programming (code 112)	(Pn-P1)	Programming (code 113)	1	2	3
			(Pn÷P7)	(Pn÷P7)	(Pn÷P7)
001	1-2	003	3 ÷ 10	11 ÷ 18	19 ÷ 26
050	50-51	052	52 ÷ 59	60 ÷ 67	68 ÷ 75
100	100-101	102	102 ÷ 109	110 ÷ 117	118 ÷ 125
100	100-101	110	110 ÷ 117	118 ÷ 125	126 ÷ 133
125	125-126	127	127 ÷ 134	135 ÷ 142	143 ÷ 150

**Codes 112 and 113.** Access codes to programme the first button (Pn) of the external door stations. This setting is made from the VD2121CAG videointercom door station or AD2121CAG intercom door station.

**Pn-P1 and Pn+P7.** Addresses of internal users called from these buttons.

## OPERATION

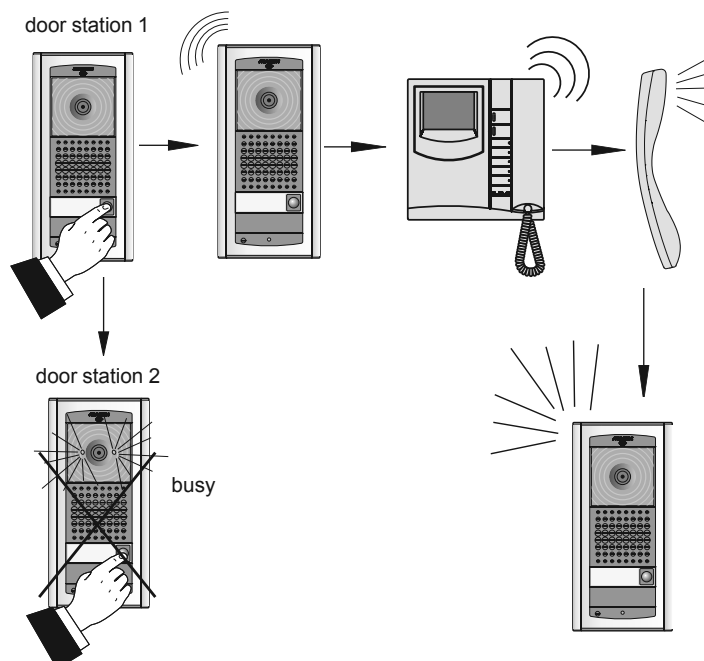
Check that all the connections of the system are correct. Connect the power supply unit to the mains. To make a call press the button corresponding to the desired user. Call is confirmed by an acknowledge tone, if the communication line is available, or denied by a busy tone and flashing red LEDs if the communication line is not available.

Called equipment rings only once, but if in this phase the same calling button on the external station is pressed again the equipment will ring another time.

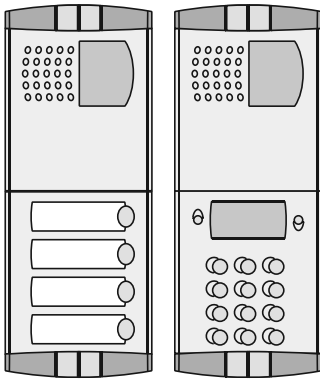
The called user picks up the handset and enables the conversation with the external station for 90 seconds. A tone will advise the user 10 seconds before the conversation ends. To continue conversation for additional 90 seconds on the external station the calling button must be pressed again.

Press the button to release the door lock. Door lock activation time depends to the choosing programming time (code 114).

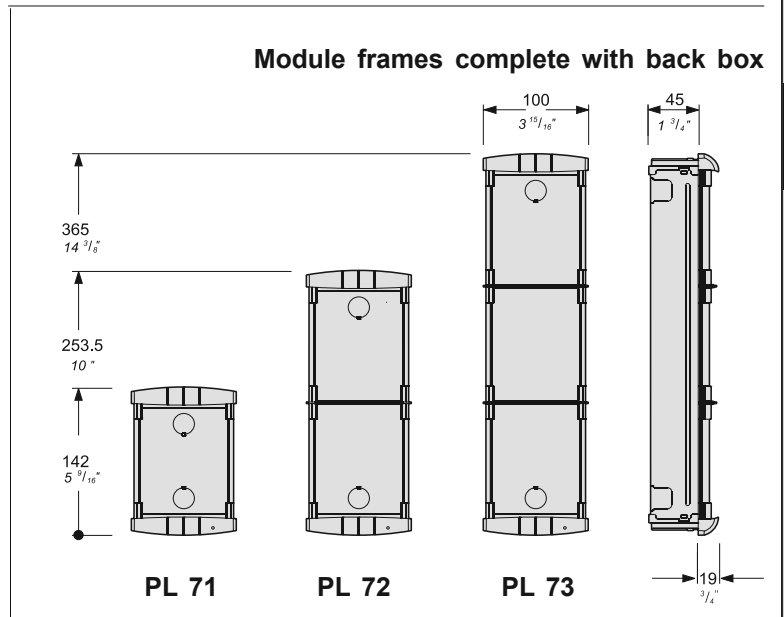
Replace the handset (or press for Zhero, myLogic and Echos) to end the conversation.



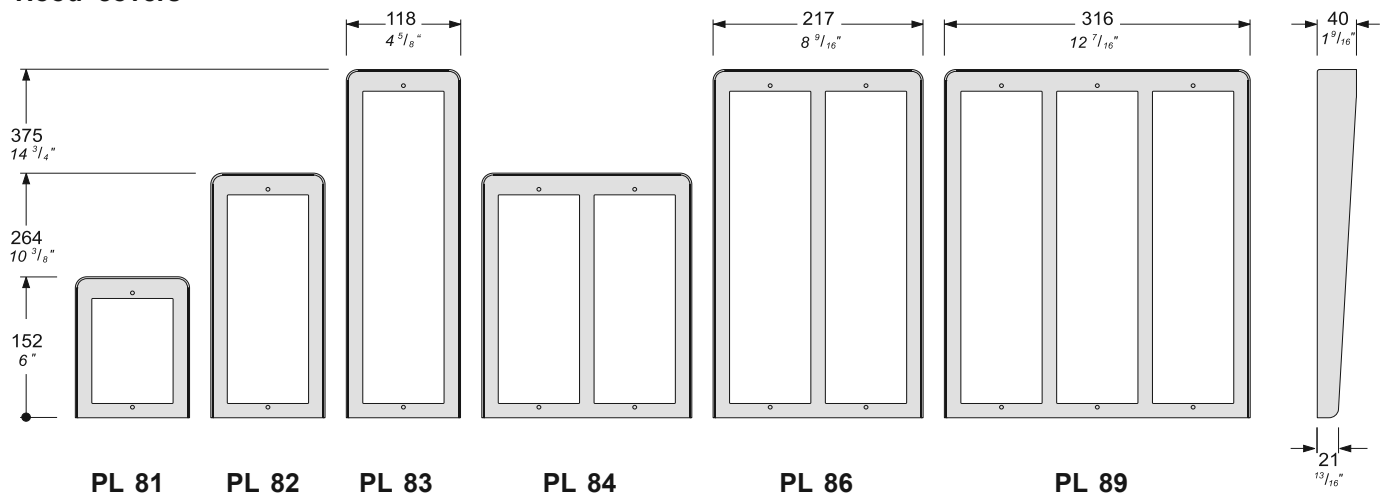
(\*) Do not use.  
Reserved for VD2121CAG, VD2121CAGL, AD2121CAG and AD2121CAGL



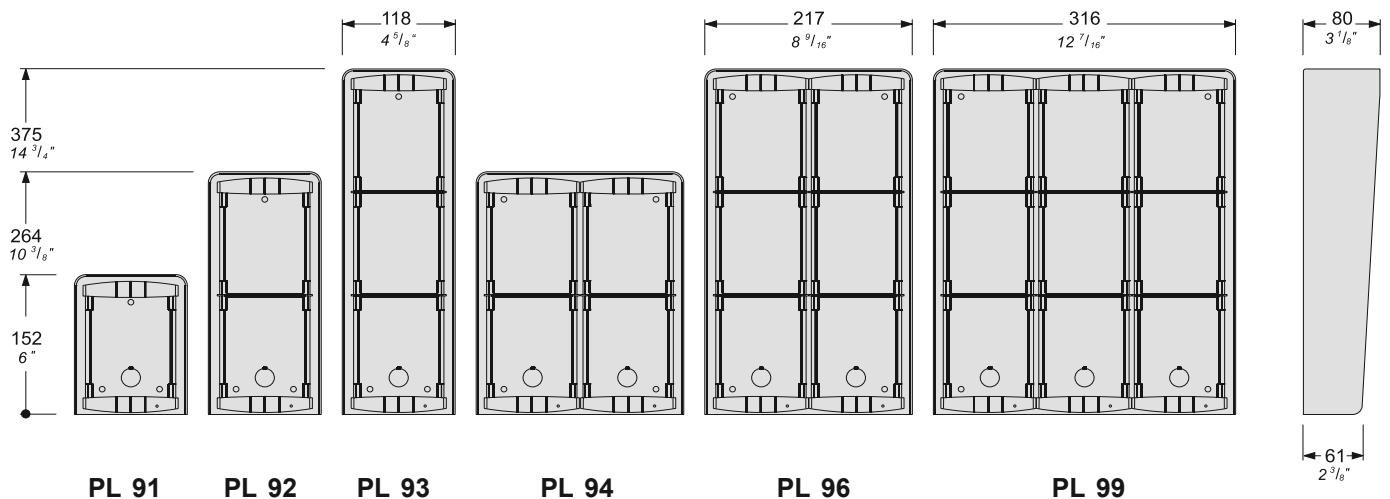
Push-button panels in extruded aluminium and steel push-buttons made up of modular elements. Suitable for the most diverse installation requirements. The careful selection of modules allows for multiple application opportunities; from one-way installations to blocks of flats; from intercom to video intercom installations. The optimized size of modules allows for easy installation on the gage jamb.



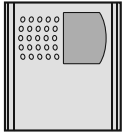
Hood covers



Rain shelters with module frames

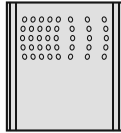


## Profilo modules



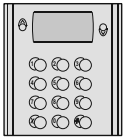
### VD2120CPL

colour camera with door speaker and auxiliary input for supplementary camera



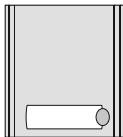
### AD2120CPL

door speaker with auxiliary input for camera



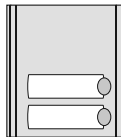
### TD2100PL

digital push-button with 14 buttons and alphanumerical LCD



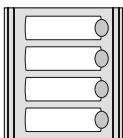
### CD2131PL

digitizer module with 1 call button



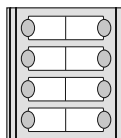
### CD2132PL

digitizer module with 2 call buttons



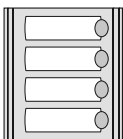
### CD2134PL

digitizer module with 4 call buttons



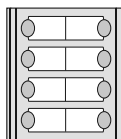
### CD2138PL

digitizer module with 8 call buttons (2 row)



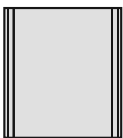
### PL 24S

module with 4 call buttons



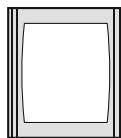
### PL 228S

module with 8 call buttons (2 row)



### PL 20

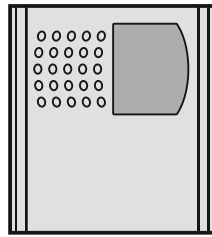
blank module



### PL 50

number module

## AUDIO-VIDEO MODULE



### VD2120CPL. Module complete with:

- CCD camera with autoiris, fixed 3.6mm lens and 6 white LED's
- amplified door speaker with reception and transmission volume and anti-feedback adjustments
- front plate with breakproof transparent screen
- horizontal and vertical adjustments
- red operation LED
- connection to the digital encoding modules (CD2131PL+CD2138PL) and digital door station (TD2100PL) through the cable complete with connectors supplied together with the items listed here above.

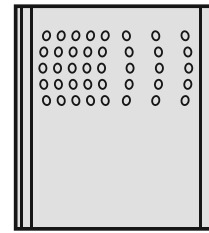
### Technical data

Power supply	13Vac±1
Absorption with connection to encoder CD2131+CD2138PL	0.8A
Video signal standard	PAL
Minimum illumination	2.5 Lux
Illumination system	6 (white)
Sensor	CCD 1/3" colour
Number of pixels	291,000
Lens	3.6mm
Focus	0.6m ± ∞
Horizontal/vertical adjustment	±15°
Operating temperature	-10°/+40°C
Max. permissible humidity	80%RH

### Terminals

- ~ / ~ 13VAC voltage input
- V Video signal input of a supplementary external camera (coaxial cable)
- M Video ground (coaxial shield)
- EC Positive signal for supplementary camera
- EM Negative signal for supplementary camera

## AUDIO MODULE



### AD2120CPL. Integrated door speaker module and input for external camera

Same terminals and features as model VD2120CPL, but without on-board camera.

In this module the EM and EC terminals are bridged by default.

### VD2120CPL and AD2120CPL audio adjustments

If necessary, you can adjust the volume of the 2 audio channels and the Larsen effect (feedback) with the relevant potentiometers.

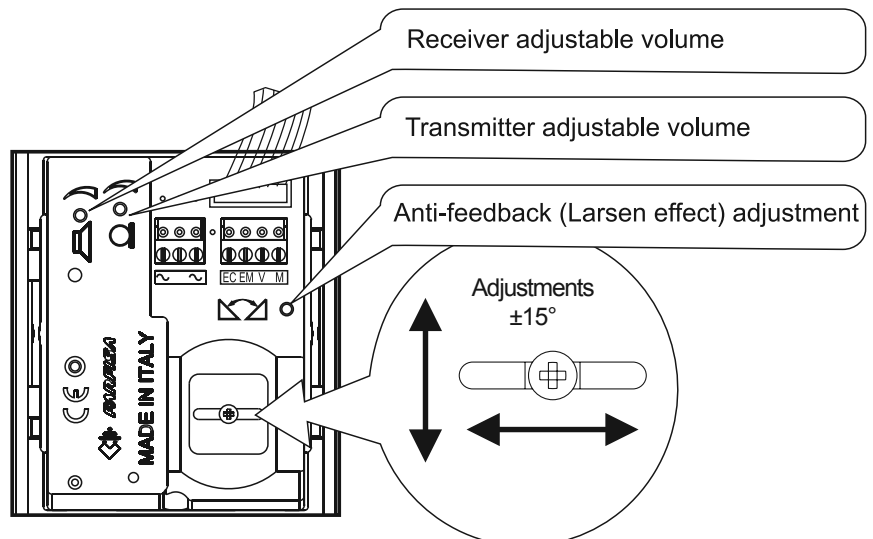
### Anti-feedback adjustment

In case of "feedback" (Larsen effect) in the external unit it is necessary to operate as follow:

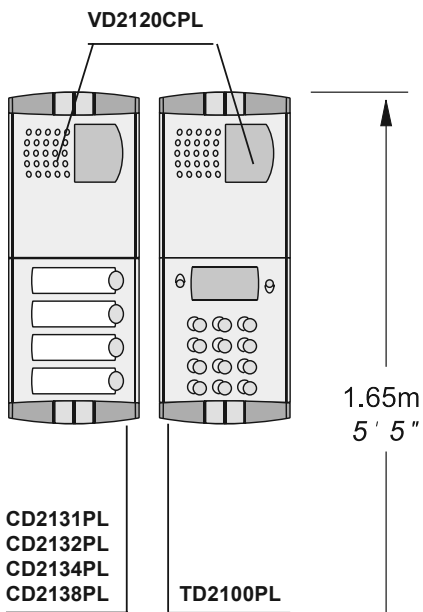
- make the call from the door station and lift the handset (press for Zhero, myLogic and Echos series) of the called user;
- adjust the trimmer until the whistling stops (Larsen effect).

### Adjustments

You can manually change the camera framing by unloosening and adjusting the horizontal and vertical screws in the desired direction.



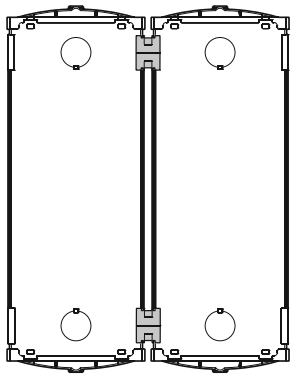
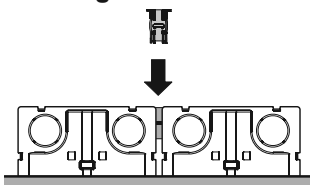
## INSTALLATION



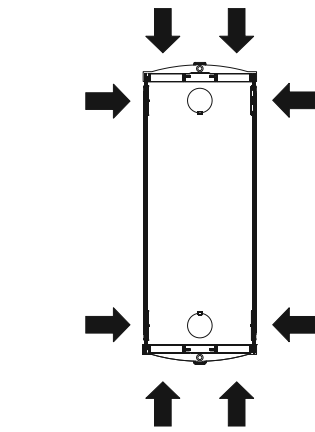
Place the push-button panel back box at a height of about 1.65m (5'5") from the floor keeping the front edges flush-mounted and vertical to the finished plaster.

**Position the camera in such a way that sunlight or other direct or reflected light sources with high intensity do not hit the camera lens.**

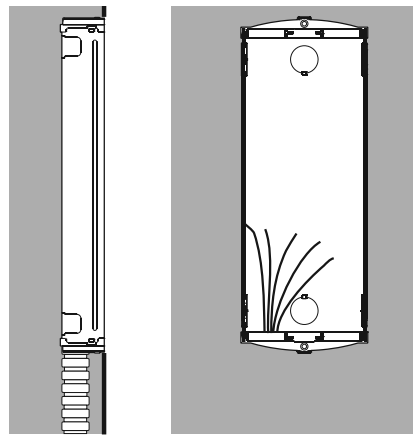
### Assembling modules side by side



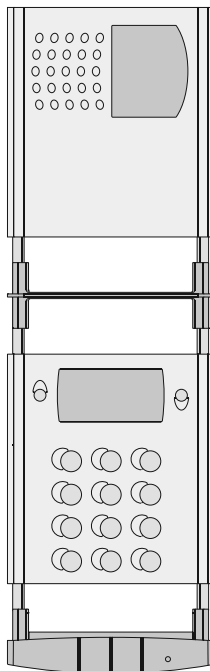
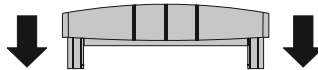
Insertion of spacers between back boxes. Spacers and cable bushing must be inserted before brick work.



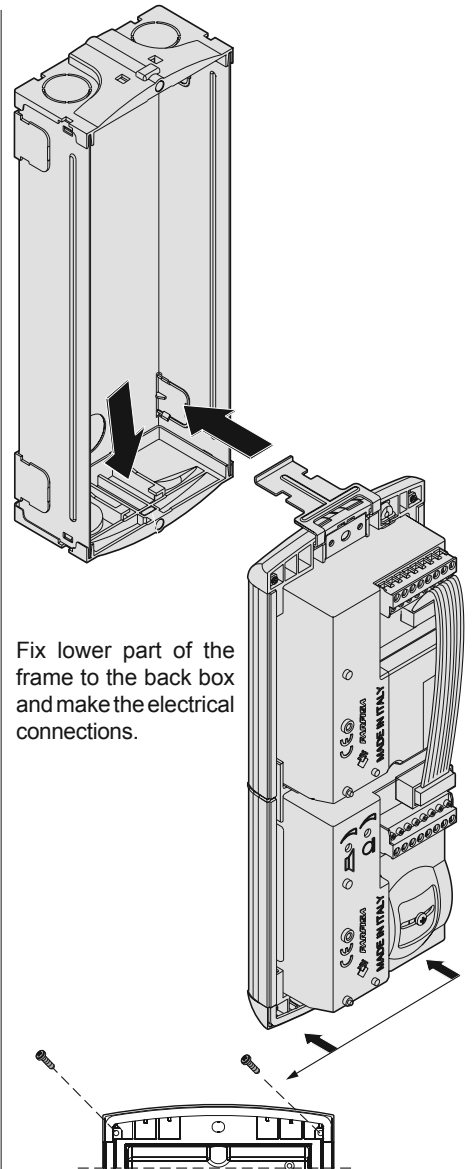
Openings for cables.



Flush mounting and cables placing.

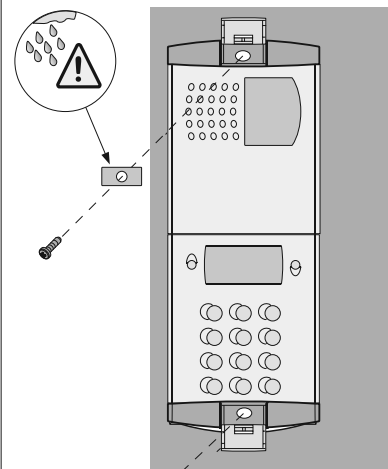


Mounting modules.



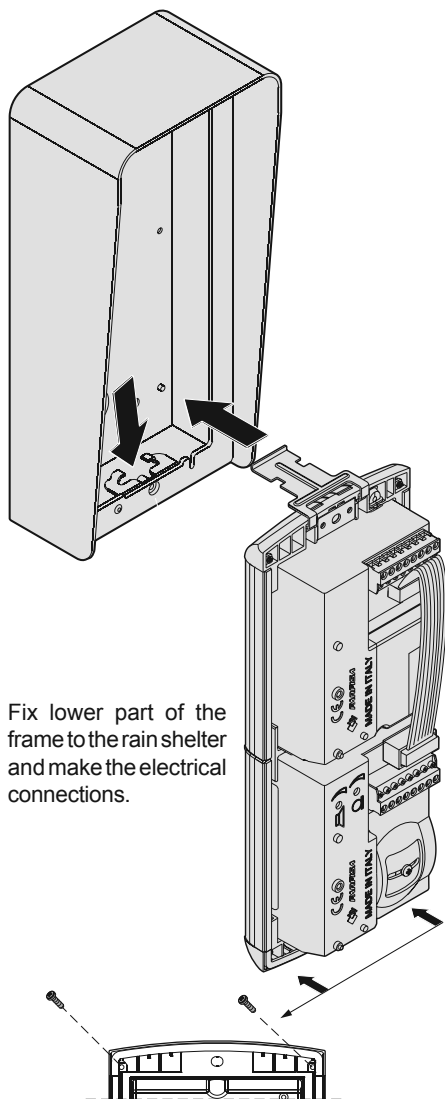
Fix lower part of the frame to the back box and make the electrical connections.

Fixing of the module frames on the upper side by the 2 small screws included in the back boxes.



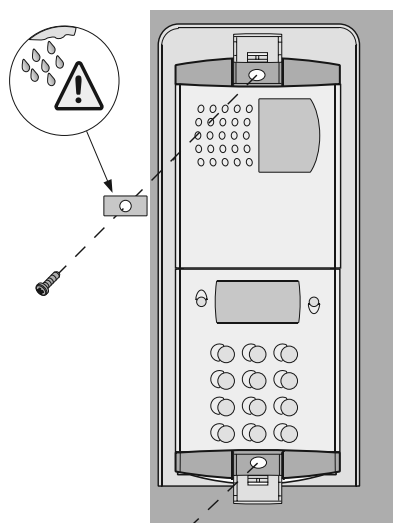
Fixing of frame to back box. Align the frame before tightening the screws.

## Rain shelter



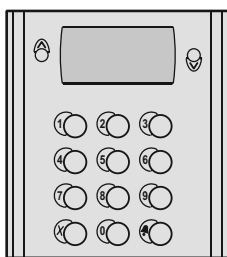
Fix lower part of the frame to the rain shelter and make the electrical connections.

Fixing of the module frames on the upper side by the 2 small screws included in the rain shelter.



Fixing of frame to rain shelter. Align the frame before tightening the screws.

## DIGITAL PUSH-BUTTON PANEL



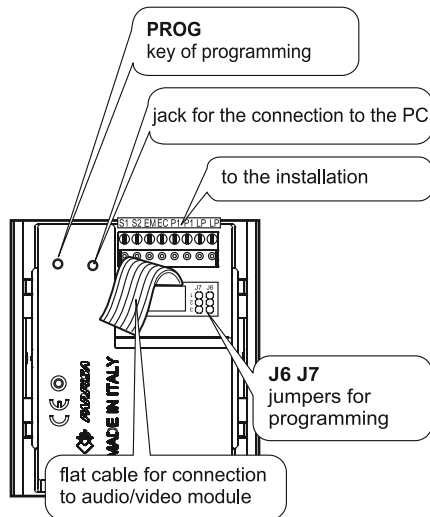
**TD2100PL.** Profilo series steel push-button panel with 14 buttons and alphanumerical LCD. Used to dial and send calls over DUO digital line.

### Technical features

Power supply from audio/video module	
Door-opening time	3/6 seconds
LCD	2 lines x 16 characters
Number of calls	200
Memory	250 names
Dimensions	1 module
Operating temperature	0°/+40°C
Maximum humidity acceptable	90% RH

### Terminals

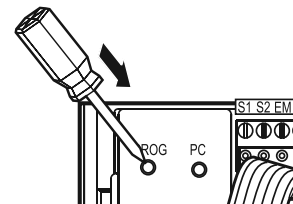
<b>LP/LP</b>	audio-data-video to and from internal users
<b>P1/P1</b>	direct call button inputs
<b>EC</b>	positive signal for auxiliary service
<b>EM</b>	negative signal for auxiliary service
<b>S1/S2</b>	door opening contacts



## PROGRAMMING

Before programming you must:

- Press the button **PROG** on the back of the push-button panel using a small screwdriver; the display shows "Programming / type: ".
- Dial the programming code (see table 3.3) and press to confirm.
- Once you have programmed each code, press the button **PROG** again; the display shows "FARFISA / dial the number or press or the text set during the programming phase (see "Personalisation of display initial text").



**Table 3.3**  
Programming codes

<b>00</b>	Entry of codes for door lock
<b>01</b>	Entry-modification-deletion of names
<b>02</b>	Language selection
<b>03</b>	System programming
<b>04</b>	Entry of display initial text
<b>05</b>	Loading names from PC
<b>06</b>	Ordering names
<b>10</b>	Address door station (PE)
<b>11</b>	Address button P1
<b>12</b>	Address associated with EC-EM terminals
<b>30</b>	Settings for operations with a doorkeeper exchanger

### Codes to deactivate the camera upon call of 2 user groups

<b>20</b>	First address in group 1
<b>21</b>	Last address in group 1
<b>22</b>	First address in group 2
<b>23</b>	Last address in group 2

### Entry of codes for door lock (code 00)

Enter the programming mode and insert code **00** to access the "entry of codes for door lock" mode; the display shows "PASSWORD 0 / ".

- Dial the first opening code on the keypad, for example 7890; the display shows "PASSWORD 0 / 7890".
- Press , the display shows "PASSWORD 1 / ".
- Dial the second opening code on the keypad, for example 1234; the display shows "PASSWORD 1 / 1234".
- Press , the display shows "PASSWORD 2 / ".
- Repeat the operations to insert max. 16 codes; when you press the button to confirm the sixteenth code (PASSWORD 15) the display shows "Programming / type: ".
- Continue by entering the code of a new programming function or press the button **PROG** to exit.



**Modifying a code**

To change the previously saved code you must enter the programming mode and then:

- select the programming code **00**;
- press the button until the code you want to modify is displayed;
- press **X** to go to the code you want to modify;
- enter the new code on the keyboard and then press the button ;
- repeat the operation for all the codes you want to modify;
- press the button **PROG** to exit the programming mode.

**Deleting a code**

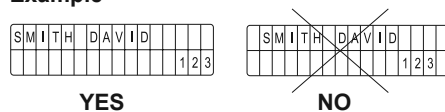
To delete the previously saved code you must enter the programming mode and then:

- select the programming code **00**;
- press the button until the code you want to delete is displayed;
- press the button **X** and then ;
- repeat the operation for all the codes you want to modify;
- press the button **PROG** to exit the programming mode.

**Entry / modification / deletion of names (code 01)**

The digital keyboard TD2100PL has an alphanumerical display with 32 characters that displays the user name and extension number (28 characters are used for user name and the last 4 characters on bottom right are used for extension number). To save them, you must follow the procedure illustrated below. The name must be entered starting from the first character on top left and the last digit of the extension number must be entered in the last position on bottom right, otherwise the number will not be saved (see “deletion of names”).

After you have entered all the names, the system will automatically arrange them in alphabetical order.

**Example****Function of buttons when entering or modifying a name**

- Hold this button pressed to scroll the list of existing names
- X** Hold this button pressed to move the cursor to the name characters
- Hold this button pressed to scroll down the list of characters
- Hold this button pressed to scroll up the list of characters

When searching for characters, the display shows uppercase letters, low-case letters, numbers, special characters and space in a sequence.

**Entry of names**

- Press the button **PROG** to enter the programming mode.
- Enter the code **01** and press the button ; the display shows the first name. The display is empty if no codes are programmed.
- Press or to select the character for the first cell; press **X** to go to the second cell; press or to select the character for the second cell; continue until you have entered the complete name with code. Press **X** after you have entered the number in the last cell on bottom right; the display shows “STORE USER / YES  $\wedge$  V NO”; press to confirm; press to modify the name.
- If confirmed, the display shows the second name. The display is empty if no names are programmed.
- Press the button **PROG** again to confirm the last name to insert. The display shows “waiting” and an automatic status bar. Normal operation is restored after a few seconds and the display shows the initial text (see “Operation” on page 3.17).

**Notes.** Once you have entered 250 names the display shows “waiting” and an automatic status bar. After a few seconds the display shows “Programming / type: “ and you can continue with programming or press the button **PROG** to exit.

You can enter 2 or more names with the same call number (i.e. different family names in the same apartment).

**Modification or correction of names**

- Press the button **PROG** to enter the programming mode.
- Enter the code **01** and press the button ; the display shows the first name.
- Press to search for the name you want to modify (hold the button pressed for quick searching).
- Press **X** to go to the character you want to modify.
- Select the character with (forward) (backward).
- Repeat the operation until you have completed the name modification.
- Once you have completed the modification, hold **X** pressed until the display shows “STORE USER / YES  $\wedge$  V NO”. Press to confirm or to modify the name again. Enter a space to delete a letter.

**Addition of 1 or more names to the list**

To add a new name to the existing list you must:

- press the button **PROG** to enter the programming mode;
- enter the code **01** and press the button ; the display shows the first name;
- press to scroll the list (hold the button pressed for quick searching); the display is empty after the last name;
- to enter a new name follow the operations described in “Entry of names”. If confirmed, the name is placed in the list in alphabetical order.

**Deletion of names**

- Press the button **PROG** to enter the programming mode.
- Enter the code **01** and press the button ; the display shows the first name.
- Press to search for the name you want to delete (hold the button pressed for quick searching).
- Press **X** to go to the last cell (bottom right); enter a space to delete the existing number.
- Press **X** again; the display shows “DELETE USER / YES  $\wedge$  V NO”. Press to confirm or to go back to the name. The next name is displayed after you have deleted the name.

**Language selection (code 02)**

You can choose the language from 8 different options (Italian, English, French, German, Spanish, Portuguese, Turkish and Polish) in operation mode.

To select the language:

- press the button **PROG** to enter the programming mode;
- enter the code **02** and press the button ; the display shows “Italiano” in case of first programming or the programmed language;
- press or to select the language.
- press to confirm; the display shows “Programming / type: “;
- continue by entering the code of a new programming function or press the button **PROG** to exit.

**System programming (code 03)**

You can change or activate the functions of the push-button panel (see table 3.4).

For programming you must:

- press the button **PROG** to enter the programming mode;
- enter the code **03** and press the button ; the display shows “bit 0 = 0 / 0  $\wedge$  V 1” in case of first programming or “bit 0 = 1 / 0  $\wedge$  V 1” if changed in the previous programming;
- press to select 0 or to select 1;
- press to confirm and go to the next code (see code table with descriptions);
- once you have confirmed the value of the last code (bit 7), the display shows “Programming / type: “;
- continue by entering the code of a new programming function or press the button **PROG** to exit.

**Personalisation of display initial text (code 04)**

You can modify the text shown on the display during normal operation or idle state. For visualization you must set bit 4 or bit 5 with value “1” (see “system programming”).

To insert a personalized text:

- press the button **PROG** to enter the programming mode;
- enter the code **04** and press the button ; the display shows “DUO System”, in case of first programming, or the text you want to replace;
- for information on how to enter the characters see “entry of names”;

Table 3.4 - System programming codes (code 03)

Programming code	Function description	Default settings	Value entered with buttons	
			☎ = 0	☎ = 1
bit 0	door lock activation time	3 sec.	3 seconds	6 seconds
bit 1	activation upon call from internal station (1)	YES	NO	YES
bit 2	door lock activation with $\chi$ (2)	NO	NO	YES
bit 3	deactivation of tone generator on the external door station	NO	NO	YES
bit 4	activation of personalised initial screen (3)	NO	NO	YES
bit 5	deactivation of FARFISA and activation of personalised text	NO	NO	YES
bit 6	EC-EM terminals for additional camera switching	NO	NO	YES
bit 7	activation time of the EC-EM terminals for supplementary lock	3 sec.	3 seconds	6 seconds

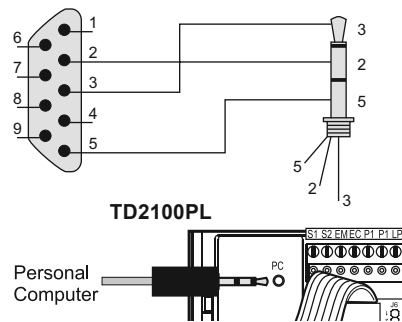
- 1) With this function, by pressing the ☎ button and lifting the handset up (or pressing  $\equiv$  in Zhero, Echos, myLogic models), you can start a conversation with an external door station from any internal station (in case of multiple external door stations in parallel a conversation can be started with the last external door station that has made the call) and activate the door lock by pressing the key  $\chi$ .
- (2) This functions allows for quicker door lock activation by pressing  $\chi$  rather than dialling the code 00+☎. For example: press  $\chi$  + password + ☎.
- (3) You can alternate "FARFISA" with the personalised text (see "personalisation of display initial text").

- press ☎ to confirm; the display shows "Programming / type: ";
- continue by entering the code of a new programming function or press the button PROG to exit.

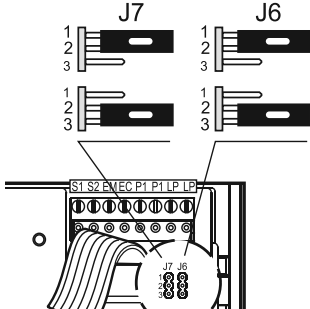
**Loading names from PC (code 05)**

You can load names directly from your PC.

- Load the names on the PC using a dedicated software application (software supplied on demand).
- Turn off the push-button panel and the PC.
- Connect the PC serial port to the stereo jack on the back of the push-button panel with a cable as shown in the figure.



- Move the jumpers J6 and J7 on the back of the push-button panel from 1-2 to 2-3.



- Turn on the PC and then the push-button panel.
  - Press the button PROG to enter the programming mode.
  - Enter the code 05 and press the button ☎; the display shows "TD2100PL ---- PC / in progress....0".
  - Download the names from the PC within 15 seconds; the display shows "TD2100PL --- -PC / in progress....1", "TD2100PL ---- PC / in progress....2" and then the downloaded names.
- At the end of download the push-button deletes the existing names. The first line of the display shows "waiting" and the second line shows a status bar to show the progress of the deletion operation. At the end the display shows "Programming / type: ".
- Turn off the push-button panel and then the PC.
  - Disconnect the cable from the PC and the push-button panel.
  - Bring the jumpers J6 and J7 back to 1-2.

**Ordering names (code 06)**

You can list the names in alphabetical order (from A to Z).

- Press the button PROG to enter the programming mode.
- Enter the code 06 and press the button ☎; the first line of the display shows "waiting" and the second line shows a status bar; at the end of the operation the push-button panel returns automatically to the programming mode (the display shows "Programming / type: ").
- Continue by entering the code of a new programming function or press the button PROG to exit.

**Inserting the external door station address PE (code 10)**

You can code the external door station address with codes from 231 to 250.

- Press the button PROG to enter the programming mode.
- Enter the code 10 and press the button ☎; the display shows "ADDRESS PE".

- Dial the coding number for the door station and press the button ☎ to confirm.
- Continue by entering the code of a new programming function or press the button PROG to exit.

**Inserting the button address P1 (code 11)**

To save an extension number and call it directly from a button connected between terminals P1/P1:

- press the button PROG to enter the programming mode;
- enter the code 11 and press the button ☎; the display shows "ADDRESS P1";
- dial the extension number. Extensions must be coded with numbers from 001 to 200;
- press the button ☎ to confirm;
- continue by entering the code of a new programming function or press the button PROG to exit.

**How to enter the address of EC-EM terminals (code 12)**

- press the button PROG to enter the programming mode;
- enter code 12 and press the button ☎; the display shows "ADDRESS EC";
- dial the number of the desired address (255 for relay or camera activation mode; 250 for door lock mode; number of internal station before the first user of the supplementary door lock service);
- press the button ☎ to confirm programming;
- press the button PROG to exit the programming mode.

**Operations whit door keeper exchangers (code 30)**

Following settings are necessary if in the system are installed main and/or secondary door keeper exchangers.

- Press the button PROG to enter the programming mode.
- Enter the code 30 and press the button ☎; the display shows "ADDRESS PDX".
- Enter address 201 if the door station operates with 1 or more main door keeper exchangers or address 210 if the door station operates with 1 or more secondary door keeper exchangers.
- Press the button ☎ to confirm.
- Press the button PROG to exit the programming mode.

**Return to operation mode**

Press the button **PROG** at the end of programming; the display shows "FARFISA / dial the number or press ^v" or the text you have entered during programming (see "Personalisation of display initial text").

**EC-EM TERMINALS**

The EC-EM terminals can be used to connect:

- one active relay during the call and for the entire conversation (default)
- one additional camera
- one additional door lock

To have these functions you must connect the terminals correctly and make some programming operations on the TD2100PL push-button panel.

**- Connection of one relay (see fig. 1)**

Programming operations to be made:

- code **03** = set **bit 6** at **0**
- code **03** = set **bit 7** at **0**
- code **12** = enter address **255**

**- Connection of one additional camera**

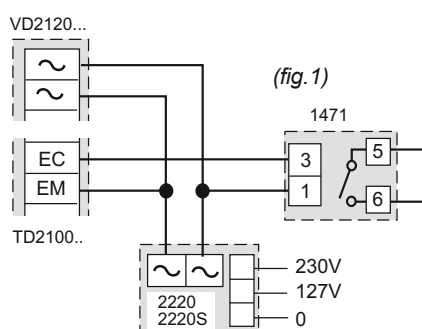
For this use you must connect the EC and EM terminals to the corresponding terminals of the audio/video module (see diagrams si51VM/32 and si51VM/169 on chapter 5).

Programming operations to be made:

- code **03** = set **bit 6** at **1**
- code **03** = set **bit 7** at **0**
- code **12** = enter address **255**

**- Connection of one additional door lock.**

For this use you must connect a relay as shown in the figure and program the push-button panel according to the desired service. The presence of the additional door lock requires to change the password (code 00). The first 8 passwords will activate the door lock connected to terminals S1 and S2, and the remaining 8 passwords will activate the door lock connected to terminals EC and EM.



**1) - activation of door lock from turn-on button of internal stations** (☉ or ☎ from videointercoms; ● from intercoms). This function can be activated only during a conversation with the external door station. In idle state the buttons will activate the external door station.

Programming operations to be made:

- code **03** = set **bit 6** at **0**
- code **03** = set **bit 7** at **0** (3 seconds) or **1** (6 seconds)
- code **12** = enter address **250**

**2) - activation of door lock from button of internal stations**

This programming allows for having two groups of users connected to a single external door station, each of them with its own door lock. The division between the two groups is indicated by the number that is inserted in the programming of code **12** (see page 3.16). You must insert the last user number recognised by group 1 that will activate the door lock connected to terminals S1 and S2; all higher numbers will automatically be in group 2 and will activate the door lock connected to terminals EC and EM.

Programming operations to be made:

- code **03** = set **bit 6** at **0**
- code **03** = set **bit 7** at **0** (3 seconds) or **1** (6 seconds)
- code **12** = insert address of **last user in group 1** (example: if you enter 99 you will have: group 1 with codes from 1 to 99; group 2 from 100 to 200).

**How to deactivate the camera upon call**

You can create 2 groups of user addresses that will not activate the camera during the call from the external door station. This function is used to avoid the temporary turn-on of white LEDs in the colour camera module during calls to intercoms or actuators 2281.

**How to set address groups (codes 20, 21, 22 and 23)**

- press the button **PROG** to enter the programming mode;
- enter code **20** and press the button ☎; the display shows "ADDRESS 1S";
- dial the address number of first user in group 1;
- press the button ☎ to confirm programming;
- enter code **21** and press the button ☎; the display shows "ADDRESS 1E";
- dial the address number of the last user in group 1;
- press the button ☎ to confirm programming;
- repeat the operations above to enter the address of the first and last user in group 2 (codes **22** and **23**, respectively);
- press the button **PROG** to exit the programming mode.

**DISPLAY SETTINGS**

You can adjust the display contrast and background colour with the buttons of the push-button panel.

**Contrast**

- dial **0090**; the display shows "press ^ or v" with a state bar;
- within 5 seconds press the buttons ☎ and ☎ to increase or decrease the display contrast;
- press the button ☎ to save.

**Background colour**

- dial **0091**; the display shows "press ^ or v" with a state bar;
- press the buttons ☎ and ☎ to select the colour;
- press the button ☎ to save.

**OPERATION**

Check that all connections are correct. Connect the power supply unit to the mains; the displays shows for 3 seconds "FARFISA", followed by the software version of the push-button panel and "Dial the number or press ^v (^v in alternate mode).

Dial the user number or select the internal station from the names in the list (press ☎ or ☎ to search), to verify its exactness on the display and press ☎ to make the call.

In case of error press X (only before sending the call) and dial the correct to number.

If the line is free and the called number exists you hear the confirmation tone and the display shows "Calling / ----" otherwise you hear the busy tone and the display shows "Busy /".

If press X the call is terminated and the system is ready for a new call.

The called user picks up the handset (or press ☎ for Zhero, myLogic and Echos series) enables the conversation with the external station for 90 seconds. The display shows "Connection / ----".

The text on the display starts flashing 10 seconds before conversation ends. To continue conversation for additional 90 seconds press ☎ again.

Press the ☎ button to release the door lock. Door lock activation time is 3 seconds (or 6 seconds).

Replace the handset (or press ☎ for Zhero, myLogic and Echos series) or press X on the door station to restore the idle state.

Numbers that are not sent or deleted go off after 25 seconds.

**Door lock opening**

The door lock can be opened from the push-button panel, including in "busy" mode, by dialling one of the 16 4-digit codes you have entered.

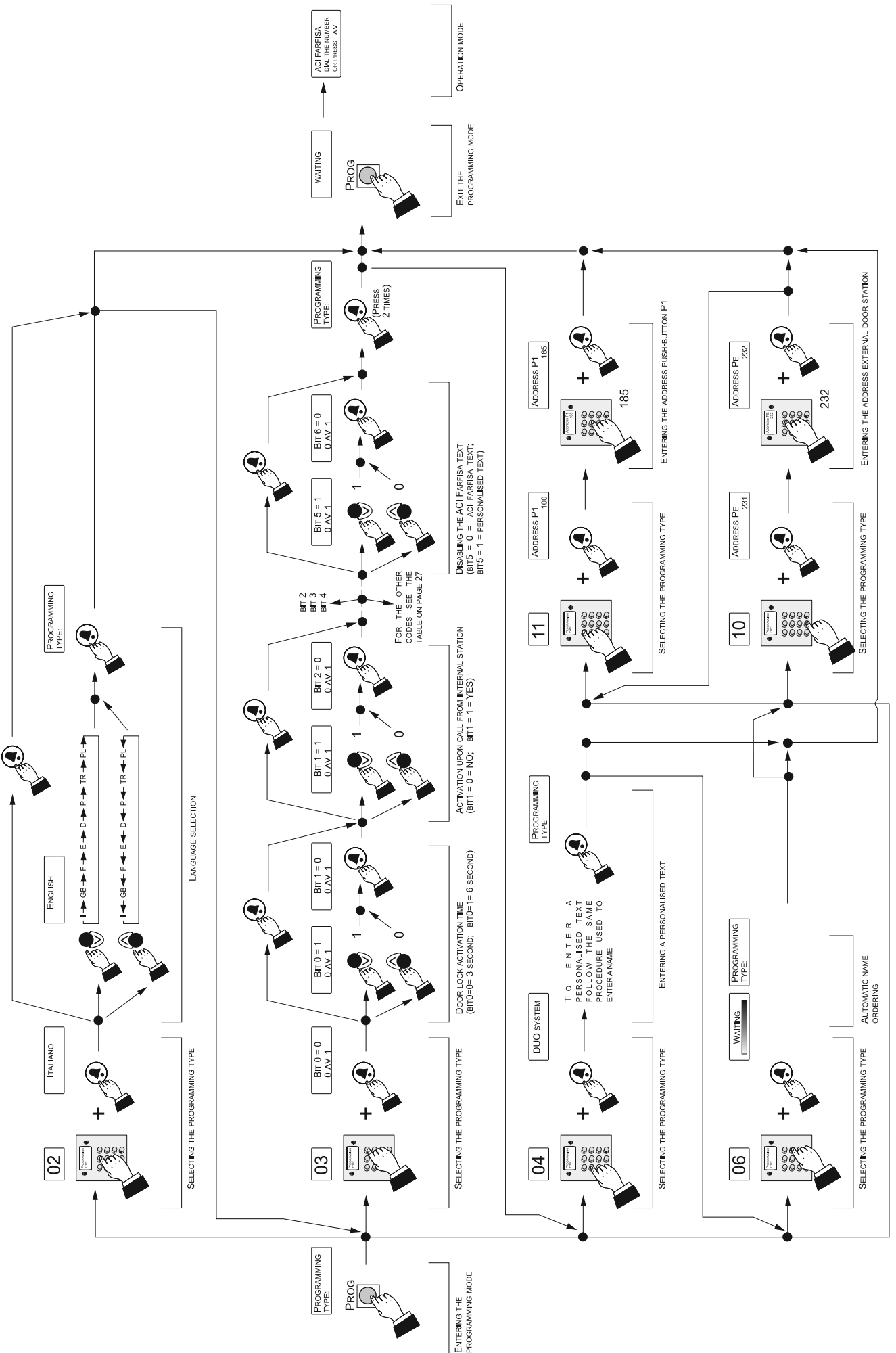
**Door lock activation**

- Dial **00**
- Press ☎; the display shows "Password / ■■ ■■"
- Dial the personal access code within 10 seconds; each digit is visualised with \* instead of ■.
- Press ☎ to release the door lock; you hear the confirmation tone and the push-button panel returns to the current system operation mode (free or busy).

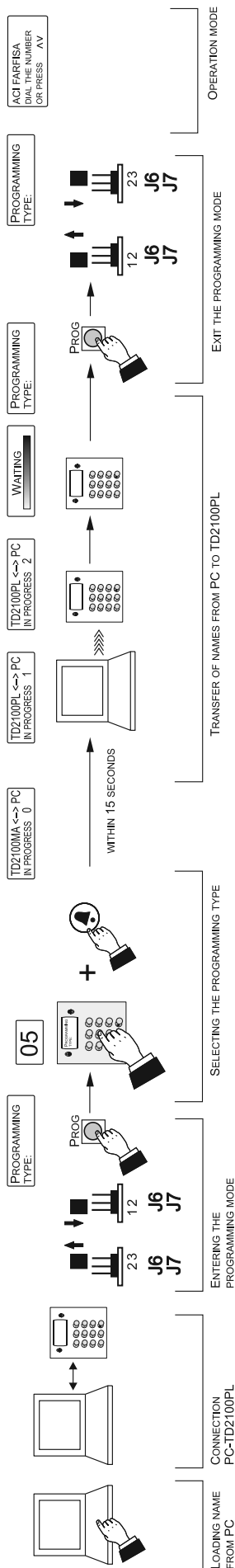
**Tone table.** See page 3.40.



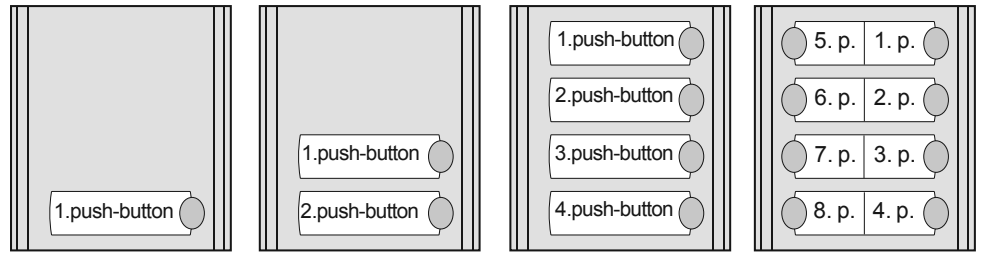
02 - Language selection Code 03 - System programming Code 04 - Personalisation of display initial text Code 06 - Ordering names  
 Code 10 - Entering address door station Code 11 - Entering address push-button P1



Code 05 - Loading names from Personal Computer



DIGITAL ENCODER



**CD2131PL.** Encoding module with front plate and one aluminium button. Complete with name-holders with transparent screen green back-lighting, breaking resistant. Used to send calls over DUO digital line.

**CD2132PL.** With 2 call buttons.

**CD2134PL.** With 4 call buttons.

**CD2138PL.** Same as the previous, but with 8 call buttons on two rows.

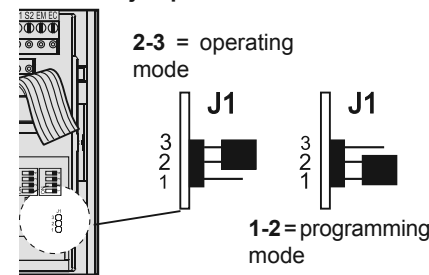
**Technical features**

Power supply from audio/video module	
Door-opening time	3/6 sec.
Number of calls	128
Default address	231
Address 1 <sup>st</sup> push-button (default)	100
Dimensions	1 module
Operating temperature	0°+40°C
Maximum humidity acceptable	90% RH

**Terminals**

- LP/LP** audio-data-video to and from internal users
- EC** positive signal for auxiliary service
- EM** negative signal for auxiliary service
- S1/S2** door opening contacts

**Position of jumper J1**



**PROGRAMING**

(instruction for article with software **AF100** or higher)

To program the device it is necessary to perform the following phases:

- 1) enter programming mode
- 2) insert code of desired programming
- 3) insert required address or functional code
- 4) exit programming mode

**Notes**

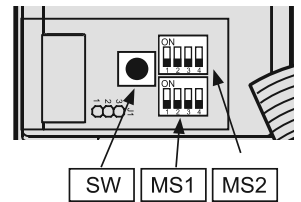
- In any situation it would be possible to exit the programming phase following the instructions reported on paragraph 4.

**1) Enter programming mode**

- Move the jumper **J1** from 2-3 to 1-2 position; a programming tone will confirm the correct operation.

**2) Insert code of desired programming**

- On the micro-switches **MS1** and **MS2** set the code corresponding to the programming operation you wish to enter as reported on table 3.5 on page 3.21 (codes **1A**, **2A**, **1B**, **2B** and **AA**).

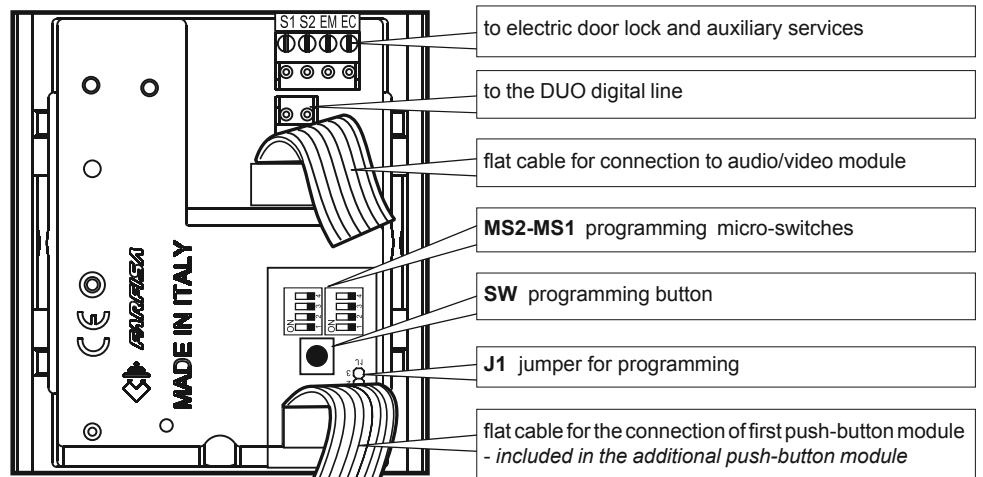


- Press the programming button **SW**.

**3) Insert required address or functional code**

- On the microswitches **MS1** and **MS2** set the address you wish to enter in accordance with the cross-references reported on table 3.7 on the pages 3.23, 3.24 and 3.25. For system programming see table 3.6 on the page 3.22 (code **2B**).

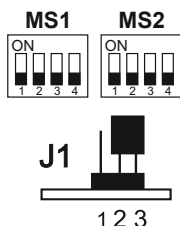
**Connection terminal boards**



- Press the programming button **SW**.
- Repeat phases 2 and 3 until you have completely programmed the digital encoder.
- Any time you press the **SW** button an acknowledge or error tone will warning you whether the entered code is correct or not; in case of incorrect code you must enter again the correct one.

**4) Exit programming mode**

To exit the programming phase it is necessary to set OFF all the microswitches **MS1** and **MS2** and move back the jumper **J1** from 1-2 to 2-3 position.



**EC-EM TERMINALS**

The EC-EM terminals can be used to connect:

- one active relay during the call and for the entire conversation (default)
  - one additional camera
  - one additional door lock
- To have these functions you must connect the terminals correctly and make some programming operations on the push-button panel.

● **Connection of one relay** (see fig. 1)

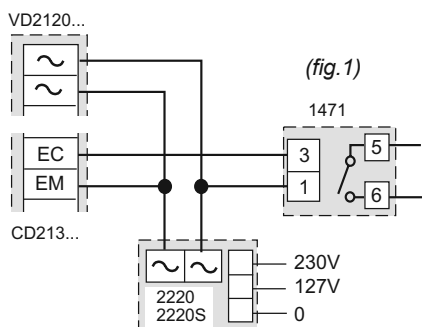
- Programming operations to be made:
- microswitch **3** of **MS2** = position **OFF**
  - microswitch **4** of **MS2** = position **OFF**
  - code **1E** = enter address **255**

● **Connection of one additional camera**

- For this use you must connect the EC and EM terminals to the corresponding terminals of the audio/video module.
- Programming operations to be made:
- microswitch **3** of **MS2** = position **ON**
  - microswitch **4** of **MS2** = position **OFF**
  - code **1E** = enter address **255**

● **Connection of one additional door lock.**

For this use you must connect a relay as shown in the figure and program the push-button panel according to the desired service.



- 1) - activation of door lock from turn-on button of internal stations** (☉ or ☽ from videointercoms; ● from intercoms). This function can be activated only during a conversation with the external door station. In idle state the buttons will activate the external door station.
- Programming operations to be made:
- microswitch **3** of **MS2** = position **OFF**
  - microswitch **4** of **MS2** = position **OFF** (3 seconds) or **ON** (6 seconds)
  - code **1E** = enter address **250**

- 2) - activation of door lock from button ● of internal stations**
- This programming allows for having two groups of users connected to a single external door station, each of them with its own door lock. The division between the two groups is indicated by the number that is inserted in the programming of code **1E**. You must insert the last user number recognised by group 1 that will activate the door lock connected to terminals S1 and S2; all higher numbers will automatically be in group 2 and will activate the door lock connected to terminals EC and EM.

**Table 3.5**

**Selection code of the programming**

**Address or function to be programmed**

<b>1A</b>		User address associated to the first button. Codes from 1 to 200 (see table 3.7 of pages 3.23, 3.24 and 3.25). Factory setting 100.
<b>2A*</b>		User address associated to the last button. Codes from 1 to 200 (see table 3.7 of pages 3.23, 3.24 and 3.25). Factory setting 200.
<b>1B</b>		Address of the external door station. Codes from 231 to 250 (see table 3.7 of page 3.25). Factory setting 231.
<b>2B</b>		System programming (see table 3.6 of page 3.22).
<b>1C</b>		Settings for operations with a doorkeeper exchanger. Enter address <b>201</b> if the door station operates with 1 or more main door keeper exchangers or the address <b>210</b> if the door station operates with 1 or more secondary doorkeeper exchangers (see table 3.7 of page 3.25).
<b>1E</b>		Address associated with terminals EC-EM (see corresponding section for codes to be inserted).
<b>AA</b>		Set the device back to factory settings. Code <b>85</b> (see table 3.7 of page 3.23). <b>Warning:</b> after the reset, 1, 2 and 8 buttons digital encoders will be set to 4 buttons digital encoder.factory settings.
<b>Codes used to deactivate the camera upon call of 2 user groups</b> (see section on page 3.22)		
<b>4E</b>		first address in group 1 (see codes of table 3.7 on pages 3.23, 3.24 and 3.25)
<b>5E</b>		last address in group 1 (see codes of table 3.7 on pages 3.23, 3.24 and 3.25)
<b>6E</b>		first address in group 2 (see codes of table 3.7 on pages 3.23, 3.24 and 3.25)
<b>7E</b>		last address in group 2 (see codes of table 3.7 on pages 3.23, 3.24 and 3.25)

\* This programming is useful when the push button panel has more buttons than the connected users and to prevent the case when, by pressing an enabled button, the system gets busy.

Programming operations to be made:

- microswitch 3 of MS2 = position OFF
- microswitch 4 of MS2 = position OFF (3 seconds) or ON (6 seconds)
- code 1E = insert address of last user in group 1 (example: if you enter 99 you will have: group 1 with codes from 1 to 99; group 2 from 100 to 200).

**How to deactivate the camera upon call**


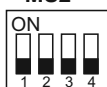
You can create 2 groups of user addresses that will not activate the camera during the call from the external door station. This function is used to avoid the temporary turn-on of white LEDs in the colour camera module during calls to intercoms or actuators 2281.

**How to set address groups (codes 4E, 5E, 6E and 7E)**

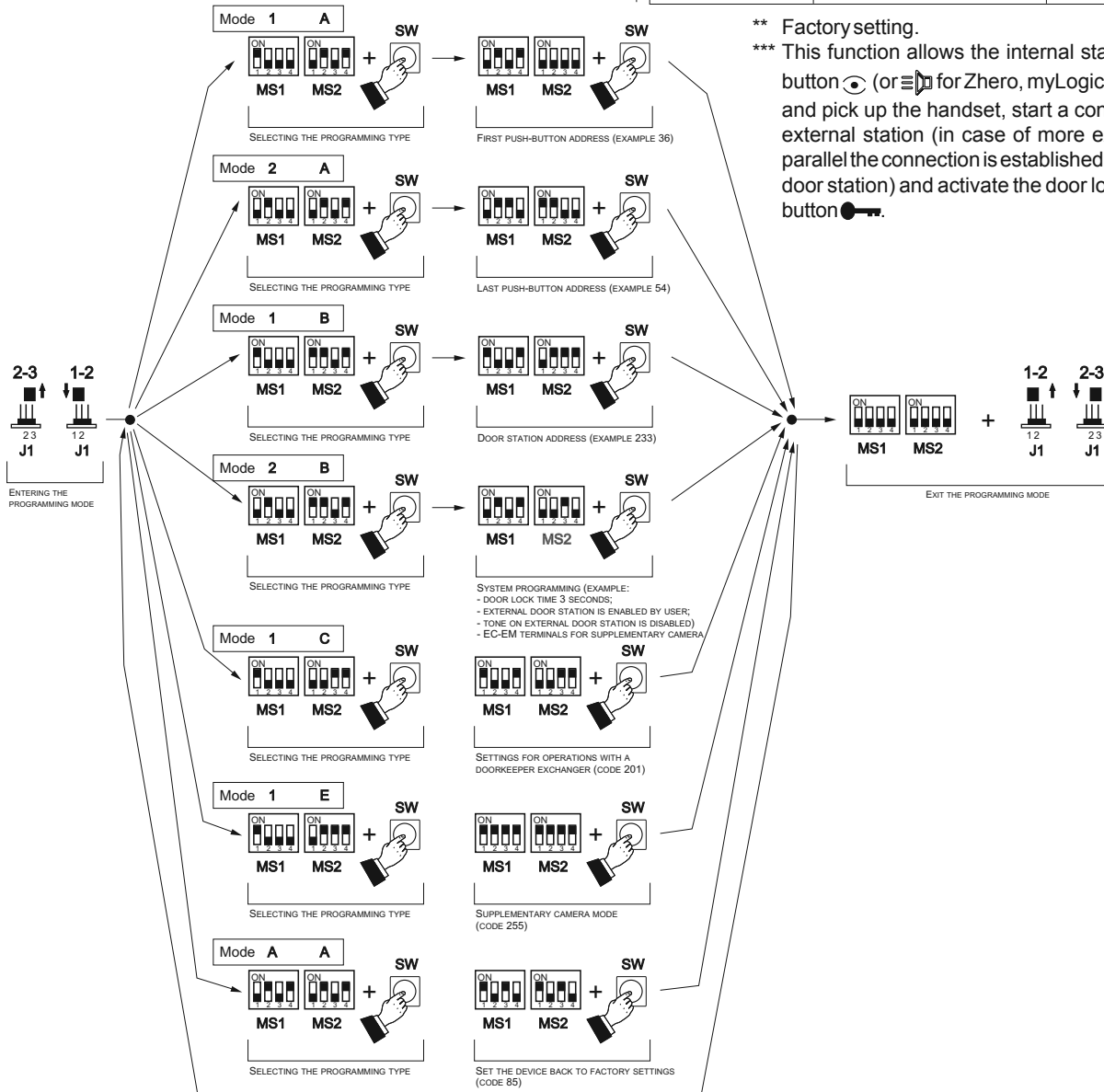
- enter the programming mode as illustrated in "enter the programming mode";
- set code 4E in microswitches MS1 and MS2 and press button SW; you will hear the confirmation tone;
- set the address number of the first user in group 1 in microswitches MS1 and MS2 (see table 3.7 on page 3.23);
- press button SW; you will hear the confirmation tone;
- set code 5E in microswitches MS1 and MS2 and press button SW; you will hear the confirmation tone;
- set the address number of the last user in group 1 and press button SW; you will hear the confirmation tone;

(continued on page 3.23)




**Table 3.6**  
Operating mode of the system (code 2B)

		Microswitches position of MS1 and MS2	
Micro-switches		OFF	ON
MS1 	1	door lock activation time; 3 seconds **	door lock activation time; 6 seconds
	2	deactivation upon call from internal station ***	activation upon call from internal station **
	3	reserved: to leave in position OFF **	
4	ACTIVATION of tone generator on the external door station **	DEACTIVATION of tone generator on the external door station	
MS2 	1-2	reserved: to leave in position OFF **	
	3	ordinary management of terminals EC-EM (see programming 1E-table 3.5) **	management of terminals EC-EM for additional camera
	4	supplementary door lock activation time; 3 seconds **	supplementary door lock activation time; 6 seconds

**Example of programming for digital encoders**



\*\* Factory setting.

\*\*\* This function allows the internal stations to press the button  (or  for Zhero, myLogic and Echos series) and pick up the handset, start a conversation with the external station (in case of more external stations in parallel the connection is established with the last calling door station) and activate the door lock by pressing the button .



- repeat the operations above to enter the address of the first and last user in group 2 (codes **6E** and **7E**, respectively);
- press button **SW** to exit the programming mode.

Table 3.7

Cross-reference table between codes and microswitches position of MS1 and MS2.

	MS1	MS2		MS1	MS2		MS1	MS2		MS1	MS2		MS1	MS2
1			21			41			61			81		
2			22			42			62			82		
3			23			43			63			83		
4			24			44			64			84		
5			25			45			65			85		
6			26			46			66			86		
7			27			47			67			87		
8			28			48			68			88		
9			29			49			69			89		
10			30			50			70			90		
11			31			51			71			91		
12			32			52			72			92		
13			33			53			73			93		
14			34			54			74			94		
15			35			55			75			95		
16			36			56			76			96		
17			37			57			77			97		
18			38			58			78			98		
19			39			59			79			99		
20			40			60			80			100		

101		121		141		161		181	
102		122		142		162		182	
103		123		143		163		183	
104		124		144		164		184	
105		125		145		165		185	
106		126		146		166		186	
107		127		147		167		187	
108		128		148		168		188	
109		129		149		169		189	
110		130		150		170		190	
111		131		151		171		191	
112		132		152		172		192	
113		133		153		173		193	
114		134		154		174		194	
115		135		155		175		195	
116		136		156		176		196	
117		137		157		177		197	
118		138		158		178		198	
119		139		159		179		199	
120		140		160		180		200	

201	MS1 ON 1 2 3 4	MS2 ON 1 2 3 4	212	MS1 ON 1 2 3 4	MS2 ON 1 2 3 4	223	MS1 ON 1 2 3 4	MS2 ON 1 2 3 4	234	MS1 ON 1 2 3 4	MS2 ON 1 2 3 4	245	MS1 ON 1 2 3 4	MS2 ON 1 2 3 4
202	ON 1 2 3 4	ON 1 2 3 4	213	ON 1 2 3 4	ON 1 2 3 4	224	ON 1 2 3 4	ON 1 2 3 4	235	ON 1 2 3 4	ON 1 2 3 4	246	ON 1 2 3 4	ON 1 2 3 4
203	ON 1 2 3 4	ON 1 2 3 4	214	ON 1 2 3 4	ON 1 2 3 4	225	ON 1 2 3 4	ON 1 2 3 4	236	ON 1 2 3 4	ON 1 2 3 4	247	ON 1 2 3 4	ON 1 2 3 4
204	ON 1 2 3 4	ON 1 2 3 4	215	ON 1 2 3 4	ON 1 2 3 4	226	ON 1 2 3 4	ON 1 2 3 4	237	ON 1 2 3 4	ON 1 2 3 4	248	ON 1 2 3 4	ON 1 2 3 4
205	ON 1 2 3 4	ON 1 2 3 4	216	ON 1 2 3 4	ON 1 2 3 4	227	ON 1 2 3 4	ON 1 2 3 4	238	ON 1 2 3 4	ON 1 2 3 4	249	ON 1 2 3 4	ON 1 2 3 4
206	ON 1 2 3 4	ON 1 2 3 4	217	ON 1 2 3 4	ON 1 2 3 4	228	ON 1 2 3 4	ON 1 2 3 4	239	ON 1 2 3 4	ON 1 2 3 4	250	ON 1 2 3 4	ON 1 2 3 4
207	ON 1 2 3 4	ON 1 2 3 4	218	ON 1 2 3 4	ON 1 2 3 4	229	ON 1 2 3 4	ON 1 2 3 4	240	ON 1 2 3 4	ON 1 2 3 4	251	ON 1 2 3 4	ON 1 2 3 4
208	ON 1 2 3 4	ON 1 2 3 4	219	ON 1 2 3 4	ON 1 2 3 4	230	ON 1 2 3 4	ON 1 2 3 4	241	ON 1 2 3 4	ON 1 2 3 4	252	ON 1 2 3 4	ON 1 2 3 4
209	ON 1 2 3 4	ON 1 2 3 4	220	ON 1 2 3 4	ON 1 2 3 4	231	ON 1 2 3 4	ON 1 2 3 4	242	ON 1 2 3 4	ON 1 2 3 4	253	ON 1 2 3 4	ON 1 2 3 4
210	ON 1 2 3 4	ON 1 2 3 4	221	ON 1 2 3 4	ON 1 2 3 4	232	ON 1 2 3 4	ON 1 2 3 4	243	ON 1 2 3 4	ON 1 2 3 4	254	ON 1 2 3 4	ON 1 2 3 4
211	ON 1 2 3 4	ON 1 2 3 4	222	ON 1 2 3 4	ON 1 2 3 4	233	ON 1 2 3 4	ON 1 2 3 4	244	ON 1 2 3 4	ON 1 2 3 4	255	ON 1 2 3 4	ON 1 2 3 4

**Tone table**

**End of conversation / wrong programming.**

Indicates an error during the programming phase or that the conversation time is near to expire.



**Busy.**

Indicates that the user is busy or not existing or that the line is busy.



**Dissuasion.**

Indicates that the push-buttons were wrongly programmed.



**Programming .**

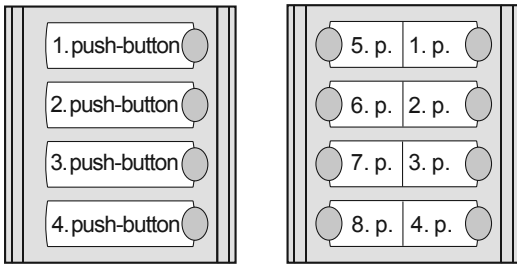
Indicates that the programming mode was accessed.



**Acknowledge.** It indicates that the operation was performed correctly (programming, call send, door lock in conversation, extension of conversation time)



**PUSH-BUTTON MODULES WITH INTEGRATED ENCODING BOARD**



The button modules with integrated encoding board, thanks to the connection to the encoder module CD2131PL+CD2138PL, allow the calls in DUO systems.

**PL24S.** Module with front plate and four aluminium call buttons. Complete with name holders with transparent screen green backlighting, resistant to breaking and connection cable to the next module.

**PL228S.** Same as the previous, but with 8 call buttons on two rows.

**Terminals**

- A+** AC or DC power supply input for name-plate Led (13Vac/dc-80mA)
- A-** AC power supply or ground input for name-plate Led

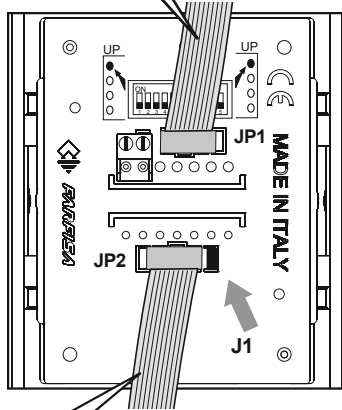
**Installation and connections**

- Connect the first push-button panel to the digital encoder module with the cable supplied.
- Connect the second push-button module to the first one with the cable supplied with the second module.
- Connect all modules in a sequence.
- Connect the two power supply wires of the name plate LED's (13Vac) to terminals **A+/A-** of the first push-button panel.

**Note**

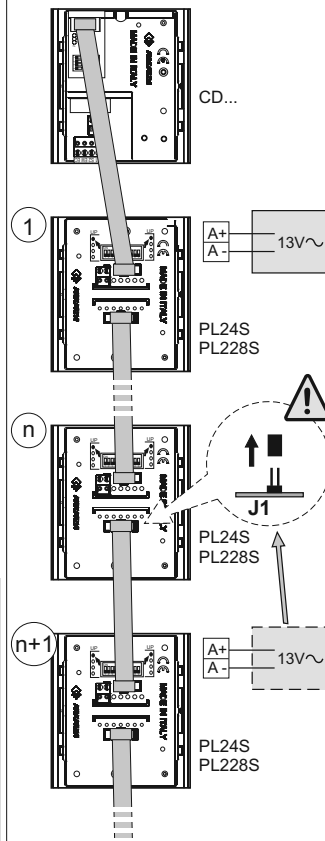
Great attention must be paid when the code 0 (numerical interval 0-3) is set on the micro-switches because in this case the first button, starting from the top of the module PL24S or PL228S will call no users. This is because the digital system does not recognize the address 0 (zero).

To previous push-buttons module or digital encoder



To next push-buttons module

**Power supply of the modules PL24S and PL228S with additional transformers**



Using 2 transformers to power the LED's of name plates, the 2 power supply units must be isolated by removing the jumper **J1** on the last module of the first group.

**Programming**

The microswitches, present on the back of the PL24S or PL228S, allow the digital encoder to recognize the code of the connected buttons, consequently they must be programmed properly. The programmed codes must correspond to the addresses of the internal users.

In case of installations with secondary door stations (multiple entrances), attention must be paid also to the numerical interval recognized by the digital exchanger. The code set on the microswitches (see tables 3.8 on page 3.27) determines the address of the users called by pressing the buttons of the push-button module in a sequence (starting from above) according to the following rule:

**Called User Address (IUC)** by pressing the buttons of the module (PL24S or PL228S) = **Address Associated with First Button (IPP)** of the digital encoder (CD2131-32-34PL or CD2138PL) + **Number Associated with Button (NAP)**.

General rule: **IUC = IPP + NAP**

General rule applied to the first example below;

- if you press the first button from above of the PL24S:

$$36 (IPP) + 4 (1^{st} NAP) = 40 (IUC)$$

the user with address 40 will be called.

**Examples:**

- If the first button of the digital encoder CD2134PL is associated with address 36 and code 4 is set on the microswitches of the first button module PL24S (numbers associated with buttons 4 ÷ 7), starting from up down, the buttons of the PL24S module will call the users with address 40, 41, 42 and 43.

- Addresses 38 and 39 will be lost when using the CD2132PL digital encoder and the art.PL24S as first push-button module.

- When using the digital coder CD2138PL the first 8 addresses are used for the coder itself. Therefore, set code 8 or higher on the first push-button module art. PL228S.

The following addresses are set in the example:

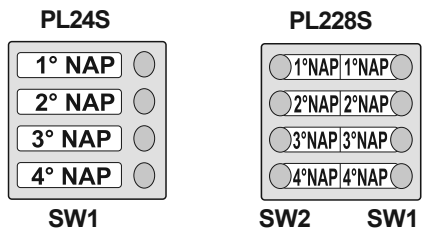
- 36 to coder CD2138PL
- 8 to first key on the right in module PL228S
- 12 to first key on the left in module PL228S

DUO system

Profilo

Table 3.8

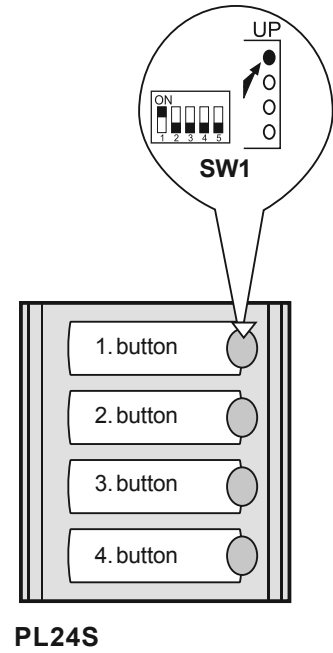
Example of order used to associate numbers with buttons



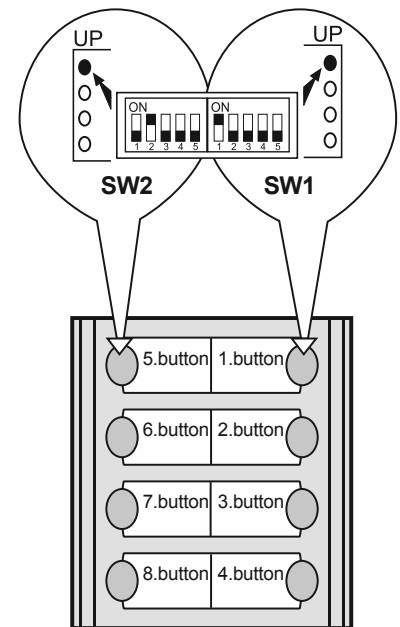
Code to be set	Numbers associated with buttons- NAP	Push-button micro-switch SW
4	1 <sup>st</sup> NAP = 4 2 <sup>nd</sup> NAP = 5 3 <sup>rd</sup> NAP = 6 4 <sup>th</sup> NAP = 7	
8	1 <sup>st</sup> NAP = 8 2 <sup>nd</sup> NAP = 9 3 <sup>rd</sup> NAP = 10 4 <sup>th</sup> NAP = 11	
12	1 <sup>st</sup> NAP = 12 2 <sup>nd</sup> NAP = 13 3 <sup>rd</sup> NAP = 14 4 <sup>th</sup> NAP = 15	
16	1 <sup>st</sup> NAP = 16 2 <sup>nd</sup> NAP = 17 3 <sup>rd</sup> NAP = 18 4 <sup>th</sup> NAP = 19	
20	1 <sup>st</sup> NAP = 20 2 <sup>nd</sup> NAP = 21 3 <sup>rd</sup> NAP = 22 4 <sup>th</sup> NAP = 23	
24	1 <sup>st</sup> NAP = 24 2 <sup>nd</sup> NAP = 25 3 <sup>rd</sup> NAP = 26 4 <sup>th</sup> NAP = 27	
28	1 <sup>st</sup> NAP = 28 2 <sup>nd</sup> NAP = 29 3 <sup>rd</sup> NAP = 30 4 <sup>th</sup> NAP = 31	
32	1 <sup>st</sup> NAP = 32 2 <sup>nd</sup> NAP = 33 3 <sup>rd</sup> NAP = 34 4 <sup>th</sup> NAP = 35	
36	1 <sup>st</sup> NAP = 36 2 <sup>nd</sup> NAP = 37 3 <sup>rd</sup> NAP = 38 4 <sup>th</sup> NAP = 39	
40	1 <sup>st</sup> NAP = 40 2 <sup>nd</sup> NAP = 41 3 <sup>rd</sup> NAP = 42 4 <sup>th</sup> NAP = 43	
44	1 <sup>st</sup> NAP = 44 2 <sup>nd</sup> NAP = 45 3 <sup>rd</sup> NAP = 46 4 <sup>th</sup> NAP = 47	
48	1 <sup>st</sup> NAP = 48 2 <sup>nd</sup> NAP = 49 3 <sup>rd</sup> NAP = 50 4 <sup>th</sup> NAP = 51	
52	1 <sup>st</sup> NAP = 52 2 <sup>nd</sup> NAP = 53 3 <sup>rd</sup> NAP = 54 4 <sup>th</sup> NAP = 55	
56	1 <sup>st</sup> NAP = 56 2 <sup>nd</sup> NAP = 57 3 <sup>rd</sup> NAP = 58 4 <sup>th</sup> NAP = 59	

Code to be set	Numbers associated with buttons- NAP	Push-button micro-switch SW
60	1 <sup>st</sup> NAP = 60 2 <sup>nd</sup> NAP = 61 3 <sup>rd</sup> NAP = 62 4 <sup>th</sup> NAP = 63	
64	1 <sup>st</sup> NAP = 64 2 <sup>nd</sup> NAP = 65 3 <sup>rd</sup> NAP = 66 4 <sup>th</sup> NAP = 67	
68	1 <sup>st</sup> NAP = 68 2 <sup>nd</sup> NAP = 69 3 <sup>rd</sup> NAP = 70 4 <sup>th</sup> NAP = 71	
72	1 <sup>st</sup> NAP = 72 2 <sup>nd</sup> NAP = 73 3 <sup>rd</sup> NAP = 74 4 <sup>th</sup> NAP = 75	
76	1 <sup>st</sup> NAP = 76 2 <sup>nd</sup> NAP = 77 3 <sup>rd</sup> NAP = 78 4 <sup>th</sup> NAP = 79	
80	1 <sup>st</sup> NAP = 80 2 <sup>nd</sup> NAP = 81 3 <sup>rd</sup> NAP = 82 4 <sup>th</sup> NAP = 83	
84	1 <sup>st</sup> NAP = 84 2 <sup>nd</sup> NAP = 85 3 <sup>rd</sup> NAP = 86 4 <sup>th</sup> NAP = 87	
88	1 <sup>st</sup> NAP = 88 2 <sup>nd</sup> NAP = 89 3 <sup>rd</sup> NAP = 90 4 <sup>th</sup> NAP = 91	
92	1 <sup>st</sup> NAP = 92 2 <sup>nd</sup> NAP = 93 3 <sup>rd</sup> NAP = 94 4 <sup>th</sup> NAP = 95	
96	1 <sup>st</sup> NAP = 96 2 <sup>nd</sup> NAP = 97 3 <sup>rd</sup> NAP = 98 4 <sup>th</sup> NAP = 99	
100	1 <sup>st</sup> NAP = 100 2 <sup>nd</sup> NAP = 101 3 <sup>rd</sup> NAP = 102 4 <sup>th</sup> NAP = 103	
104	1 <sup>st</sup> NAP = 104 2 <sup>nd</sup> NAP = 105 3 <sup>rd</sup> NAP = 106 4 <sup>th</sup> NAP = 107	
108	1 <sup>st</sup> NAP = 108 2 <sup>nd</sup> NAP = 109 3 <sup>rd</sup> NAP = 110 4 <sup>th</sup> NAP = 111	
112	1 <sup>st</sup> NAP = 112 2 <sup>nd</sup> NAP = 113 3 <sup>rd</sup> NAP = 114 4 <sup>th</sup> NAP = 115	
116	1 <sup>st</sup> NAP = 116 2 <sup>nd</sup> NAP = 117 3 <sup>rd</sup> NAP = 118 4 <sup>th</sup> NAP = 119	
120	1 <sup>st</sup> NAP = 120 2 <sup>nd</sup> NAP = 121 3 <sup>rd</sup> NAP = 122 4 <sup>th</sup> NAP = 123	
124	1 <sup>st</sup> NAP = 124 2 <sup>nd</sup> NAP = 125 3 <sup>rd</sup> NAP = 126 4 <sup>th</sup> NAP = 127	

First button indication and relevant microswitch for coding



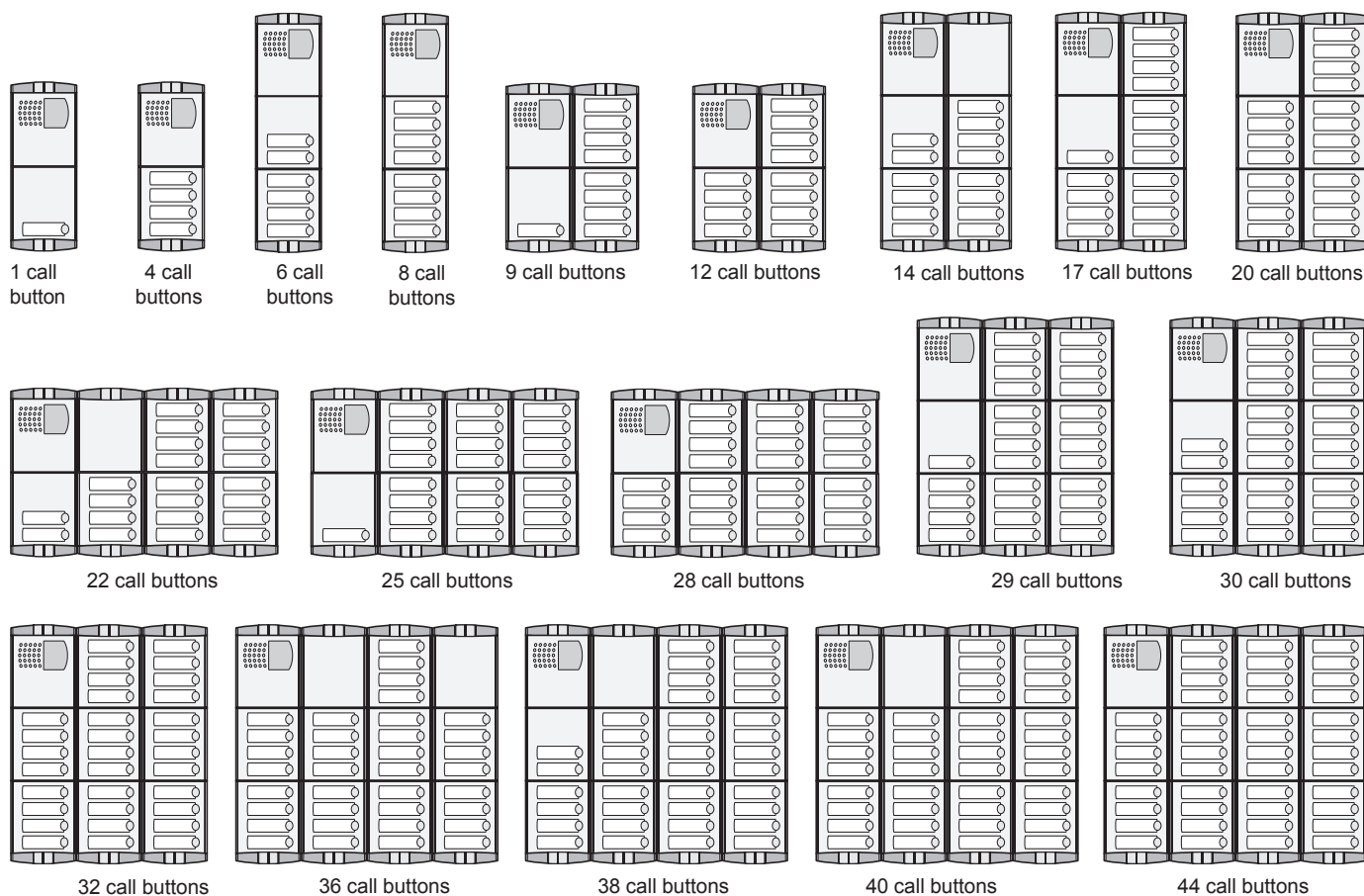
PL24S



PL228S

1 ROW PUSH-BUTTON PANEL

Examples of installations in videointercom systems



Composition board of push-button panels.

Nr calls	Dimensions	Encoder module	Camera and speaker module	Buttons, blank or number modules (*)		Back boxes and mod. frame (**)	Rain shelters
1	100x253.5x19 (3 15/16" x 10" x 3/4")	1 CD2131PL	1 VD2120CPL	-	-	1 PL72	1 PL92
4		1 CD2134PL	1 VD2120CPL	-	-	1 PL72	1 PL92
6	100x365x19 (3 15/16" x 14 3/8" x 3/4")	1 CD2132PL	1 VD2120CPL	1 PL24S	-	1 PL73	1 PL93
8		1 CD2134PL	1 VD2120CPL	1 PL24S	-	1 PL73	1 PL93
9	200x253.5x19 (7 7/8" x 10" x 3/4")	1 CD2131PL	1 VD2120CPL	2 PL24S	-	2 PL72	1 PL94
12		1 CD2134PL	1 VD2120CPL	2 PL24S	-	2 PL72	1 PL94
14	200x365x19 (7 7/8" x 14 3/8" x 3/4")	1 CD2132PL	1 VD2120CPL	3 PL24S	1 PL20	2 PL73	1 PL96
17		1 CD2131PL	1 VD2120CPL	4 PL24S	-	2 PL73	1 PL96
20		1 CD2134PL	1 VD2120CPL	4 PL24S	-	2 PL73	1 PL96
22	400x253.5x19 (15 3/4" x 10" x 3/4")	1 CD2132PL	1 VD2120CPL	5 PL24S	1 PL20	4 PL72	-
25		1 CD2131PL	1 VD2120CPL	6 PL24S	-	4 PL72	-
28	300x365x19 (11 13/16" x 14 3/8" x 3/4")	1 CD2134PL	1 VD2120CPL	6 PL24S	-	4 PL72	-
29		1 CD2131PL	1 VD2120CPL	7 PL24S	-	3 PL73	1 PL99
30		1 CD2132PL	1 VD2120CPL	7 PL24S	-	3 PL73	1 PL99
32	400x365x19 (15 3/4" x 14 3/8" x 3/4")	1 CD2134PL	1 VD2120CPL	7 PL24S	-	3 PL73	1 PL99
36		1 CD2134PL	1 VD2120CPL	8 PL24S	2 PL20	4 PL73	-
37		1 CD2131PL	1 VD2120CPL	9 PL24S	1 PL20	4 PL73	-
38		1 CD2132PL	1 VD2120CPL	9 PL24S	1 PL20	4 PL73	-
40		1 CD2134PL	1 VD2120CPL	9 PL24S	1 PL20	4 PL73	-
41		1 CD2131PL	1 VD2120CPL	10 PL24S	-	4 PL73	-
44	1 CD2134PL	1 VD2120CPL	10 PL24S	-	4 PL73	-	

For intercom installations replace art. VD2120CPL with AD2120CPL

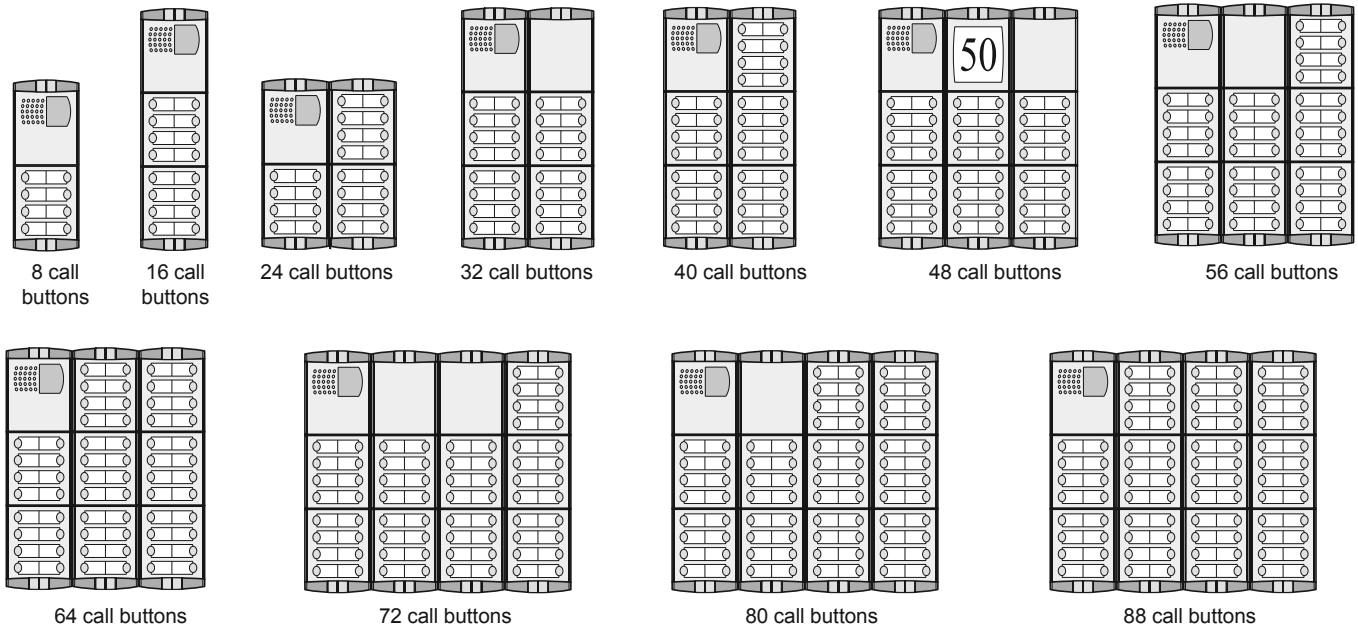
(\*\*) Hood covers can be added, if necessary (see page 3.11)

(\*) PL50

It replaces PL72 or PL73

2 ROW PUSH-BUTTON PANEL

Examples of installations in videointercom systems



Composition board of push-button panels.

Nr calls	Dimensions	Encoder module	Camera and speaker module	Buttons, blank or number modules (*)		Back boxes and mod. frame (**)	Rain shelters
8	100x253.5x19 (3 15/16" x 10" x 3/4")	1 CD2138PL	1 VD2120CPL	-	-	1 PL72	1 PL92
16	100x365x19 (3 15/16" x 14 3/8" x 3/4")	1 CD2138PL	1 VD2120CPL	1 PL228S	-	1 PL73	1 PL93
24	200x253.5x19 (7 7/8" x 10" x 3/4")	1 CD2138PL	1 VD2120CPL	2 PL228S	-	2 PL72	1 PL94
32	200x365x19 (7 7/8" x 14 3/8" x 3/4")	1 CD2138PL	1 VD2120CPL	3 PL228S	1 PL20	2 PL73	1 PL96
40	200x365x19 (7 7/8" x 14 3/8" x 3/4")	1 CD2138PL	1 VD2120CPL	4 PL228S	-	2 PL73	1 PL96
48	300x365x19 (11 13/16" x 14 3/8" x 3/4")	1 CD2138PL	1 VD2120CPL	5 PL228S	2 PL20	3 PL73	1 PL99
56	300x365x19 (11 13/16" x 14 3/8" x 3/4")	1 CD2138PL	1 VD2120CPL	6 PL228S	1 PL20	3 PL73	1 PL99
64	300x365x19 (11 13/16" x 14 3/8" x 3/4")	1 CD2138PL	1 VD2120CPL	7 PL228S	-	3 PL73	1 PL93
72	400x365x19 (15 3/4" x 14 3/8" x 3/4")	1 CD2138PL	1 VD2120CPL	8 PL228S	2 PL20	4 PL73	-
80	400x365x19 (15 3/4" x 14 3/8" x 3/4")	1 CD2138PL	1 VD2120CPL	9 PL228S	1 PL20	4 PL73	-
88	400x365x19 (15 3/4" x 14 3/8" x 3/4")	1 CD2138PL	1 VD2120CPL	10 PL228S	-	4 PL73	-

For intercom installations replace art. VD2120CPL with AD2120CPL

(\*) PL50

It replaces PL72 or PL73


(\*\*) Hood covers can be added, if necessary (see page 3.11)

## OPERATION


Check that all the connections are correct. Connect the power supply unit to the mains.


To make a call press the button corresponding to the desired user. Call is confirmed by an acknowledge tone, if the communication line is available, or denied by a busy tone if the communication line is not available (see *tone table on page 3.25*).

Called equipment rings only once, but if in this phase the same calling button on the external station is pressed again the equipment will ring another time.

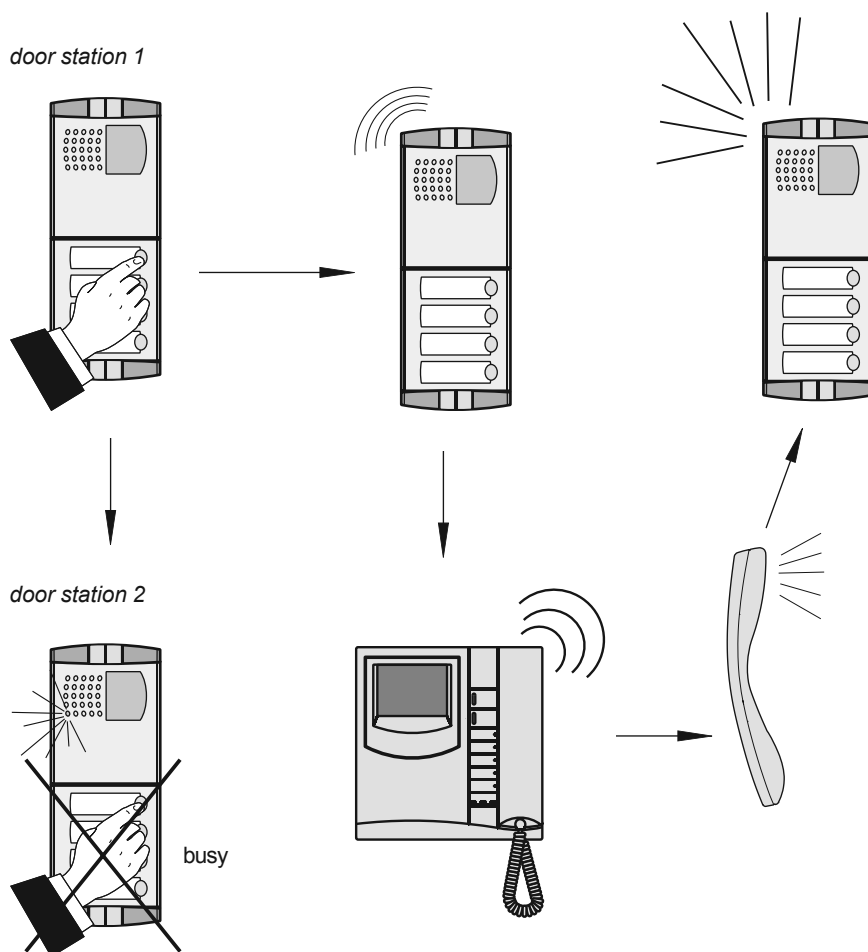
The called user picks up the handset (or press  for Zhero, myLogic and Echos series) enables the conversation with the external station for 90 seconds.

A tone will advise the user 10 seconds before the conversation ends. To continue conversation for additional 90 seconds on the external station the calling button must be pressed again.

Press the  button to release the door lock. Door lock activation time is 3 seconds (or 6 seconds according to the system programming).

Replace the handset (or press  for Zhero, myLogic and Echos series) to end the conversation and restore the idle state.

In installations with **2 or more external door stations** when a call is made from one push-button panel, the other push-button panel are deactivated with a busy indication (red LED flashing on the audio or audio/video module).





Stainless steel (AISI 316L) anti-vandalism push-button panels especially studied to withstand burglary, penetration of solids and water jets (IP 45 protection degree against the penetration of external solids and water; IK09 against shocks).

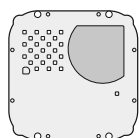
The Matrix push-button panels include back boxes, module frames, die-cast aluminium decorative frames, button modules, and modules with built-in speaker unit (with or without camera).

The careful selection of modules allows for multiple application opportunities; from one-way installations to blocks of flats; from intercom to video intercom installations. The push-button elements have been developed to allow both for horizontal and vertical configuration.



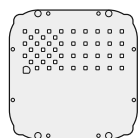
**Notice!** To maintain the brilliance of door station plates, periodic cleaning with specific products for stainless steel is required.

**Audio-video modules**



**VD2120CMAS**

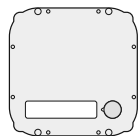
Colour camera with door speaker (see page 3.32).



**AD2110MAS**

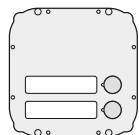
Door speaker module (for specifications see page 3.32).

**Digital modules**



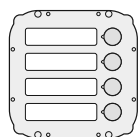
**CD2131MAS**

Digitizer module with 1 call button (for specifications see page 3.41).



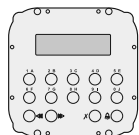
**CD2132MAS**

Digitizer module with 2 call buttons (for specifications see page 3.41).



**CD2134MAS**

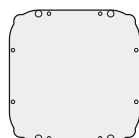
Digitizer module with 4 call buttons (for specifications see page 3.41).



**TD2100MAS.**

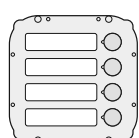
Digital door station (for specifications see page 3.35).

**Blank and button modules**



**MAS 20.**

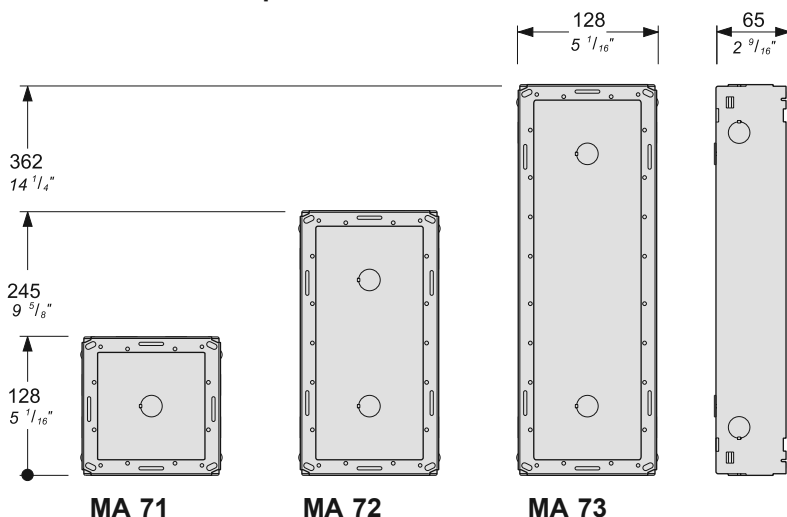
Blank module in stainless steel.



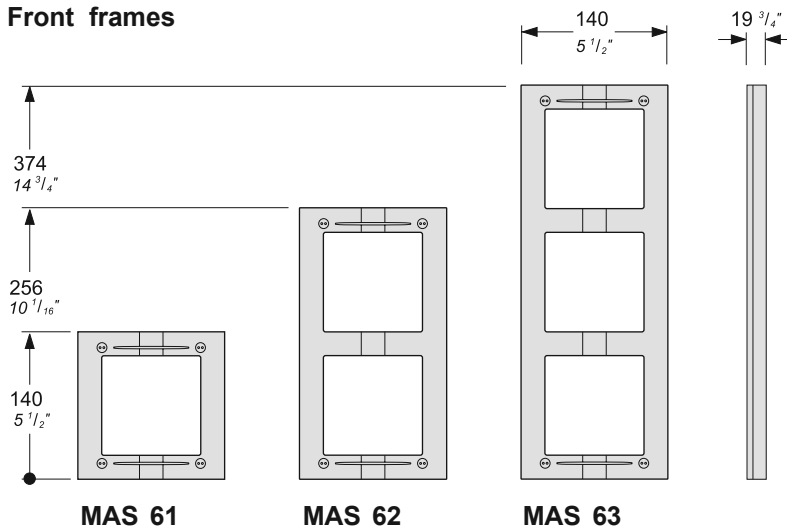
**MAS 24S.**

Module with 4 call buttons and encoding board (for specifications see page 3.44)

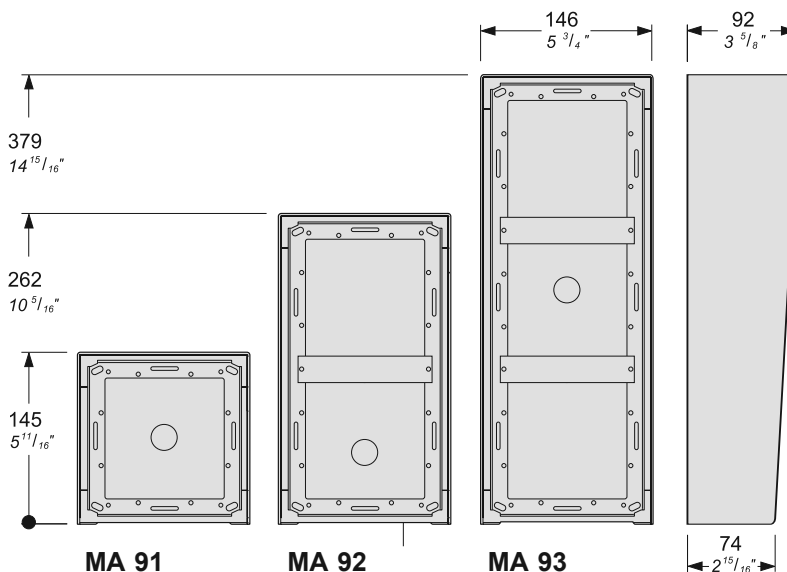
**Module frames complete with back box**



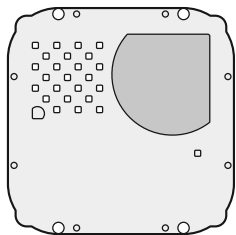
**Front frames**



**Rain shelters with module frames**



## AUDIO-VIDEO MODULE



### VD2120CMAS. Colour camera with door speaker

Module complete with:

- CCD camera with autoiris, fixed 3.6mm lens and 6 white LED's
- amplified speaker unit with reception volume and anti-feedback adjustments
- steel front plate with breakproof transparent screen
- horizontal and vertical adjustments
- red operation LED
- connection to the digital encoding modules (CD2131MAS, CD2132MAS and CD2134MAS) and digital door station (TD2100MAS) through the cable complete with connectors supplied together with the items listed here above.

#### Terminals

~ ~ 13VAC voltage input

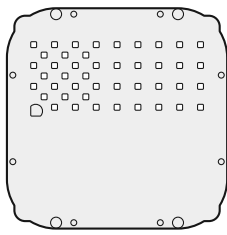
**V** Video signal input of a supplementary external camera (coaxial cable)

**M** Video ground (coaxial shield)

**EC** Positive signal for supplementary camera

**EM** Negative signal for supplementary camera

## AUDIO MODULE



### AD2110MAS. Door speaker module

Module complete with:

- amplified speaker unit with reception volume and anti-feedback adjustments
- steel front plate
- red operation LED
- connection to the digital encoding modules (CD2131MAS, CD2132MAS and CD2134MAS) and digital door station (TD2100MAS) through the cable complete with connectors supplied together with the items listed here above.

#### Terminals

~ ~ 13VAC voltage input

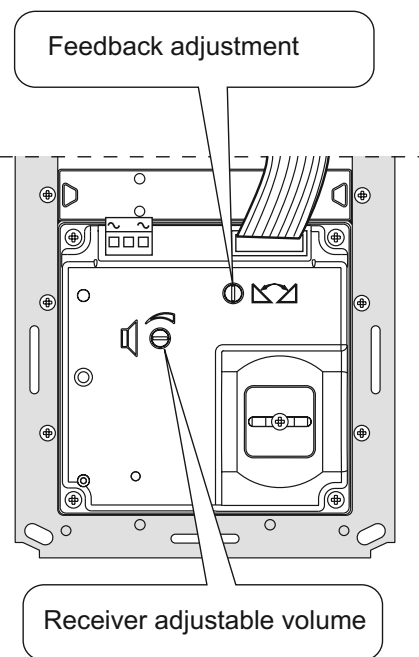
## VD2120CMAS and AD2110MAS audio adjustments

If necessary, you can adjust the volume of the 3 audio channels and the Larsen effect (feedback) with the relevant potentiometers.

### Anti-feedback adjustment

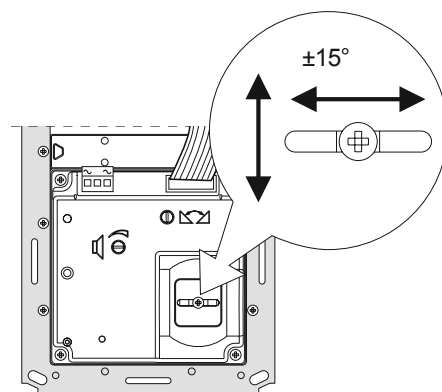
In case of "feedback" (Larsen effect) in the external unit it is necessary to operate as follows:

- make the call from the door station and lift the handset (press for Zhero, myLogic and Echos series) of the called user;
- adjust the trimmer " until the whistling stops (Larsen effect).



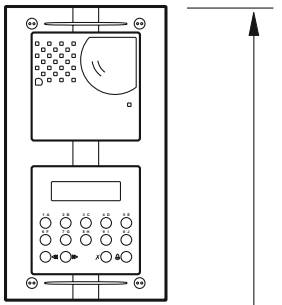
### Adjustments

You can manually change the camera framing by unloosening and adjusting the horizontal and vertical screws in the desired direction.



Technical data	VD2120CMAS	AD2110MAS
Power supply	13Vac±1	13Vac±1
Absorption with connection to encoder	0.8A	0.4A
Video signal output	balanced	
Video signal standard	PAL	
Minimum illumination	2.5Lux	
White balanced	automatic	
Led	6 white	
Sensor	CCD 1/3" colour	
Number of pixels	291,000	
Horizontal frequency	15,625Hz	
Vertical frequency	50Hz	
Lens	3.6mm	
Focus	0.6m ÷ ∞	
Autoiris	electronic	
Horizontal adjustment	± 15°	
Vertical adjustment	± 15°	
Operating temperature	-10°÷+40°C	-10°÷+40°C
Max. permissible humidity	80%RH	80%RH

## INSTALLATION

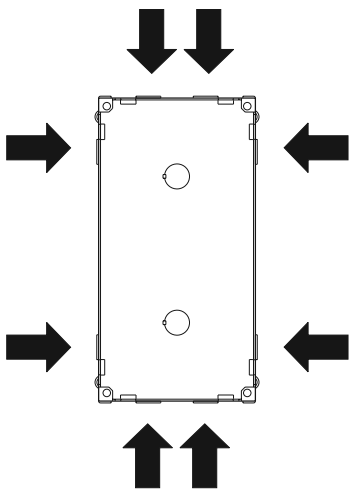


1.65m  
5' 5"

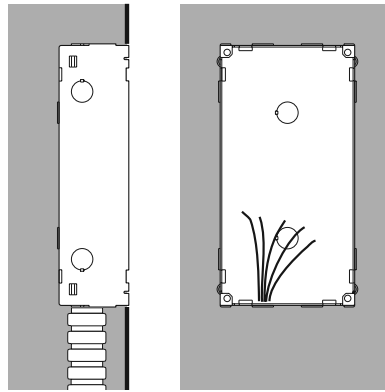


Place the push-button panel back box at a height of about 1.65m (5' 5") from the floor keeping the front edges flush-mounted and vertical to the finished plaster.

**Position the camera in such a way that sunlight or other direct or reflected light sources with high intensity do not hit the camera lens.**

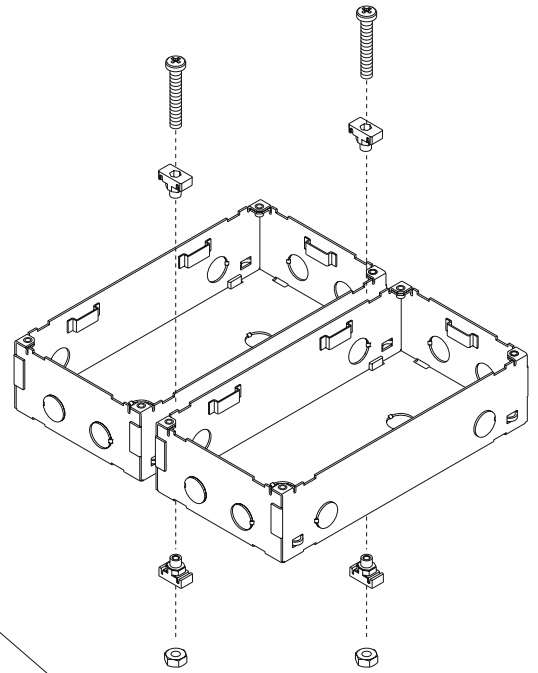


Openings for cables.

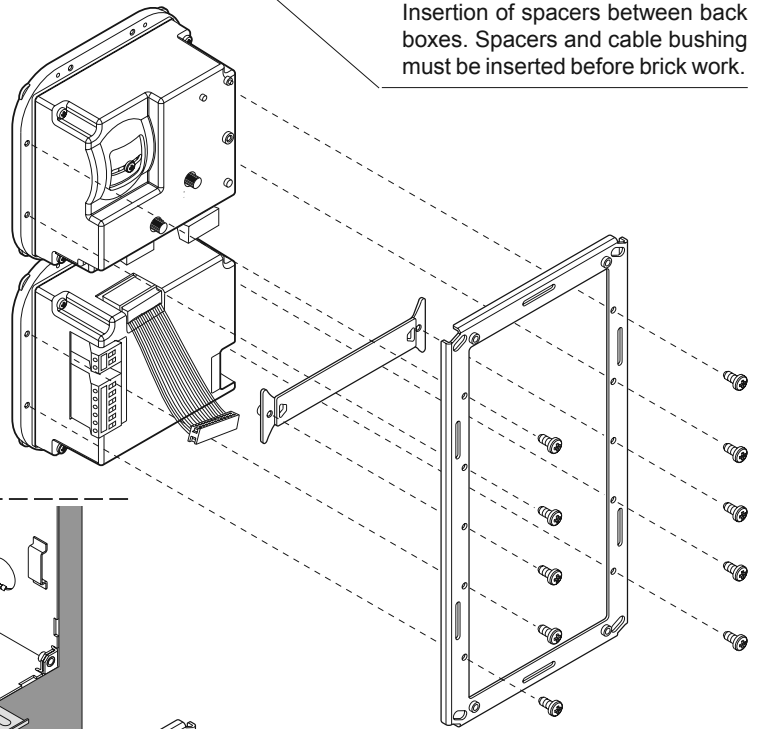


Flush mounting and cables placing.

### Assembling modules side by side

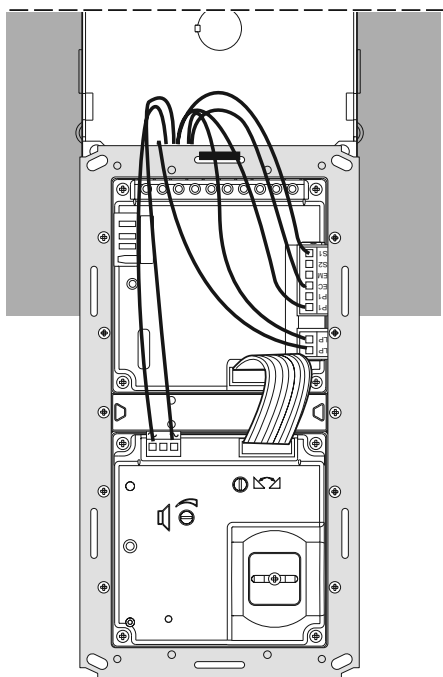


Insertion of spacers between back boxes. Spacers and cable bushing must be inserted before brick work.

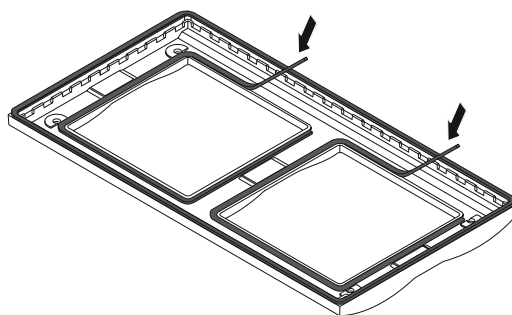


Mounting modules.

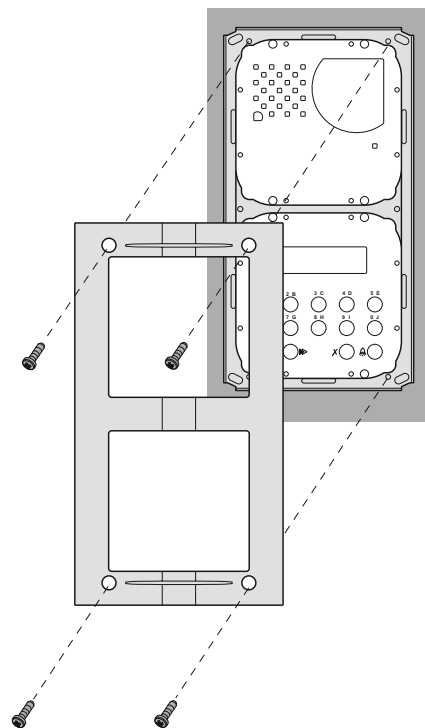
For easier connection to the electrical system, it is recommended to insert the metal plate supplied with the product in the back box opening, as shown in the figure. The plate is used to hook the frame with pre-assembled modules. Leave the plate in the box to reuse it for maintenance operations.



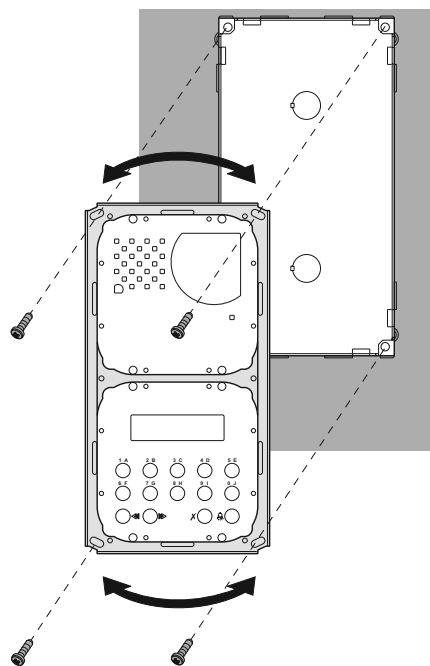
Connection of wires to module terminal boxes.



Apply the protection gaskets supplied with the product on the internal part of the frame openings.

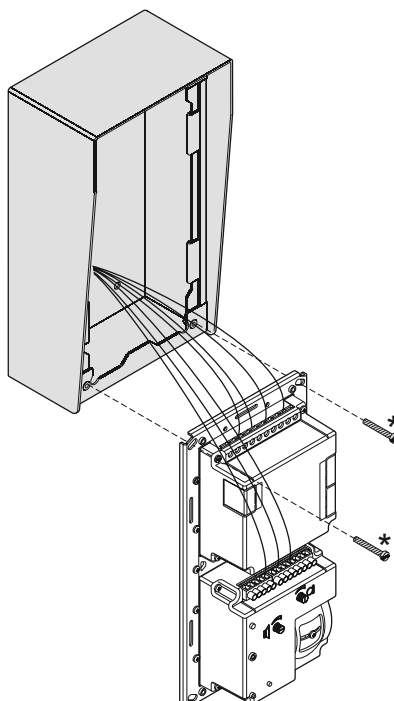


Fixing of frame to module frame.

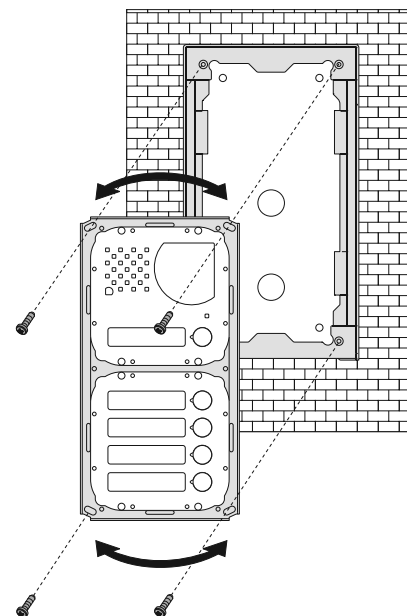


Fixing of frame to back box. Align the frame before tightening the screws.

## Rain shelters

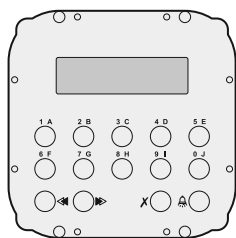


\* Long screws can be used to anchor the frame during wire connection to modules.



Fixing of frame to rain shelter. Align the frame before tightening the screws.

DIGITAL PUSH-BUTTON PANEL



**TD2100MAS.** Matrix series anti-vandalism steel push-button panel with 14 steel buttons and alphanumerical LCD. Used to dial and send calls over DUO digital line.

**Technical features**

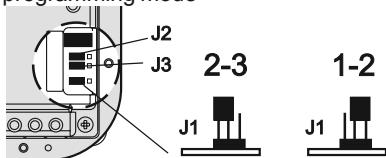
Power supply from audio/video module	
Door-opening time	3/6 seconds
LCD	2 lines x 16 characters
Number of calls	200
Memory	250 names
Dimensions	1 module
Operating temperature	0°+40°C
Maximum humidity acceptable	90% RH

**Terminals**

- LP/LP** audio-data-video to and from internal users
- P1/P1** direct call button inputs
- EC** positive signal for auxiliary service
- EM** negative signal for auxiliary service
- S1/S2** door opening contacts

**Positions of jumper J1**

- 2-3 = operation mode
- 1-2 = programming mode



**PROGRAMMING**

(instruction for article with software **AE040** or **higher**)

Before programming you must:

- Move the jumper **J1** on the back of the push-button panel from **2-3** to **1-2**; the display shows "Programming / type: ".

- Dial the programming code (see table 3.9) and press to confirm.
- After you program each single code, bring the jumper **J1** back to **2-3**.

**Table 3.9**  
**Programming codes**

<b>00</b>	Entry of codes for door lock / address P1 / address PE
<b>01</b>	Entry-modification-deletion of names
<b>02</b>	Language selection
<b>03</b>	System programming
<b>04</b>	Entry of display initial text
<b>05</b>	Loading names from PC
<b>06</b>	Ordering names
<b>10</b>	Address associated with EC-EM terminals
<b>20</b>	Settings for operations with a doorkeeper exchanger

**Entry of codes for door lock / address P1 / address PE (code 00)**

Enter the code **00** to access the "entry of door lock codes" mode. The display shows "PASSWORD 0 / ".

- Dial the first opening code on the keypad, for example 7890; the display shows "PASSWORD 0 / 7890".
- Press ; the display shows "PASSWORD 1 / ".
- Dial the second opening code on the keypad, for example 1234; the display shows "PASSWORD 1 / 1234".
- Press ; the display shows "PASSWORD 2 / ".
- Repeat the operation to enter a maximum of 16 codes. When you press to confirm the last code (PASSWORD 15) you enter the "entry of address P1 code" mode automatically. You can memorise the number of the internal station that can be called directly by pushing a button connected between terminals **P1 / P1**.
- Press ; the display shows "P1 / 0100".
- Press **X** to delete the code shown on the display and enter the number of the internal station you want to enable for the direct call function. The internal stations can be coded with numbers from 1 to 200.

- Press to confirm and go to the "entry of address PE code"; the display shows "PE / 0231 ". You can enter the code for the external station address. The push-button panels can be coded with numbers from 231 to 250.
- Dial the code and press to confirm. You go back to the "entry of door lock codes" mode. The display shows the PASSWORD 0 code (PASSWORD 0 / internal station)".
- To exit programming bring the jumper **J1** back to the original position (from 1-2 to 2-3).

**Modifying a code or address**

To change a code or address, you must enter the programming mode by moving the jumper **J1** from 2-3 to 1-2 and then:

- select the programming code **00**;
- press the button until the code you want to modify is displayed;
- press **X** to go to the code you want to modify.
- enter the new code on the keyboard and then press the button
- repeat the operation for all the codes you want to modify;
- move the jumper **J1** from 1-2 to 2-3 to exit the programming mode.

**Deleting a code or address**

To delete a code or address, you must enter the programming mode by moving the jumper **J1** from 2-3 to 1-2 and then:

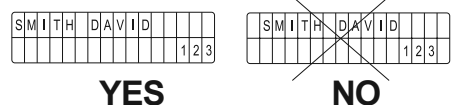
- select the programming code **00**;
- press the button until the code you want to delete is displayed;
- press **X** and then
- repeat the operation for all the codes you want to delete;
- move the jumper **J1** from 1-2 to 2-3 to exit the programming mode.

**Entry / modification / deletion of names (code 01)**

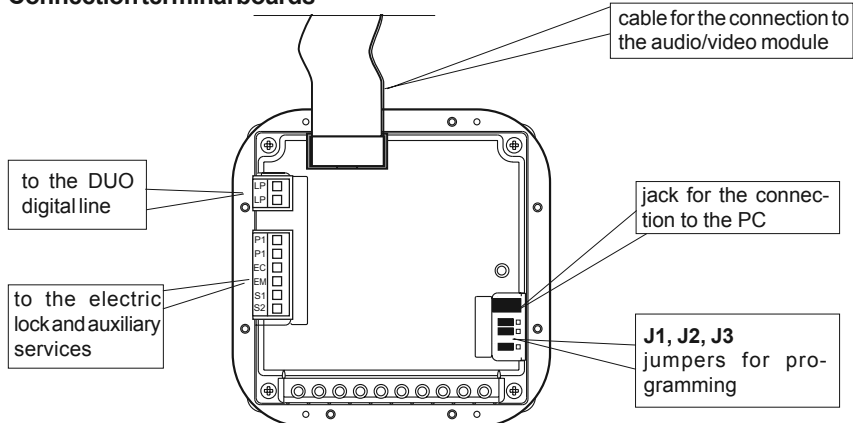
The digital keyboard TD2100MAS has an alphanumerical display with 32 characters that displays the user name and extension number (28 characters are used for the user name and the last 4 characters on bottom right are used for the extension number). To save them, you must follow the procedure illustrated below. The name must be entered starting from the first character on top left and the last digit of the extension number must be entered in the last position on bottom right, otherwise the number will not be saved (see "procedure to delete a name").

After you have entered all the names, the system will automatically order them alphabetically.

**Example**



**Connection terminal boards**



**Function of buttons when entering or modifying a name**

- 🔔 Hold this button pressed to scroll the list of existing names
- X Hold this button pressed to move the cursor to the name characters
- Hold this button pressed to scroll down the list of characters
- ⬅ Hold this button pressed to scroll up the list of characters

When searching for characters, the display shows uppercase letters, low-case letters, numbers, characters . <> and space in a sequence.

**Entry of names**

- Move the jumper **J1** from **2-3** to **1-2**.
- Enter the code **01** and press 🔔; the display shows the first name. The display is empty if no codes are programmed.
- Press ➤ or ⬅ to select the character for the first cell; press X to go to the second cell; press ➤ or ⬅ to select the character for the second cell; continue until you have entered the complete name with code. Press X after you have entered the number in the last cell on bottom right; the display shows "STORE USER / YES <> NO"; press ⬅ to confirm; press ➤ to modify the name.
- If confirmed, the display shows the second name. The display is empty if no names are programmed.
- Once you have confirmed the last name, bring the jumper **J1** back to the original position (from **1-2** to **2-3**). The display shows "waiting" and an automatic status bar. Normal operation is restored after a few seconds and the display shows the initial text (see "Operation" on page 3.40)

**Notes.** Once you have entered 250 names the display shows "waiting" and an automatic status bar. After a few seconds the display shows "Programming / type: " and you can continue with programming or exit by moving the jumper **J1** back to **2-3**. You can enter 2 or more names with the same call number (i.e. different family names in the same apartment).

**Modification or correction of names**

- Move the jumper **J1** from **2-3** to **1-2**.
- Enter the code **01** and press 🔔; the display shows the first name.
- Press 🔔 to search for the name you want to modify; (hold the button pressed for quick searching).
- Press X to go to the character you want to modify.
- Select the character with ➤ (forward) ⬅ (backward).
- Repeat the operation until you have completed the name modification.
- Once you have completed the modification, hold X pressed until the display shows "STORE USER / YES <> NO". Press ⬅ to confirm or ➤ to modify the name again. Enter a space to delete a letter.

**Addition of 1 or more names to the list**

- To add a new name to existing list you must:
- move the jumper **J1** from **2-3** to **1-2**.
  - enter the code **01** and press 🔔; the display shows the first name.
  - press 🔔 to scroll the list; the display is empty after the last name (hold the button pressed for quick searching).
  - to enter a new name follow the operations described in "Entry of names". If confirmed, the name is placed in the list in alphabetical order.

**Deletion of name**

- Move the jumper **J1** from **2-3** to **1-2**.
- Enter the code **01** and press 🔔; the display shows the first name.
- Press 🔔 to search for the name you want to delete; (hold the button pressed for quick searching).
- Press X to go to the last cell (bottom right); enter a space to delete the existing number.
- Press X again; the display shows "DELETE USER / YES <> NO". Press ➤ to confirm or ⬅ to go back to the name.
- Press ➤ to confirm or ⬅ to go back to the name. The next name is displayed after you have deleted the name.

**Language selection (code 02)**

You can choose the language from 6 different options (Italian, English, French, German, Spanish and Portuguese) in operation mode:

- Move the jumper **J1** from **2-3** to **1-2**.
- Enter the code **02** and press 🔔; the display shows "Italiano" in case of first programming or the programmed language.
- Press ➤ or ⬅ to select the language.
- Press 🔔 to confirm; the display shows "Programming / type: ".
- Continue by entering the code of a new programming or exit by moving the jumper **J1** back to **2-3**.

**System programming (code 03)**

You can change or activate the functions of the push-button panel (see table 3.10).

Before programming you must:

- Move the jumper **J1** from **2-3** to **1-2**.
- Enter the code **03** and press 🔔; the display shows "bit 0 = 0 / 0 <> 1" in case of first programming or "bit 0 = 1 / 0 <> 1" if changed in the previous programming.
- Press ➤ to select 1 or ⬅ to select 0.
- Press 🔔 to confirm and go to the next code (see code table with descriptions).
- Once you have confirmed the value of the last code (bit 7), the display shows "Programming / type: ".
- Continue by entering the code of a new programming or exit by moving the jumper **J1** back to **2-3**.

**Personalisation of display initial text (code 04)**

You can modify the text shown on the display during normal operation or idle state. You must program bit 5 to display the text (see "system programming").

To insert the personalized text you must:

- Move the jumper **J1** from **2-3** to **1-2**.
- Enter the code **04** and press 🔔; the display shows "DUO System", in case of first programming, or the text you want to replace.
- For information on how to enter the characters see "entry of names".
- Press 🔔 to confirm; the display shows "Programming / type: ".

**Table 3.10 - Table of system programming codes (code 03)**

Programming code	Function description	Default value	Value entered with buttons	
			⬅ = 0	➤ = 1
bit 0	door lock activation time	3 sec.	3 seconds	6 seconds
bit 1	activation upon call from internal station (1)	YES	NO	YES
bit 2	door lock activation with X (2)	NO	NO	YES
bit 3	deactivation of tone generator on the external door station	NO	NO	YES
bit 4	activation of personalised initial screen (3)	NO	NO	YES
bit 5	deactivation of ACI FARFISA and activation of personalised text	NO	NO	YES
bit 6	EC-EM terminals for additional camera switching	NO	NO	YES
bit 7	activation time of the EC-EM terminals for supplementary lock	3 sec.	3 seconds	6 seconds

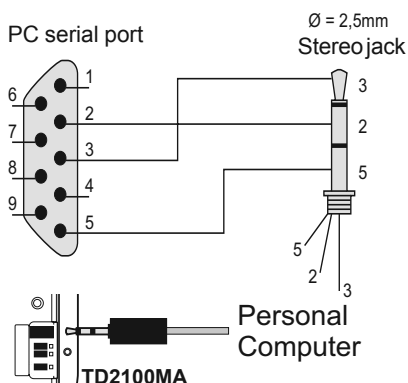
- (1) This function allows the internal stations to press the 📞 button and pick up the handset (or pressing 📞 in Zhero, Echos, myLogic models), start a conversation with the external station (in case of more external stations in parallel the connection is established with the last calling door station) and activate the door lock by pressing the button 🔑.
- (2) This functions allows for quicker door lock activation by pressing X rather than dialling the code 00+ 🔔. For example: press X + password + 🔔.
- (3) You can alternate "ACI FARFISA" with the personalised text (see "personalisation of display initial text").

- Continue by entering the code of a new programming or exit by moving the jumper **J1** back to **2-3**.

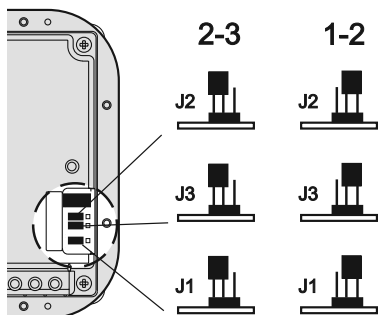
**Loading names from PC (code 05)**

You can load names directly from your PC.

- Load the names on the PC using a dedicated software application (*software supplied on demand*).
- Turn OFF the push-button panel and the PC.
- Connect the PC serial port to the stereo jack on the back of the push-button panel with a cable as shown in the figure.



- Move the jumpers **J1**, **J2** and **J3** on the back of the push-button panel from **2-3** to **1-2**.



- Turn on the PC and then the push-button panel.
- Enter the code **05**; the display shows "TD2100MA > PC / in progress 0".
- Download the names from the PC within 15 seconds; the display shows "TD2100MA <—> PC / in progress 1", "TD2100MA <—> PC / in progress 2" and then the downloaded names. At the end of download the push-button deletes the existing names. The first line of the display shows "waiting" and the second line shows a status bar to show the progress of the deletion operation. At the end the display shows "Programming / type: ".
- Turn off the push-button panel and then the PC.
- Disconnect the cable from the PC and the push-button panel.
- Bring the jumpers **J1**, **J2** and **J3** back to **2-3**.

**Ordering names (code 06)**

You can list the names in alphabetical order (from A to Z).

- Move the jumper **J1** from **2-3** to **1-2**.
- Enter the code **06**; the first line of the display shows "waiting" and the second line shows a status bar; at the end of the operation the push-button panel returns automatically to the programming mode (the display shows "Programming / type:").
- Exit the programming mode by bringing the jumper **J1** back to **2-3**.

**How to enter the address of EC-EM terminals (code 10)**

- Move the jumper **J1** from **2-3** to **1-2**.
- Enter the code **10** and press ; the display shows "ADDRESS EC".
- Dial the number of the desired address (255 for relay or camera activation mode; 250 for door lock mode; number of internal station before the first user of the supplementary door lock service).
- Press to confirm.
- Exit the programming mode by bringing the jumper **J1** back to **2-3**.

**Operations whit doorkeeper exchangers (code 20)**

Following settings are necessary if in the system are installed main and/or secondary door keeper exchangers.

For programming you must:

- enter the code **20** and press the button ; on the first line of the display appears the writing "Address PDX"; on the second line is displayed the address saved previously or empty spaces if no address was stored previously;
- delete all the addresses saved previously by pressing the button **X** and/or enter the address **201** if the push-button panel sends calls to 1 or more main stations or the address **210** if the push-button panel sends calls to 1 or more secondary stations;
- press the button to confirm the setting;
- to exit the programming mode, bring the jumper **J1** to position **A**.

**Return to operation mode**

Once you have completed programming, bring the jumper **J1** back to **2-3**; the display shows "ACI FARFISA / press <>" or the text you have entered during programming (see "Personalisation of display initial text").

**EC-EM TERMINALS**

The EC-EM terminals can be used to connect:

- one active relay during the call and for the entire conversation (default)
- one additional camera
- one additional door lock

To have these functions you must connect the terminals correctly and make some

programming operations on the TD2100MAS push-button panel.

**- Connection of one relay (see fig. 1)**

Programming operations to be made:

- code **03** = set bit 6 at 0
- code **03** = set bit 7 at 0
- code **10** = enter address **255**

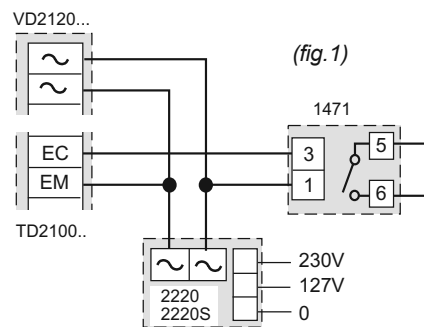
**- Connection of one additional camera**

For this use you must connect the EC and EM terminals to the corresponding terminals of the audio/video module (see diagrams si51VM/32 and si51VM/169 on chapter 5).

Programming operations to be made:

- code **03** = set bit 6 at 1
- code **03** = set bit 7 at 0
- code **10** = enter address **255**

**- Connection of one additional door lock.** For this use you must connect a relay as shown in the figure and program the push-button panel according to the desired service. The presence of the additional door lock requires to change the password (code 00). The first 8 passwords will activate the door lock connected to terminals S1 and S2, and the remaining 8 passwords will activate the door lock connected to terminals EC and EM.



**1) - activation of door lock from turn-ON button of internal stations**

This function can be activated only during a conversation with the external door station. In idle state the buttons will activate the external door station.

Programming operations to be made:

- code **03** = set bit 6 at 0
- code **03** = set bit 7 at 0 (3 seconds) or 1 (6 seconds)
- code **10** = enter address **250**

**2) - activation of door lock from button of internal stations**

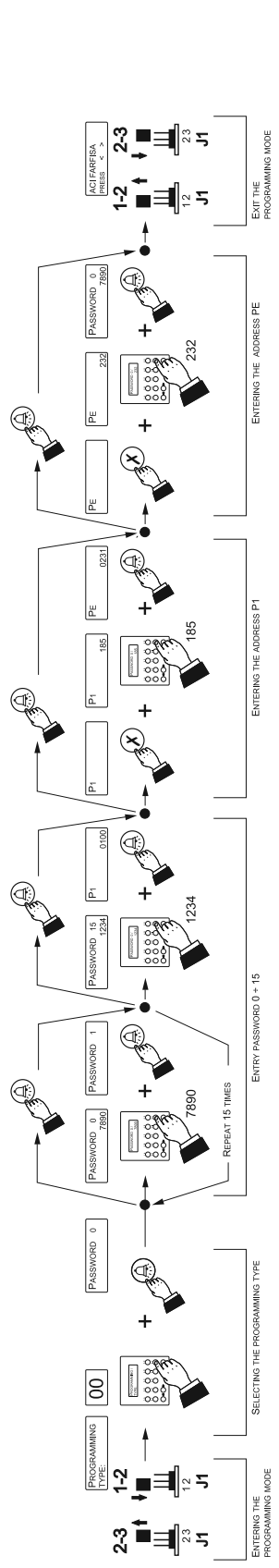
This programming allows for having two groups of users connected to a single external door station, each of them with its own door lock. The division between the two groups is indicated by the number that is inserted in the programming of code 10 (see page 3.37). You must insert the last user number recognised by group 1 that will activate the door lock connected to terminals S1 and S2; all higher numbers will automatically be in group 2 and will activate the door lock connected to terminals EC and EM.

Programming operations to be made:

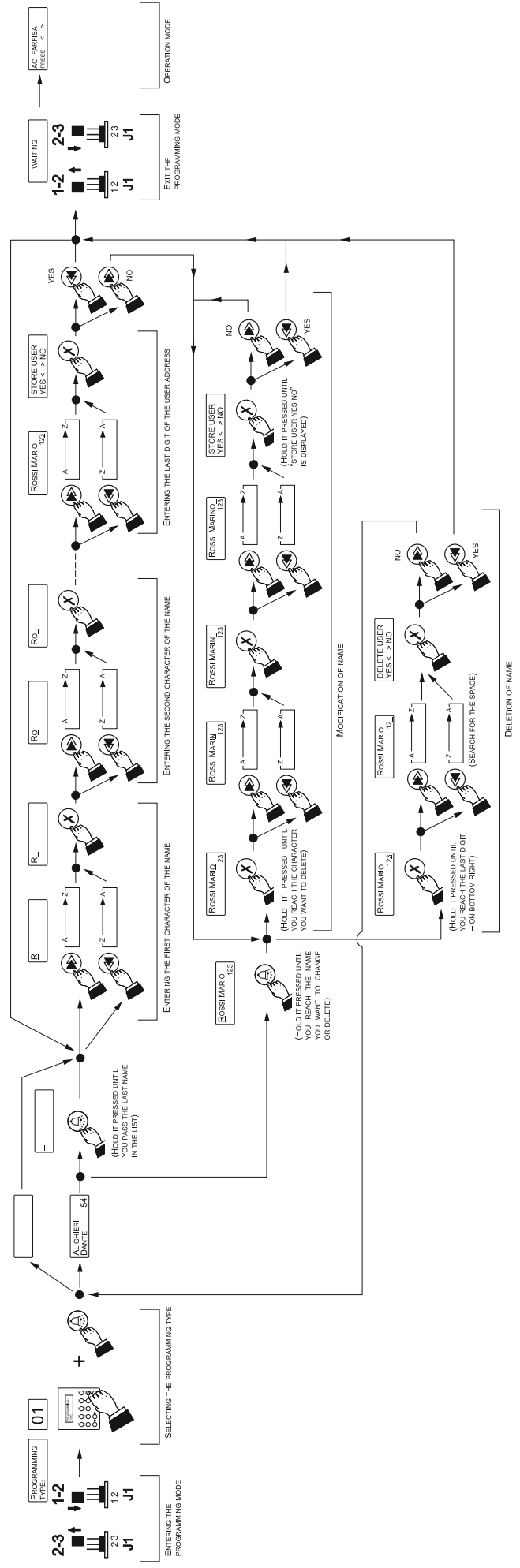
- code **03** = set bit 6 at 0
- code **03** = set bit 7 at 0 (3 seconds) or 1 (6 seconds)
- code **10** = insert address of last user in group 1 (example: if you enter 99 you will have: group 1 with codes from 1 to 99; group 2 from 100 to 200).

Example of programming for digital push-button panel TD2100MAS

Code 00 - Entry of password, address button P1 and address door station



Code 01 - Entry, modification and deletion of names



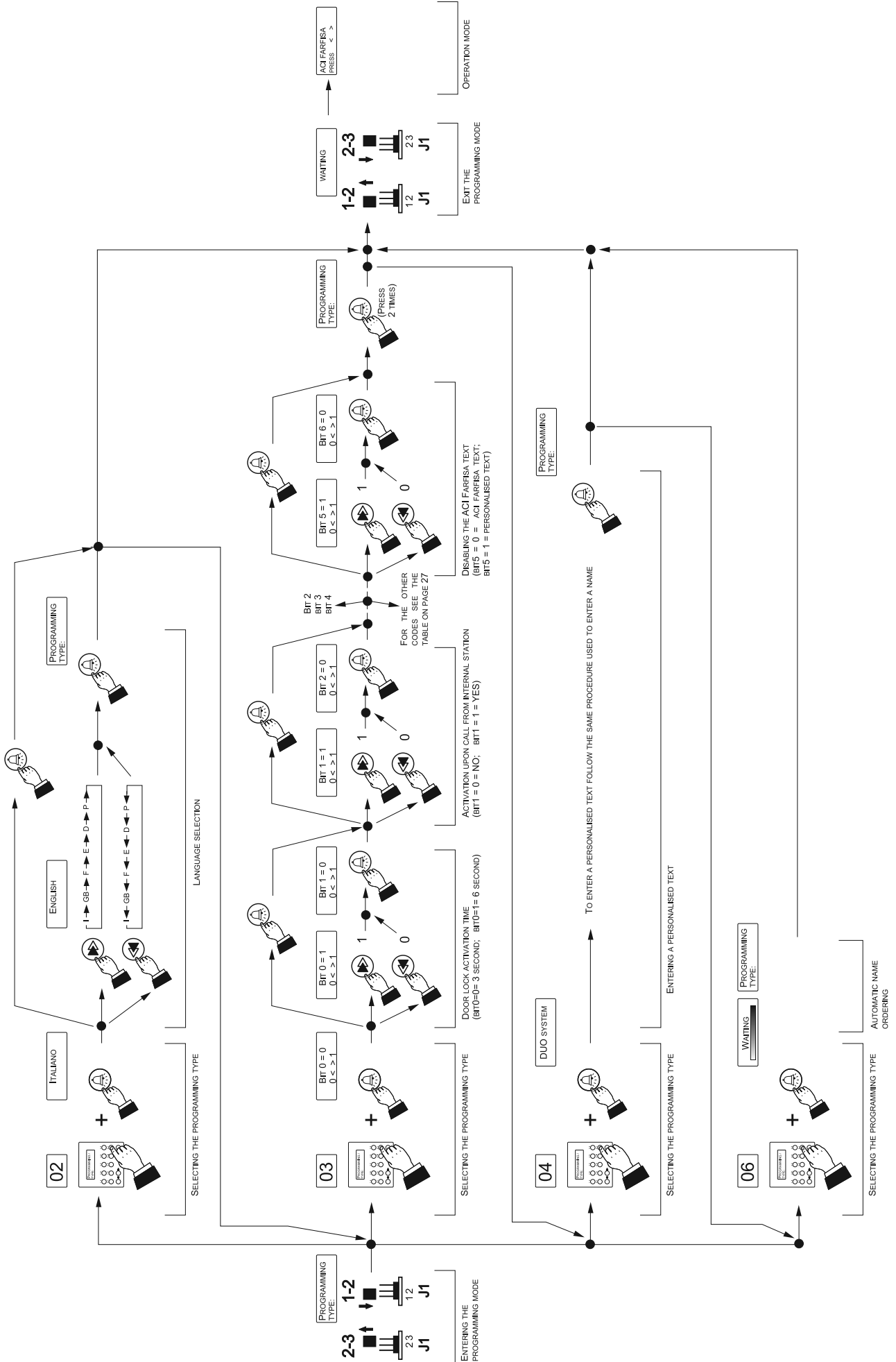


Code 02 - Language selection

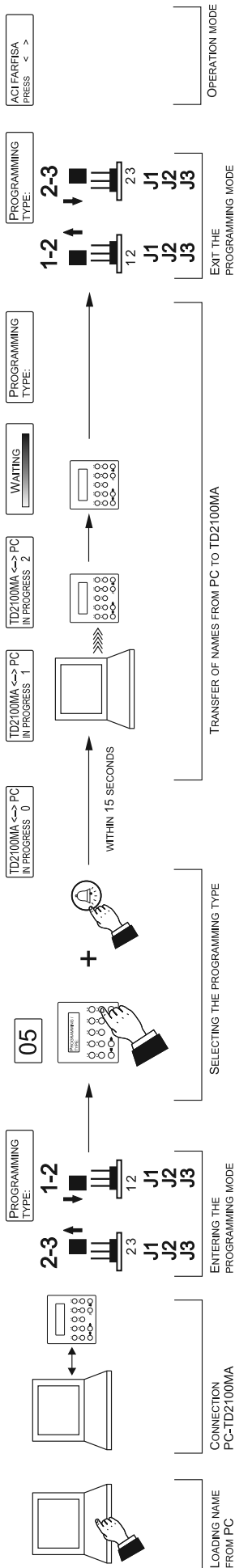
Code 03 - System programming

Code 04 - Personalisation of display initial text

Code 06 - Ordering names



Code 05 - Loading names from Personal Computer



OPERATION

Check that all connections are correct. Connect the power supply unit to the mains; the displays shows the software version of the push-button panel for 3 seconds followed by "ACI/FARFISA /press <> (<> in alternate mode). Dial the user number, check that the number is correct on the display "dialling / ----" and press to make the call. The tone and the text "calling / ----" confirm that the call has been made.

In case of error press **X** (only before sending the call) and dial the correct to number. If the number exists you will hear the confirmation tone; if not, you will hear the busy tone and the display will show "busy / ". You can select the internal station from the names in the list. Press or to search for the internal station and press to send the call.

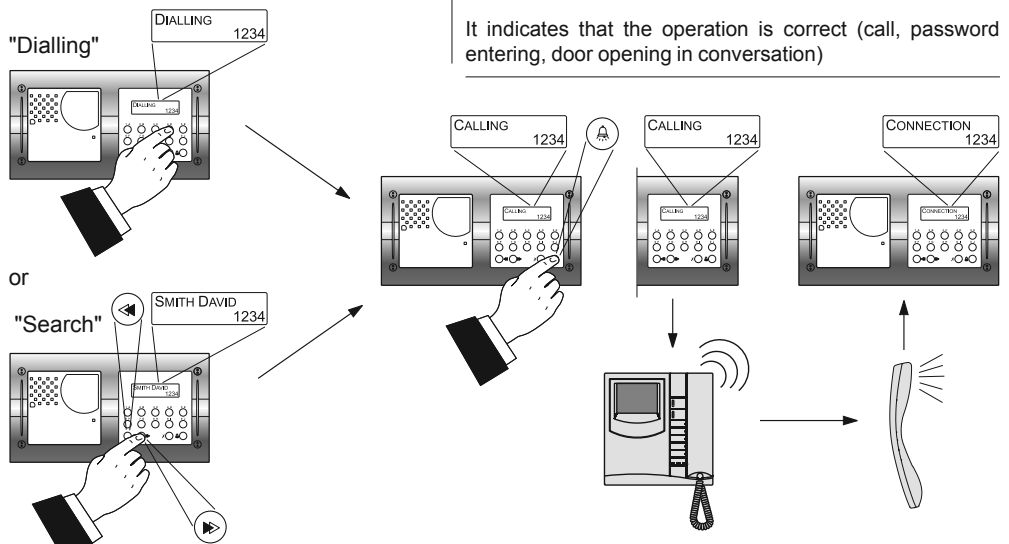
The called station will ring only once; but, if in this phase, press another time the station rings again. If press **X** the call is terminated and the system is ready for a new call.

The called user picks up the handset (or press for Zhero, myLogic and Echos series) enables the conversation with the external station for 90 seconds. The display shows "connection / ----". The text on the display starts flashing 10 seconds before conversation ends. To continue conversation for additional 90 seconds press again.

Press the button to release the door lock. Door lock activation time is 3 seconds (or 6 seconds).

Replace the handset (or press for Zhero, myLogic and Echos series) or press **X** on the door station to restore the idle state. Numbers that are not sent or deleted go off after 25 seconds.

In installations with 2 or more digital push-button panels, when a call is made from one push-button panel, the other push-button panels are deactivated and their display shows "busy / ". Wait until the line is free to make the call.



Door lock opening

The door lock can be opened from the push-button panel, including in "busy" mode, by dialling one of the 16 4-digit codes you have entered.

Door lock activation

- Dial **00**
- Press ; the display shows "Password / ■■■■■"
- Dial the personal access code within 10 seconds; each digit is visualised with \* instead of ■.
- Press to release the door lock; you hear the confirmation tone and the push-button panel returns to the current system operation mode (free or busy).

Tone table

End conversation tone



Indicates an error during the programming phase or that the conversation time is near to expire.

Busy



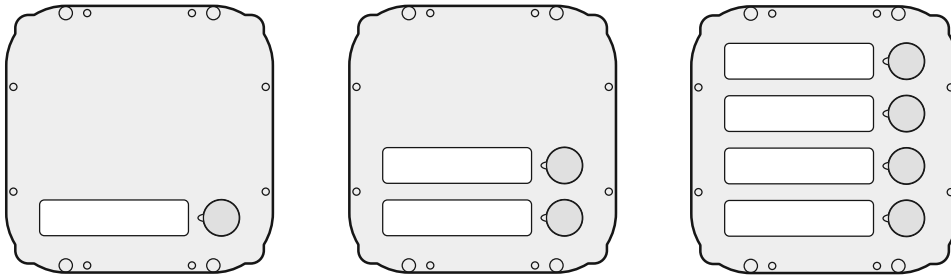
Indicates that the user is busy or not existing

Acknowledge



It indicates that the operation is correct (call, password entering, door opening in conversation)

DIGITAL ENCODER



**CD2131MAS.** Encoding module with front plate and one stainless steel button. Complete with name-holders with transparent screen green backlighting, breaking resistant and with connection cable to the next module. Used to send calls over DUO digital line.

**CD2132MAS.** With 2 call buttons.

**CD2134MAS.** With 4 call buttons.

**Technical features**

Power supply from audio/video module	
Door-opening time	3 / 6 seconds
Number of calls	128
Default address	231
Address 1 <sup>st</sup> push-button (default)	100
Dimensions	1 module
Operating temperature	0°++40°C
Maximum humidity acceptable	90% RH

**Terminals**

<b>LP/LP</b>	audio-data-video to and from internal users
<b>EC</b>	positive signal for auxiliary service
<b>EM</b>	negative signal for auxiliary service
<b>S1/S2</b>	door opening contacts

**PROGRAMMING**

(instruction for article with software **AF100 or higher**)

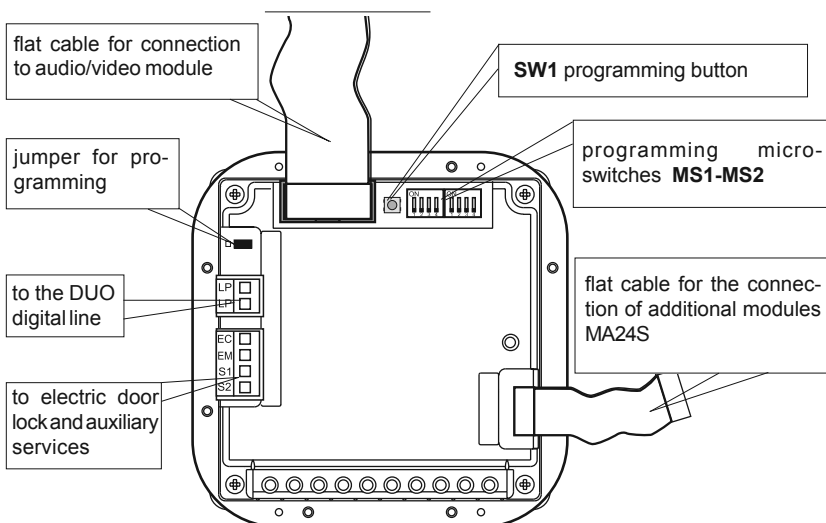
To program the device it is necessary to perform the following phases:

- 1) enter programming mode
- 2) insert code of desired programming
- 3) insert required address or functional code
- 4) exit programming mode

**Notes**

- In any situation it would be possible to exit the programming phase following the instructions reported on paragraph 4.
- To proceed with other programming repeat the phases 2 and 3.

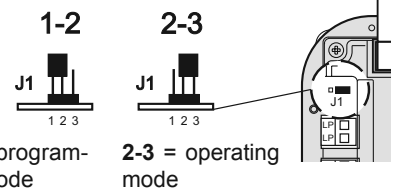
**Connection terminal boards**



**1) ENTERING THE PROGRAMMING MODE**

- Move the jumper **J1** from 2-3 to 1-2 position; a programming tone will confirm the correct operation.

**Position of jumper J1**

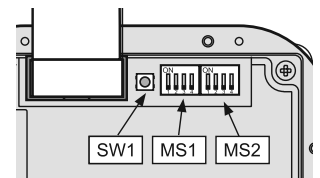


**2) INSERT CODE OF DESIRED PROGRAMMING**

- On the microswitches **MS1** and **MS2** set the code corresponding to the programming operation you wish to enter as reported on table 3.11 on page 3.42 (codes **1A, 2A, 1B, 2B, 1C, 1E** and **AA**).
- Press the programming button **SW1**.

**3) INSERT REQUIRED ADDRESS OR FUNCTIONAL CODE**

- On the microswitches **MS1** and **MS2** set the address you wish to enter in accordance with the cross-references reported on table 3.7 on the pages 3.23, 3.24 and 3.25. For system programming see table 3.12 on the page 3.42 (code **2B**).
- Press the programming button **SW1**.



- Repeat phases 2 and 3 until you have completely programmed the digital encoder.
- Any time you press the **SW1** button an acknowledge or error tone will warning you whether the entered code is correct or not; in case of incorrect code you must enter again the correct one.

**4) EXIT PROGRAMMING MODE**

To exit the programming phase it is necessary to set OFF all the microswitches **MS1** and **MS2** and move back the jumper **J1** from 1-2 to 2-3 position.



**Table 3.11**  
Selection code of the programming

	MS1	MS2	Address or function to be programmed
1A			User address associated to the first button. Codes from 1 to 200 (see table 3.7 of pages 3.23, 3.24 and 3.25). Factory setting 100.
2A*			User address associated to the last button. Codes from 1 to 200 (see table 3.7 on pages 3.23, 3.24 and 3.25). Default value 200.
1B			Address of the external door station. Codes from 231 to 250 (see table 3.7 on page 3.25). Default value 231.
2B			System programming (see table 3.12).
1C			Settings for operations with a door keeper exchanger. Enter address <b>201</b> if the door station operates with 1 or more main door keeper exchangers or the address <b>210</b> if the door station operates with 1 or more secondary doorkeeper exchangers (see table 3.7, page 3.25).
1E			Address associated with terminals EC-EM (see corresponding section for codes to be inserted).
AA			Set the device back to factory settings. Code <b>85</b> (see table 3.7 of page 3.23). <b>Warning:</b> after the reset, 1 and 2 buttons digital encoders will be set to 4 buttons digital encoder factory settings.
<b>Codes used to deactivate the camera upon call of 2 user groups (see page 3.43)</b>			
4E			first address in group 1 (see codes of table 3.7 on pages 3.23, 3.24 and 3.25)
5E			last address in group 1 (see codes of table 3.7 on pages 3.23, 3.24 and 3.25)
6E			first address in group 2 (see codes of table 3.7 on pages 3.23, 3.24 and 3.25)
7E			last address in group 2 (see codes of table 3.7 on pages 3.23, 3.24 and 3.25)

\* This programming is useful when the push button panel has more buttons than the connected users and to prevent the case when, by pressing an enabled button, the system gets busy

**Table 3.12**  
Operating mode of the system (code 2B)

Microswitches	Microswitches position of MS1 and MS2		
	OFF	ON	
MS1 	1	door lock activation time; 3 seconds **	door lock activation time; 6 seconds
	2	deactivation upon call from internal station ***	activation upon call from internal station **
	3	reserved: to leave in position OFF **	
MS2 	4	ACTIVATION of tone generator on the external door station **	DEACTIVATION of tone generator on the external door station
	1-2	reserved: to leave in position OFF **	
	3	ordinary management terminals EC-EM (programming 1E-table 3.11) **	management of terminals EC-EM for additional camera
	4	supplementary door lock activation time; 3 seconds **	supplementary door lock activation time; 6 seconds

\*\* Factory setting.

\*\*\* This function allows the internal stations to press the button or press for Zhero, myLogic and Echos series and pick up the handset, start a conversation with the external station (in case of more external stations in parallel the connection is established with the last calling door station) and activate the door lock by pressing the button .

**EC-EM TERMINALS**

The EC-EM terminals can be used to connect:

- one active relay during the call and for the entire conversation (default)
- one additional camera
- one additional door lock

To have these functions you must connect the terminals correctly and make some programming operations on the push-button panel.

**- Connection of one relay (see fig. 1)**

Programming operations to be made:

- microswitch 3 of MS2 = position OFF
- microswitch 4 of MS2 = position OFF
- code 1E = enter address 255

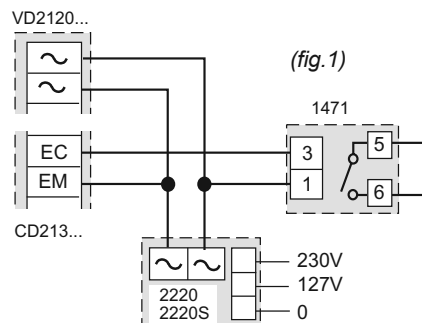
**- Connection of one additional camera**

For this use you must connect the EC and EM terminals to the corresponding terminals of the audio/video module. Programming operations to be made:

- microswitch 3 of MS2 = position ON
- microswitch 4 of MS2 = position OFF
- code 1E = enter address 255

**- Connection of one additional door lock.**

For this use you must connect a relay as shown in the figure and program the push-button panel according to the desired service.



**1) - activation of door lock from turn-ON button of internal stations.** This function can be activated only during a conversation with the external door station. In idle state the buttons will activate the external door station. Programming operations to be made:  
 - microswitch **3** of **MS2** = position **OFF**  
 - microswitch **4** of **MS2** = position **OFF** (3 seconds) or **ON** (6 seconds)  
 - code **1E** = enter address **250**

**2) - activation of door lock from button of internal stations**  
 This programming allows for having two groups of users connected to a single external door station, each of them with its own door lock. The division between the two groups is indicated by the number that is inserted in the programming of code **1E**. You must insert the first user number recognised by group 2 that will activate the door lock connected to terminals EC and EM; all higher numbers will automatically be in group

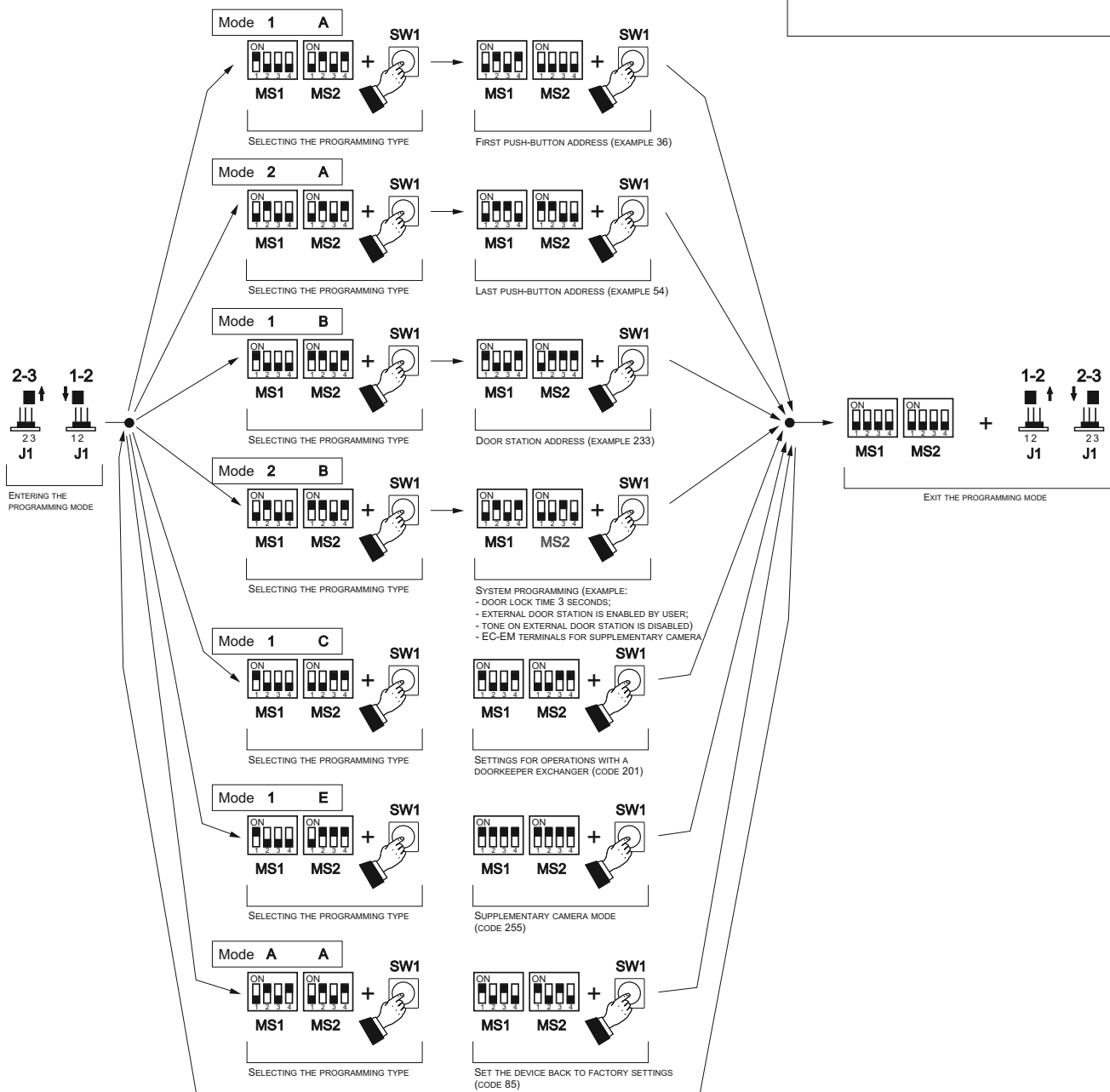
2 and will activate the door lock connected to terminals S1 and S2.  
 Programming operations to be made:  
 - microswitch **3** of **MS2** = position **OFF**  
 - microswitch **4** of **MS2** = position **OFF** (3 seconds) or **ON** (6 seconds)  
 - code **1E** = insert address of **last user in group 1** (example: if you enter 100 you will have: group 1 with codes from 1 to 99; group 2 from 100 to 200).

**How to deactivate the camera upon call**  
 You can create 2 groups of user addresses that will not activate the camera during the call from the external door station. This function is used to avoid the temporary turn-on of white LEDs in the colour camera module during calls to intercoms or actuators 2281.

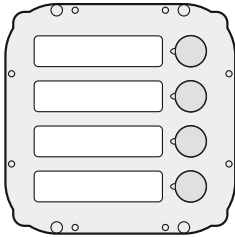
**How to set address groups (codes 4E, 5E, 6E and 7E)**

- enter the programming mode as illustrated in "enter the programming mode";
- set code **4E** in microswitches **MS1** and **MS2** and press button **SW1**; you will hear the confirmation tone;
- set the address number of the first user in group 1 in microswitches **MS1** and **MS2** (see table 3.7 on page 3.23);
- press button **SW1**; you will hear the confirmation tone;
- set code **5E** in microswitches **MS1** and **MS2** and press button **SW1**; you will hear the confirmation tone;
- set the address number of the last user in group 1 and press button **SW1**; you will hear the confirmation tone;
- repeat the operations above to enter the address of the first and last user in group 2 (codes **6E** and **7E**, respectively);
- press button **SW1** to exit the programming mode.

**Example of programming for digital encoders**



**PUSH-BUTTON MODULES WITH INTEGRATED ENCODING**



The button module with integrated encoding board, thanks to the connection to the encoder module CD2131MAS, CD2132MAS or CD2134MAS, allow the calls in DUO systems.

**MAS 24S.**

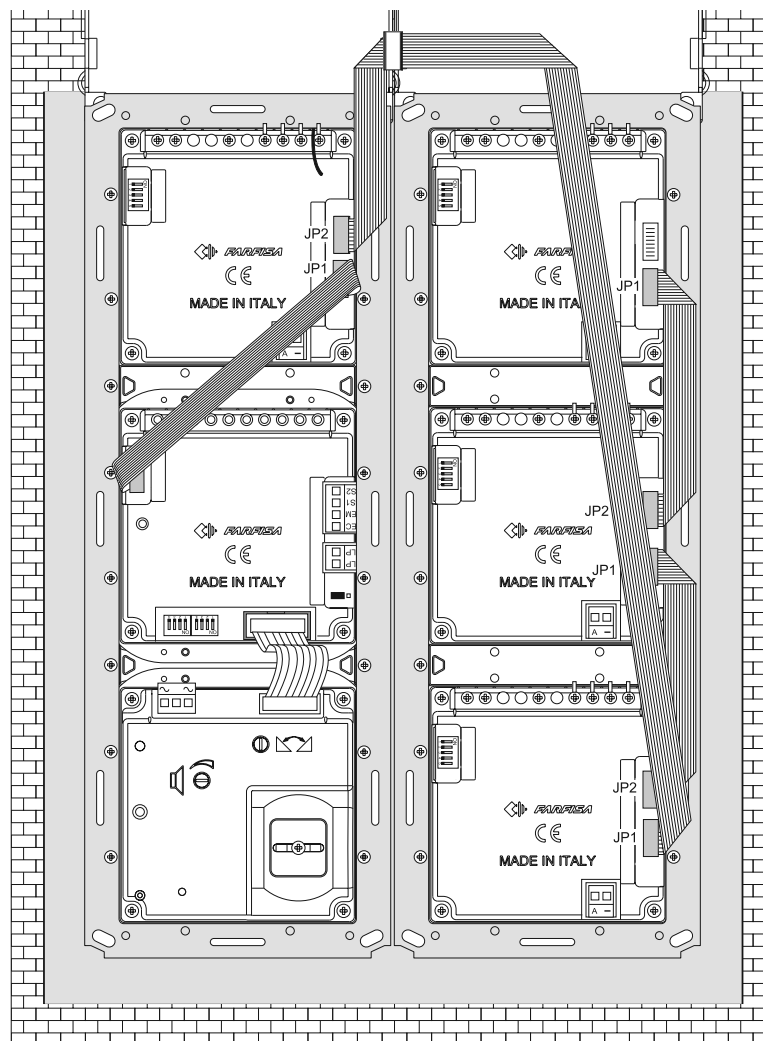
Module with antivandal stainless steel front plate and 4 call buttons. Complete with name holders with transparent screen green back-lighting, resistant to breaking and connection cable to the next module.

**Terminals**

- A** AC or DC power supply input for name-plate Led (13Vac or dc)
- AC power supply or ground input for name-plate Led

**Installation and connections**

- Connect the digital encoder to the connector JP1 of the first MAS24S module using the flat cable supplied with the digital encoder.
- Connect the connector JP2 of the first MAS24S module to the connector JP1 of the second MAS24S module using the flat cable supplied with the product.
- Connect in the same way all the other MAS24S modules.
- Remove the flat cable from the last MAS24S module because it is not used.



**PROGRAMMING**

The microswitches, present on the back of the MAS24S, allow the digital encoder to recognize the code of the connected buttons, consequently they must be programmed properly. The programmed codes must correspond to the addresses of the internal users.

The code set on the microswitches (see table 3.13 on page 3.45) determines the address of the users called by pressing the buttons of the push-button module in a sequence (starting from above) according to the following rule:

**Called User Address (IUC)** by pressing the buttons of the module (MAS24S) = **Address Associated with First Button (IPP)** of the digital encoder (CD2131MAS, CD2132MAS or CD2134MAS) + **Number Associated with Button (NAP)**.

General rule: **IUC = IPP + NAP**

General rule applied to the first example below;

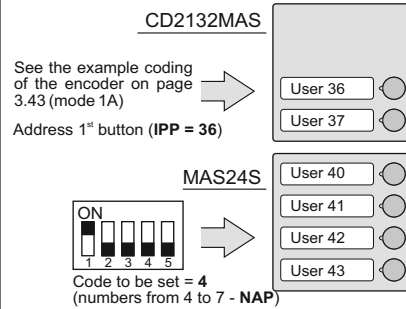
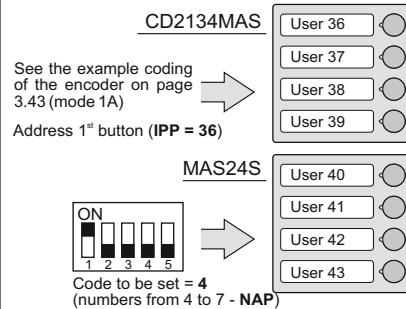
- if you press the first button from above of the MAS24S:

$$36 \text{ (IPP)} + 4 \text{ (1st NAP)} = 40 \text{ (IUC)}$$

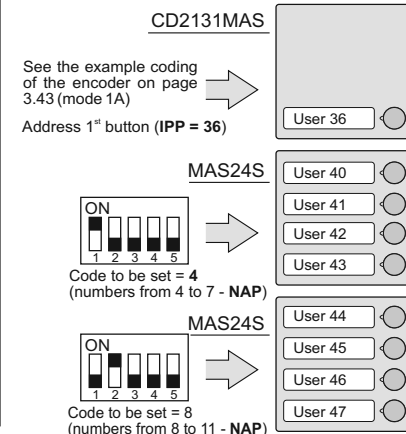
the user with address 40 will be called.

**Examples:**

- If the first button of the digital encoder CD2134MAS is associated with address 36 and code 4 is set on the microswitches of the first button module MAS24S (numbers associated with buttons 4 ÷ 7), starting from up down, the buttons of the MAS24S module will call the users with address 40, 41, 42 and 43.



- Addresses 38 and 39 will be lost when using the CD2132MAS digital encoder and the art.MAS24S as first push-button module.



- Addresses 37, 38 and 39 will be lost when using the CD2131MAS digital encoder and the MAS24S as first push-button module.

Table 3.13

Example of order used to associate numbers with buttons

MAS24S			Code to be set	Numbers associated with buttons- NAP	Push-button microswitch
1° NAP					
2° NAP					
3° NAP					
4° NAP					
Code to be set	Numbers associated with buttons- NAP	Push-button microswitch			
4	1 <sup>st</sup> NAP = 4 2 <sup>nd</sup> NAP = 5 3 <sup>rd</sup> NAP = 6 4 <sup>th</sup> NAP = 7		60	1 <sup>st</sup> NAP = 60 2 <sup>nd</sup> NAP = 61 3 <sup>rd</sup> NAP = 62 4 <sup>th</sup> NAP = 63	
8	1 <sup>st</sup> NAP = 8 2 <sup>nd</sup> NAP = 9 3 <sup>rd</sup> NAP = 10 4 <sup>th</sup> NAP = 11		64	1 <sup>st</sup> NAP = 64 2 <sup>nd</sup> NAP = 65 3 <sup>rd</sup> NAP = 66 4 <sup>th</sup> NAP = 67	
12	1 <sup>st</sup> NAP = 12 2 <sup>nd</sup> NAP = 13 3 <sup>rd</sup> NAP = 14 4 <sup>th</sup> NAP = 15		68	1 <sup>st</sup> NAP = 68 2 <sup>nd</sup> NAP = 69 3 <sup>rd</sup> NAP = 70 4 <sup>th</sup> NAP = 71	
16	1 <sup>st</sup> NAP = 16 2 <sup>nd</sup> NAP = 17 3 <sup>rd</sup> NAP = 18 4 <sup>th</sup> NAP = 19		72	1 <sup>st</sup> NAP = 72 2 <sup>nd</sup> NAP = 73 3 <sup>rd</sup> NAP = 74 4 <sup>th</sup> NAP = 75	
20	1 <sup>st</sup> NAP = 20 2 <sup>nd</sup> NAP = 21 3 <sup>rd</sup> NAP = 22 4 <sup>th</sup> NAP = 23		76	1 <sup>st</sup> NAP = 76 2 <sup>nd</sup> NAP = 77 3 <sup>rd</sup> NAP = 78 4 <sup>th</sup> NAP = 79	
24	1 <sup>st</sup> NAP = 24 2 <sup>nd</sup> NAP = 25 3 <sup>rd</sup> NAP = 26 4 <sup>th</sup> NAP = 27		80	1 <sup>st</sup> NAP = 80 2 <sup>nd</sup> NAP = 81 3 <sup>rd</sup> NAP = 82 4 <sup>th</sup> NAP = 83	
28	1 <sup>st</sup> NAP = 28 2 <sup>nd</sup> NAP = 29 3 <sup>rd</sup> NAP = 30 4 <sup>th</sup> NAP = 31		84	1 <sup>st</sup> NAP = 84 2 <sup>nd</sup> NAP = 85 3 <sup>rd</sup> NAP = 86 4 <sup>th</sup> NAP = 87	
32	1 <sup>st</sup> NAP = 32 2 <sup>nd</sup> NAP = 33 3 <sup>rd</sup> NAP = 34 4 <sup>th</sup> NAP = 35		88	1 <sup>st</sup> NAP = 88 2 <sup>nd</sup> NAP = 89 3 <sup>rd</sup> NAP = 90 4 <sup>th</sup> NAP = 91	
36	1 <sup>st</sup> NAP = 36 2 <sup>nd</sup> NAP = 37 3 <sup>rd</sup> NAP = 38 4 <sup>th</sup> NAP = 39		92	1 <sup>st</sup> NAP = 92 2 <sup>nd</sup> NAP = 93 3 <sup>rd</sup> NAP = 94 4 <sup>th</sup> NAP = 95	
40	1 <sup>st</sup> NAP = 40 2 <sup>nd</sup> NAP = 41 3 <sup>rd</sup> NAP = 42 4 <sup>th</sup> NAP = 43		96	1 <sup>st</sup> NAP = 96 2 <sup>nd</sup> NAP = 97 3 <sup>rd</sup> NAP = 98 4 <sup>th</sup> NAP = 99	
44	1 <sup>st</sup> NAP = 44 2 <sup>nd</sup> NAP = 45 3 <sup>rd</sup> NAP = 46 4 <sup>th</sup> NAP = 47		100	1 <sup>st</sup> NAP = 100 2 <sup>nd</sup> NAP = 101 3 <sup>rd</sup> NAP = 102 4 <sup>th</sup> NAP = 103	
48	1 <sup>st</sup> NAP = 48 2 <sup>nd</sup> NAP = 49 3 <sup>rd</sup> NAP = 50 4 <sup>th</sup> NAP = 51		104	1 <sup>st</sup> NAP = 104 2 <sup>nd</sup> NAP = 105 3 <sup>rd</sup> NAP = 106 4 <sup>th</sup> NAP = 107	
52	1 <sup>st</sup> NAP = 52 2 <sup>nd</sup> NAP = 53 3 <sup>rd</sup> NAP = 54 4 <sup>th</sup> NAP = 55		108	1 <sup>st</sup> NAP = 108 2 <sup>nd</sup> NAP = 109 3 <sup>rd</sup> NAP = 110 4 <sup>th</sup> NAP = 111	
56	1 <sup>st</sup> NAP = 56 2 <sup>nd</sup> NAP = 57 3 <sup>rd</sup> NAP = 58 4 <sup>th</sup> NAP = 59		112	1 <sup>st</sup> NAP = 112 2 <sup>nd</sup> NAP = 113 3 <sup>rd</sup> NAP = 114 4 <sup>th</sup> NAP = 115	
			116	1 <sup>st</sup> NAP = 116 2 <sup>nd</sup> NAP = 117 3 <sup>rd</sup> NAP = 118 4 <sup>th</sup> NAP = 119	
			120	1 <sup>st</sup> NAP = 120 2 <sup>nd</sup> NAP = 121 3 <sup>rd</sup> NAP = 122 4 <sup>th</sup> NAP = 123	
			124	1 <sup>st</sup> NAP = 124 2 <sup>nd</sup> NAP = 125 3 <sup>rd</sup> NAP = 126 4 <sup>th</sup> NAP = 127	

OPERATION

Check that all the connections are correct. Connect the power supply unit to the mains.

To make a call press the button corresponding to the desired user. Call is confirmed by an acknowledge tone, if the communication line is available, or denied by a busy tone if the communication line is not available (see tone table).

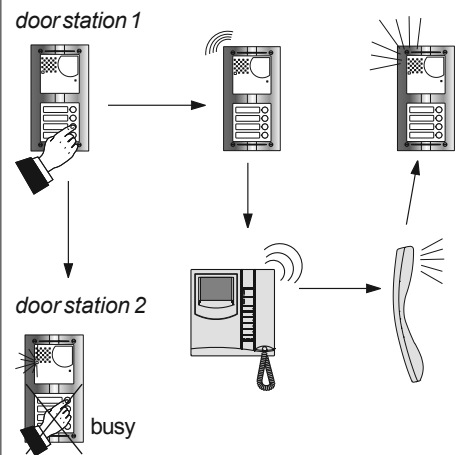
Called equipment rings only once, but if in this phase the same calling button on the external station is pressed again the equipment will ring another time.

The called user picks up the handset (or press for Zhero, myLogic and Echos series) enables the conversation with the external station for 90 seconds.

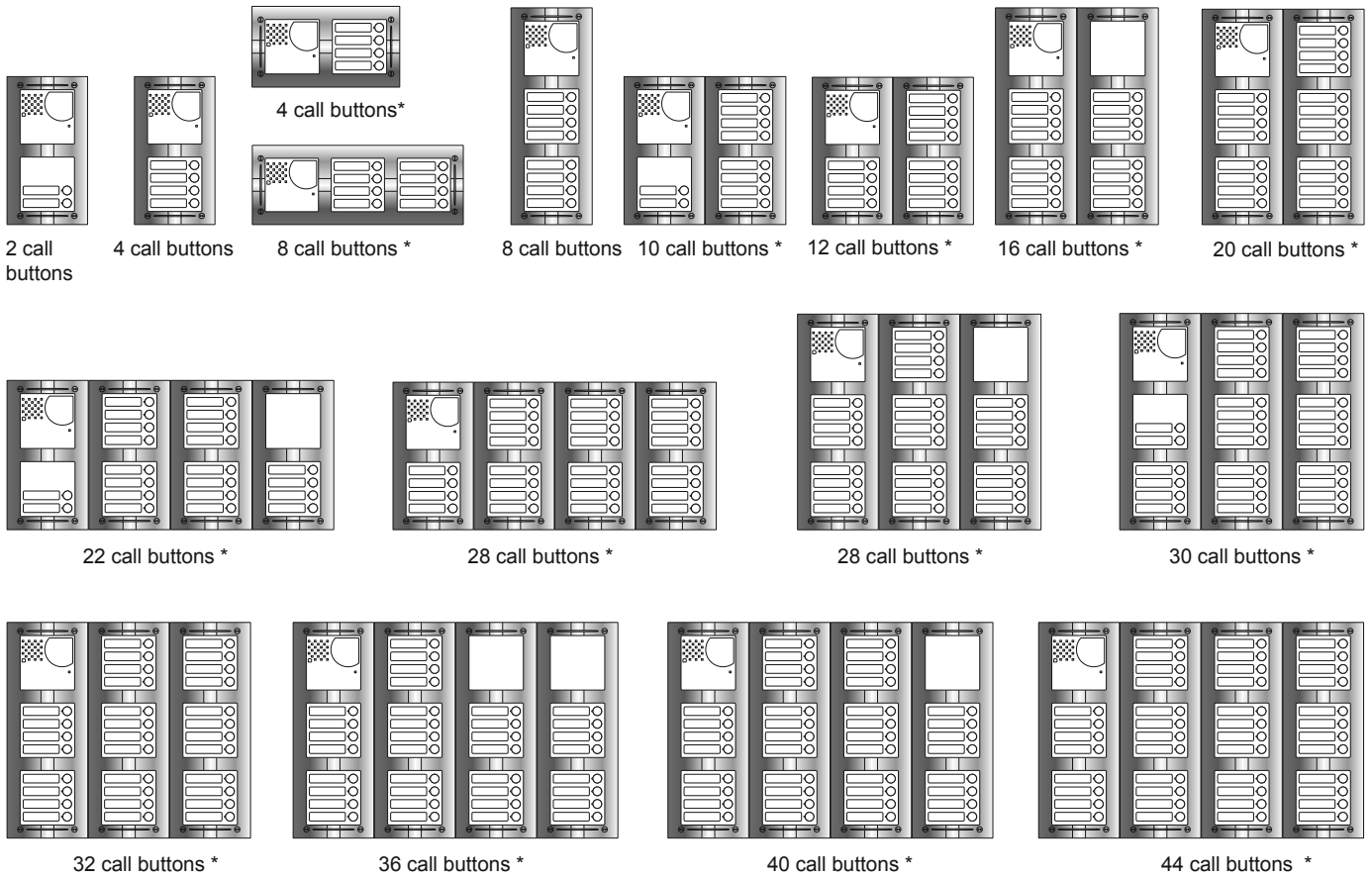
A tone will advise the user 10 seconds before the conversation ends. To continue conversation for additional 90 seconds on the external station the calling button must be pressed again. Press the button to release the door lock. Door lock activation time is 3 seconds (or 6 seconds according to the system programming).

Replace the handset (or press for Zhero, myLogic and Echos series) to end the conversation and restore the idle state.

In installations with 2 or more external door stations when a call is made from one push-button panel, the other push-button panel are deactivated with a busy indication (red LED flashing on the audio or audio/video module). Wait until the line is free to make a call.



Examples of installations in videointercom systems



\* rain shelters cannot be used in these compositions

Composition board of push-button panels.

Nr calls	Dimensions	Encoder module	Camera and speaker mod.	Button module and blank module	Front frames	Back boxes and mod. frame	Rain shelters
2	140x256x19 (5 1/2" x 10 1/16" x 3/4")	1 CD2132MAS	1 VD2120CMAS	- -	1 MAS62	1 MA72	1 MA92
4		1 CD2134MAS	1 VD2120CMAS	- -	1 MAS62	1 MA72	1 MA92
6	140x374x19 (5 1/2" x 14 3/4" x 3/4")	1 CD2132MAS	1 VD2120CMAS	1 MAS24S -	1 MAS63	1 MA73	1 MA93
8		1 CD2134MAS	1 VD2120CMAS	1 MAS24S -	1 MAS63	1 MA73	1 MA93
9	280x256x19 (11" x 10 1/16" x 3/4")	1 CD2132MAS	1 VD2120CMAS	2 MAS24S -	2 MAS62	2 MA72	-
12		1 CD2134MAS	1 VD2120CMAS	2 MAS24S -	2 MAS62	2 MA72	-
14	280x374x19 (11" x 14 3/4" x 3/4")	1 CD2132MAS	1 VD2120CMAS	3 MAS24S 1 MAS20	2 MAS63	2 MA73	-
17		1 CD2131MAS	1 VD2120CMAS	4 MAS24S -	2 MAS63	2 MA73	-
20		1 CD2134MAS	1 VD2120CMAS	4 MAS24S -	2 MAS63	2 MA73	-
22	560x256x19 (22 1/16" x 10 1/16" x 3/4")	1 CD2132MAS	1 VD2120CMAS	5 MAS24S 1 MAS20	4 MAS62	4 MA72	-
25		1 CD2131MAS	1 VD2120CMAS	6 MAS24S -	4 MAS62	4 MA72	-
28		1 CD2134MAS	1 VD2120CMAS	6 MAS24S -	4 MAS62	4 MA72	-
29	420x374x19 (16 3/16" x 14 3/4" x 3/4")	1 CD2132MAS	1 VD2120CMAS	7 MAS24S -	3 MAS63	3 MA73	-
30		1 CD2132MAS	1 VD2120CMAS	7 MAS24S -	3 MAS63	3 MA73	-
32		1 CD2134MAS	1 VD2120CMAS	7 MAS24S -	3 MAS63	3 MA73	-
36		1 CD2134MAS	1 VD2120CMAS	8 MAS24S 2 MAS20	4 MAS63	4 MA73	-
37		1 CD2131MAS	1 VD2120CMAS	9 MAS24S 1 MAS20	4 MAS63	4 MA73	-
38	560x374x19 (22 1/16" x 14 3/4" x 3/4")	1 CD2132MAS	1 VD2120CMAS	9 MAS24S 1 MAS20	4 MAS63	4 MA73	-
40		1 CD2134MAS	1 VD2120CMAS	9 MAS24S 1 MAS20	4 MAS63	4 MA73	-
41		1 CD2131MAS	1 VD2120CMAS	10 MAS24S -	4 MAS63	4 MA73	-
44		1 CD2134MAS	1 VD2120CMAS	10 MAS24S -	4 MAS63	4 MA73	-

- For intercom installations replace art. VD2120MAS with AD2110MAS

It replaces MA72 or MA73

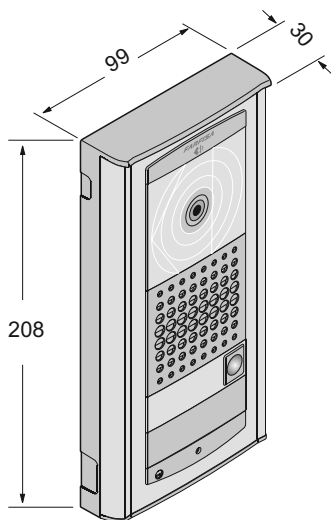


## Chapter 3A

### POWERED FROM THE BUS EXTERNAL STATIONS

	<i>Page</i>
<b>AGORA' series</b>	<b>3A.2</b>
- Adjustments	3A.3
- Installation	3A.4
- Programming	3A.5
- Operation	3A.6
<b>SOLVO series</b>	<b>3A.7</b>
- Adjustments	3A.8
- Installation	3A.9
- Programming	3A.10
- USB connection	3A.15
- Operation	3A.15
- Rain shelter 290S/0	3A.16
<b>ALBA series</b>	<b>3A.17</b>
- LED signals and adjustments	3A.20
- Installation	3A.22
- Programming	3A.27
- Examples and composition boards	3A.33
- Operation	3A.36
- Flush mounted version	3A.37

Powered from the bus one / two way pushbutton panel with reduced dimensions in width and depth. Assembly is quick and easy being flush mounted. The front plate is made of anodized extruded aluminum. The nameplates are backlit with white LEDs for better reading even in low light situations. The reduced size makes it easy to install on the columns of the gates. Available in the "Light" version (light gray)



**VD2101AGL**

Powered from the bus video door station with colour camera and door speaker .

**Technical data**

Power supply from the DUO line	
Stand-by current	16mA
Operating current	0.35A
Door lock activation time	max. 10 s.
Minimum lighting	0.5Lux
LED's camera	4 (white)
LED signaling	1 (red)
Sensor	CMOS 1/3" colour
Number of pixel	440,000
Lens	3.7mm
Focusing	0.6m ÷ ¥
Horizontal/vertical sweep	±10°
Operating temperature	-10°++40°C
Max. permissible humidity	80%RH

**Terminals**

- S+/S-** Electric door lock
- PB/GN** Door release push-button
- LP/LP** Audio-data-video to/from internal users

**AD2101AGL**

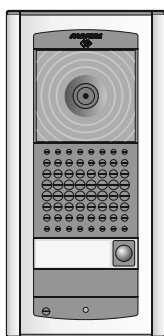
Powered from the bus audio door station with door speaker.

**Technical data**

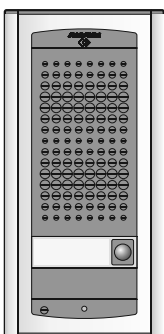
Power supply from the DUO line	
Stand-by current	16mA
Operating current	0.26A
Door lock activation time	max. 10 s
LED signaling	1 (red)
Operating temperature	-10°++40°C
Max. permissible humidity	80%RH

**Terminals**

- S+/S-** Electric door lock
- PB/GN** Door release push-button
- LP/LP** Audio-data to/from internal users



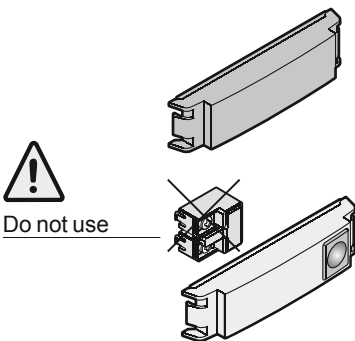
**VD2101AGL. Powerwd from the bus video door station** in light grey version composed of an ABS box for surface mounting, front plate in aluminium with 1 call button and electronic board with colour camera, amplified door speaker and LED's for lighting the nameplates. You can add an additional **AGL21** call button.



**AD2101AGL. Powerwd from the bus audio door station** in light grey version composed of an ABS box for surface mounting, front plate in aluminium with 1 call button and electronic board with amplified door speaker and LED's for lighting the nameplates. You can add an additional **AGL21** call button.

**AGL20.** Blank module. Light grey version.

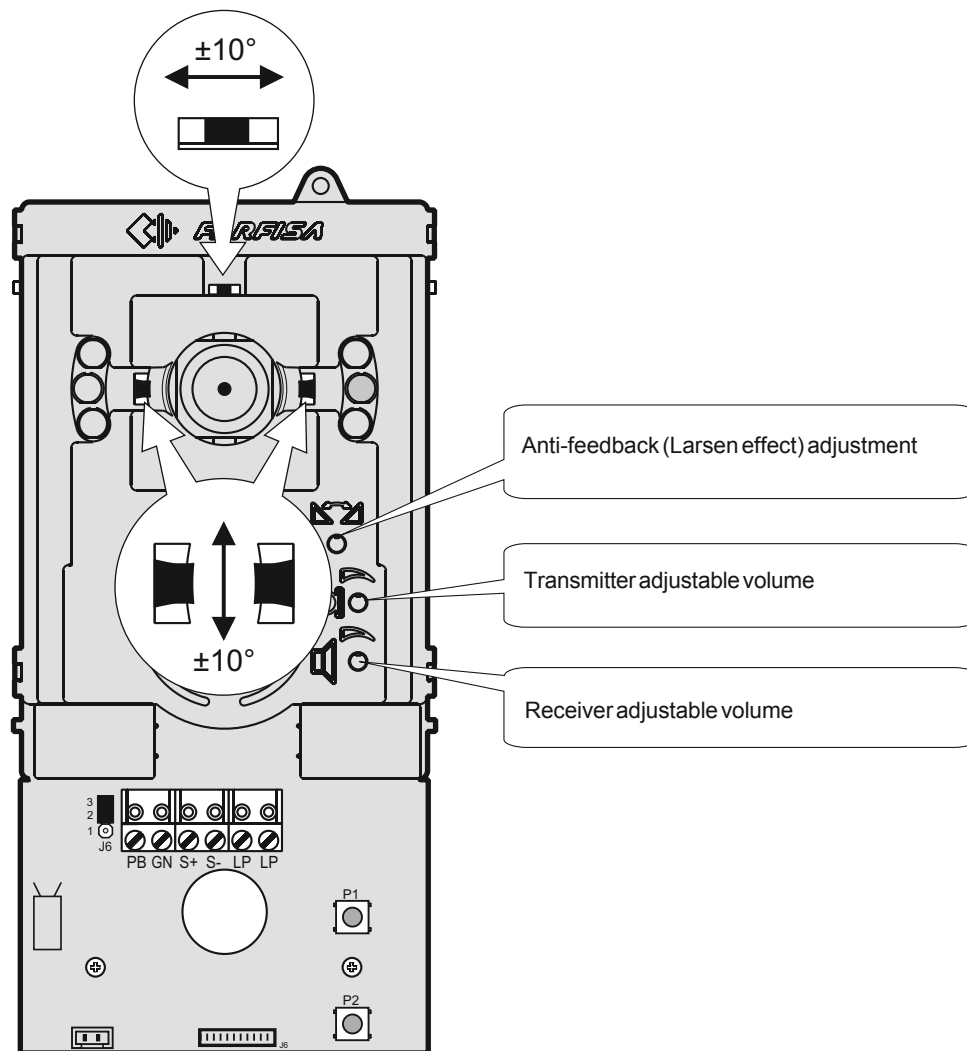
**AGL21.** Single button module with name plate holder. Light grey version.



## Adjustments

### Sweeps (only VD2101AGL)

If necessary, you can manually change the camera framing by adjusting the horizontal and vertical levers in the desired direction (see figure).



### Volumes adjustment

To adjust the volume of microphone and loudspeaker, turn the trimmers and .

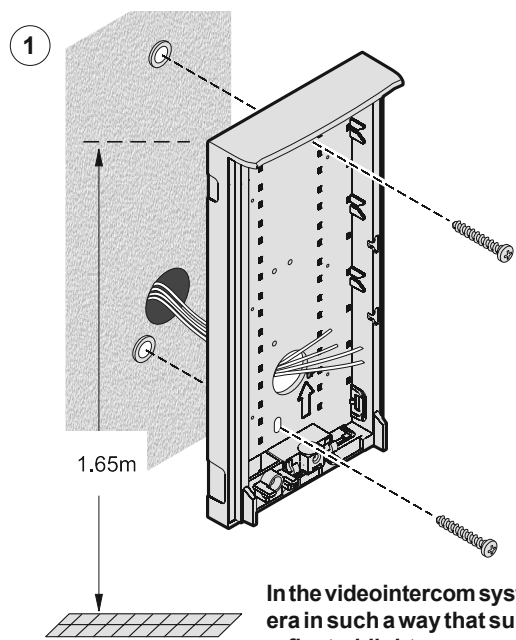
### Anti-feedback adjustment (Antilocale)

In case of "feedback" (Larsen effect) in the external unit it is necessary to operate as follow:

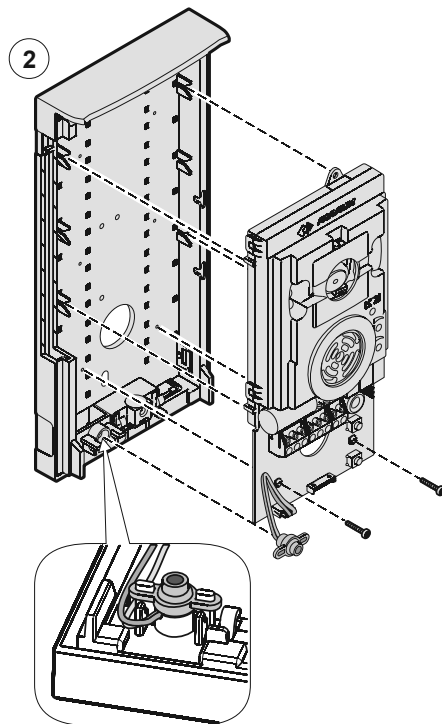
- make the call from the door station and lift the handset of the called user;
- remove the microphone from its housing inside the push-button panel, place it on the loudspeaker of the electric door answering system and adjust the until the feedback stops;
- replace the microphone in its housing.

INSTALLATION

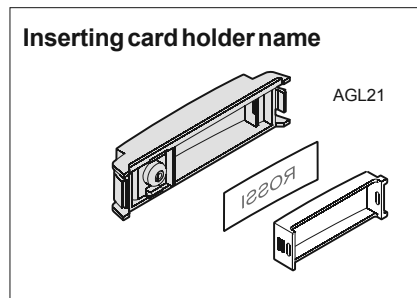
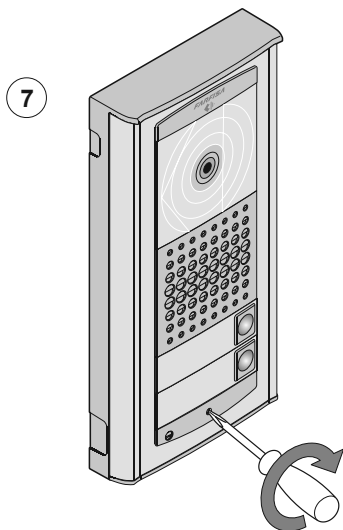
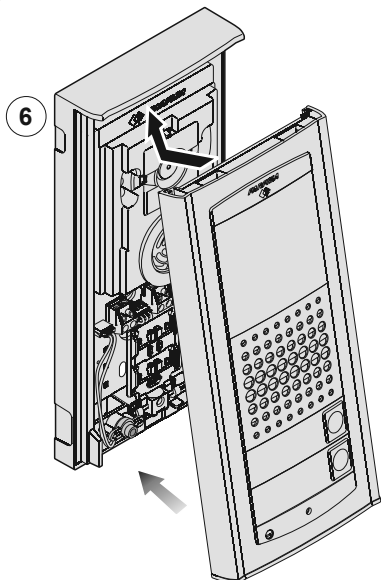
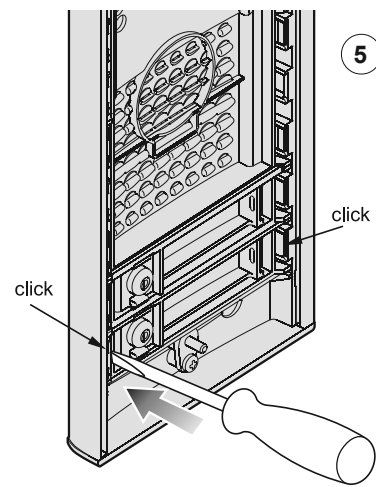
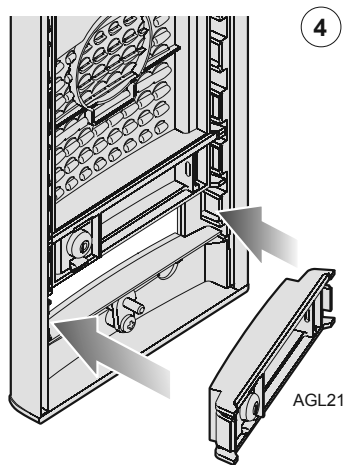
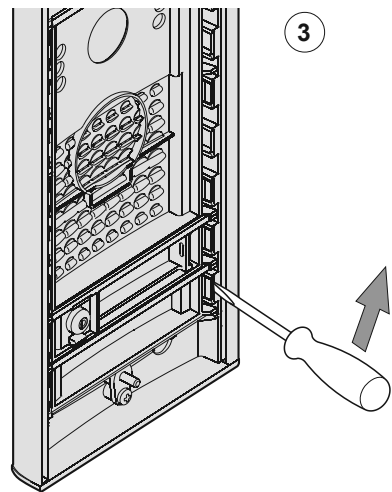
ASSEMBLING DOOR STATIONS VD2101AGL E AD2101AGL



In the videointercom systems, position the camera in such a way that sunlight or other direct or reflected light sources with high intensity do not hit the camera lens.



Application of second additional button on external plate



**PROGRAMMING**

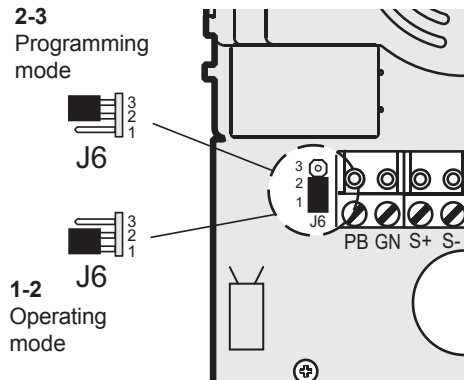
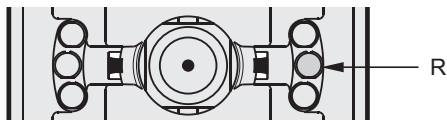
Following is a list of default settings. If necessary, follow the instructions contained in the next chapters to change them.

**Factory setting**

- External Door Station Address = **231**
- Address associated with **P1** button = **100**
- Address associated with **P2** button = **101**
- Lock actuation time = **1 second**

**Entering the programming mode**

- Remove the plate.
- Move the jumper **J6** from position **1-2** to **2-3**; you hear the programming tone and the red LED turn ON (R).



**Exit the programming mode**

To exit the programming mode, you must bring the jumper **J6** from position **2-3** back to position **1-2**.

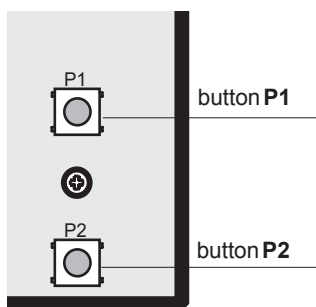
**Using the push-buttons for programming**

Press button "P1" and "P2" to enter addresses or codes.

**Pn:** Press this button to **confirm code programming** or **go to the next programming step**.

**P1:** Press this button to **increase the value you want to enter**. Press the button for a number of times equal to the digit you want to enter (digit 1 = 1 time; digit 9 = 9 times; digit 0 = press "P2" 10 times).

The pressure of the "P2" button is confirmed by an acoustic tone on the loudspeaker.



**Entering codes or addresses**

- Codes and/or addresses must have three digits (hundreds, tens, units); codes and/or addresses with tens and units or units only must be completed by adding zeros. For example, address 96 becomes 096 and address 5 becomes 005.
- Enter one digit at a time by pressing the "P2" button for a number of times "n", where "n" is the value of the digit you want to enter, followed by a pause of about 2 seconds before you go to the next digit (a tone on the loudspeaker will tell you when to go to the next digit). The maximum value you can enter is 255. For example, to enter code 096 you must:
  - press the "P2" button 10 times to enter digit 0 and wait for 2 seconds until you hear a tone in the loudspeaker.
  - press the "P2" button 9 times to enter digit 9 and wait for 2 seconds until you hear a tone on the loudspeaker.
  - press the "P2" button 6 times to enter digit 6 and wait for 2 seconds until you hear a tone on the loudspeaker.

**Note:** - remember to confirm the codes you have entered as explained in the programming chapters.

Table 1. Programming codes	
<b>111</b>	External Door Station address
<b>112</b>	P1 button address
<b>113</b>	P2 button address
<b>114</b>	Door lock activation time
<b>142</b>	Operation with door keeper exchangers
<b>121</b>	Enable/disable free tone
<b>000</b>	Back to factory settings
<b>151-158</b>	Additional associated cameras
<b>159</b>	Main camera

**Programming procedure**

To make the programming it necessary to:

- a) **enter the programming mode** following the instructions described in "Entering the programming mode";
- b) **enter the three digits of the programming code you want to change** following the instructions contained in "Entering codes or address"; **press P1 to confirm:** you hear the confirmation tone and the red LED start flashing.
- c) **make the operations described in the specific programming chapter.**
- d) **continue** with another programming operation or exit moving the jumper **J6** from 2-3 to 1-2.

**111. Entering the External Door Station address**

In this mode you can code the external door station address with codes from 231 to 250 (default is 231).

- **Enter the programming mode** following the instructions described in "Entering the programming mode";
- Enter code **111** and press **P1**; you hear a confirmation tone and the red LED start flashing.
- Dial the code number you have chosen for the external door station and press **P1** to confirm; you hear the confirmation tone and the red LED go back ON without flashing.

- Continue by entering the code of a new programming or exit the programming mode by moving the jumper **J6** to position **1-2**.

**112. Entering the P1 Button address.** The **P1** button is coded by default with address 100; if you want to change it, you must:

- **enter the programming mode** following the instructions described in "Entering the programming mode";
- enter code **112** and press **P1**; you hear a confirmation tone and the red LED start flashing;
- dial the address you want to assign to **P1**. Extensions must be coded with numbers from 001 to 200;
- press **P1**; you hear a confirmation tone and the red LED go back ON without flashing;
- continue by entering the code of a new programming or exit the programming mode by moving the jumper **J6** to position **1-2**.

**113. Entering the P2 Button address.** The **P2** button is coded by default with address 101; if you want to change it, you must:

- **enter the programming mode** following the instructions described in "Entering the programming mode";
- enter code **113** and press **P1**; you hear a confirmation tone and the red LED start flashing;
- dial the address you want to assign to **P2**. Extensions must be coded with numbers from 001 to 200;
- continue by entering the code of a new programming or exit the programming mode by moving the jumper **J6** to position **1-2**.

**114. Lock actuation time.** To change the lock actuation time (max. 10 seconds), you must:

- **enter the programming mode** following the instructions described in "Entering the programming mode";
- enter code **114** and press **P1**; you hear a confirmation tone and the red LED start flashing;
- dial the number of seconds you want the door lock to stay ON (3 digits from 001 to 010);
- press **P1**; you hear a confirmation tone and the red LED go back ON without flashing;
- continue by entering the code of a new programming or exit the programming mode by moving the jumper **J6** to position **1-2**.

**142. Operations with main or secondary door keeper exchangers.**

The following settings are necessary if in the system are installed main and/or secondary door keeper exchangers.

- To make the programming you must:
- **enter the programming mode** following the instructions described in "Entering the programming mode";

- enter code **142** and press **P1**; you hear a confirmation tone and the red LED start flashing;
- enter address **201** if the door station operates with 1 or more main door keeper exchangers or address **210** if the door station operates with 1 or more secondary door keeper exchangers;
- press **P1**; you hear a confirmation tone and the red LED go back ON without flashing;
- continue by entering the code of a new programming or exit the programming mode by moving the jumper **J6** to position **1-2**.

**121. Enable/disable call control tone (free tone).** The following programming is necessary if you want to receive the free tone on the outdoor station when sending the call.

To carry out the programming it is necessary to:

- enter the programming mode following the instructions described in "Entering the programming mode";
- enter code **121** and press **P1**; you hear a confirmation tone and the red LED start flashing;
- enter code **004** if you want to disable the tone or **000** to enable;
- press **P1**; you hear a confirmation tone and the red LED go back ON without flashing;
- continue by entering the code of a new programming or exit the programming mode by moving the jumper **J6** to position **1-2**.

### 000. Resetting default settings

After you have entered the programming mode as described in the corresponding chapter, you must:

- dial **000** following the instructions contained in "entering codes or addresses";
- press **P1**; you hear a confirmation tone and the red LED start flashing;
- dial **123** following the instructions contained in "entering codes or addresses";
- press **P1**; you hear a confirmation tone and the white LEDs of the camera start flashing;
- exit the programming mode moving the jumper **J6** from 2-3 to position **1-2**.

**Warning.** After you have carried out this procedure all programming settings will be reset to the default values.

**151. Presence of the first additional camera associated with the external unit.** The VD2101AGL and AD2101AGL modules can manage external video modulators (such as VM2521) to which up to eight additional cameras can be connected. In the presence of additional cameras, the addresses of the video modulators present in the installation must be programmed and, if necessary, the address of the main camera. To program the address of the first additional camera (VM1):

- enter the programming mode following the instructions described in "Entering the programming mode";
- enter code **151** and press **P1**; you hear a confirmation tone and the red LED start flashing;
- enter the address of the first additional camera (the addresses of the additional cameras must be the same stored in the video modulators to which the cameras are connected and must be selected from those reserved for the external stations: **231 to 253**);
- press **P1**; you hear a confirmation tone and the red LED go back ON without flashing;
- continue by entering the code of a new programming or exit the programming mode by moving the jumper **J6** to position **1-2**.

### 152-158. Addition of VM2-VM8 cameras.

To program the addresses of the VM2 - VM8 cameras, proceed as described in the previous paragraph.


**159. Selection of the main camera.** The main camera (TP) is the camera from which the audio-video module starts the cyclic scan of the cameras associated with it.

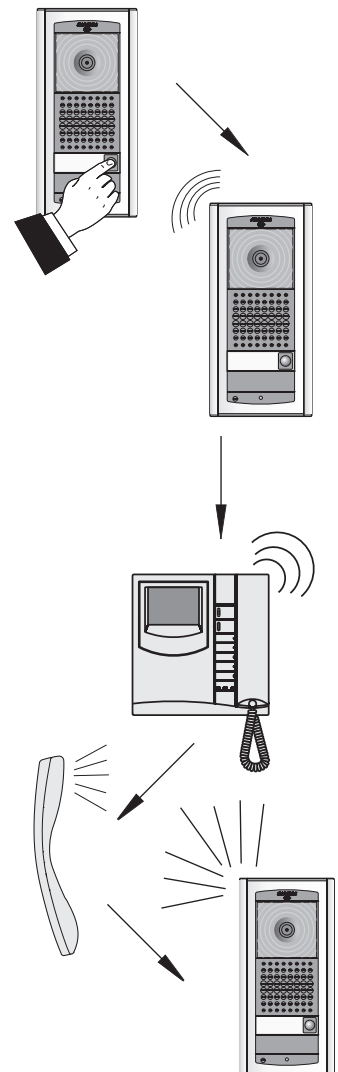
To select which camera to start scanning from:

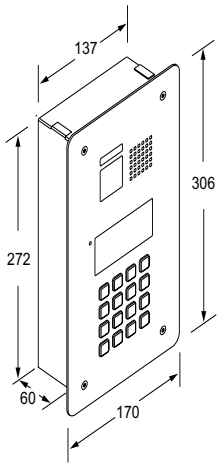
- enter the programming mode following the instructions described in "Entering the programming mode";
- enter code **159** and press **P1**; you hear a confirmation tone and the red LED start flashing;
- dial the address of the main camera (the one from which the cyclic display sequence starts) chosen among the previously programmed VM1 ÷ VM8 addresses. If the main camera must be the one on board the audio-video module (factory programming), the address to be memorized is 255;
- press **P1**; you hear a confirmation tone and the red LED go back ON without flashing;
- continue by entering the code of a new programming or exit the programming mode by moving the jumper **J6** to position **1-2**.

## OPERATION

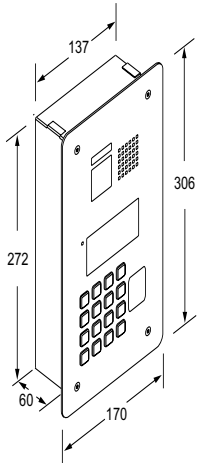
Check that all the connections of the system are correct. Connect the power supply unit to the mains.

To make a call press the button corresponding to the desired user. Call is confirmed by an acknowledge tone, if the communication line is available, or denied by a busy tone and flashing red LEDs if the communication line is not available. Called equipment rings only once, but if in this phase the same calling button on the external station is pressed again the equipment will ring another time. The called user picks up the handset and enables the conversation with the external station for 90 seconds. A tone will advise the user 10 seconds before the conversation ends. To continue conversation for additional 90 seconds on the external station the calling button must be pressed again. Press the  button to release the door lock. Door lock activation time depends to the choosing programming time (code 114). Replace the handset to end the conversation.

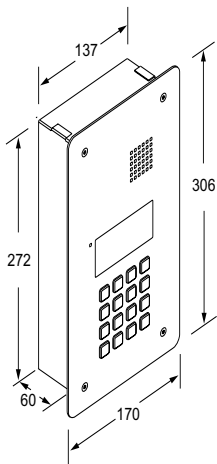




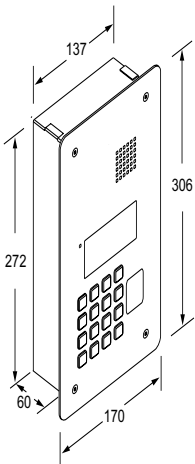
**TD2000** Solvo series digital video entry panel, for Duo digital system. A single element complete with 16 keys, 4 icons for the system status and alphanumeric LCD, allows you to compose and send calls on the Duo digital bus. 3 white LEDs for the camera. Lock actuation time: max 10 sec



**TD2000R** Video door entry panel for the Solvo anti-vandal digital series with RFID predisposition or vigik control systems. It works on digital Duo system. A single element complete with 16 keys, 4 icons for the system status and alphanumeric LCD, allows you to compose and send calls on the Duo digital bus. 3 white LEDs for the camera. Lock actuation time: max 10 sec







**TD2000A** External digital door entry panel of the Solvo series (audio only), for Duo digital system. A single element complete with 16 keys, 4 icons for the system status and alphanumeric LCD, allows you to compose and send calls on the Duo digital bus. Lock actuation time: max 10 sec



**TD2000RA** Audio door entry panel (audio only) of the Solvo anti-vandal digital series with predisposition for RFID module or vigik control systems. It works on digital Duo system. A single element complete with 16 keys, 4 icons for the system status and alphanumeric LCD, allows you to compose and send calls on the Duo digital bus. Lock actuation time: max 10 sec

**Powered from the bus push-button panel with digital keyboard** and display flush-mount (flush-mounting box included) or surface mounting with special accessory. It is available both in audio / video and audio only, with or without predisposition for RFID module. The front plate is made of AISI 304 steel with TORX safety screws. It allows to compose and send calls on the DUO digital bus. Compatible with the Extended Range DUO System to send calls up to 19800 devices, providing the ability to divide the system into 99 blocks. To obtain such performances, each device must be identified by a block address (section of the system to which the device belongs: from 01 to 99) and by a device address (address programmed in the device); block 00 (that is, an unscheduled block) is reserved for compatibility with existing DUO products and schematics.

The panel is powered directly by the DUO line and is equipped with an alphanumeric LCD display with 2 lines for 20 characters and a backlit keyboard with 16 buttons. On the plate there are four light symbols to identify the system status: call , conversation , door open  and busy . A phone book with 800 users is integrated into the device, each of which can be associated with a password for operating the lock and / or an auxiliary relay (for opening doors, gates or other applications). The SOLVO push-button panel manages the "Alias" function, where the "Alias" function means the possibility to assign to each user a numeric call code (from 1 to 5 digits), different from the user address programmed in the video door entry unit; this function is particularly useful in large condominiums where, to ensure a more flexible and intuitive numbering plan, each user can be called with a number whose first digit corresponds to the building, the second two to the floor and the last two to the interior: the user 30521 is the user of building 3, 5th floor, interior 21. The Alias function is particularly useful even when the system is divided into blocks as you can do with the SOLVO push-button panel. It integrates a multi-function relay.

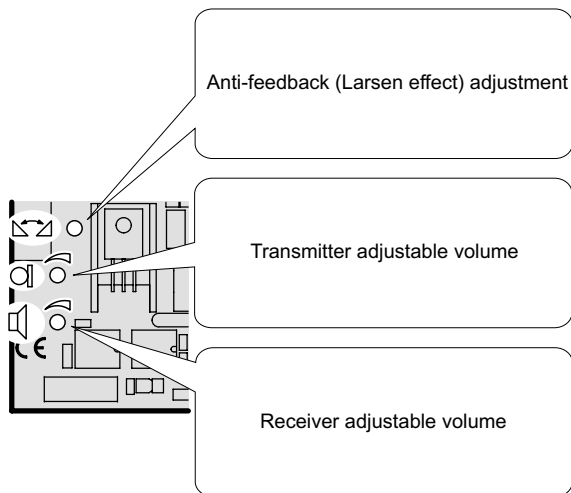
**Technical data**

	<b>TD2000 TD2000R</b>	<b>TD2000A TD2000RA</b>
Powered from DUO line		
Stand by current	60mA	60mA
Operating current	0,40A	0,30A
Door lock activation time	max. 10sec.	
Minimum illumination	0,5 Lux	----
Camera LED	3 (white)	----
Sensor	CMOS 1/3"	----
Number of pixel	440.000	----
Lens	3,7mm	----
Focusing	0,6m ÷ ∞	----
Horizontal / vertical panning	±10°	----

**Terminals**

<b>LP/LP</b>	DUO Bus
<b>PB/PB</b>	Door release push-button
<b>V/M</b>	Input for additional camera (PAL)
<b>S+/S-</b>	Electric door lock
<b>C/NO/NC</b>	Contacts of auxiliary relays

ADJUSTMENTS



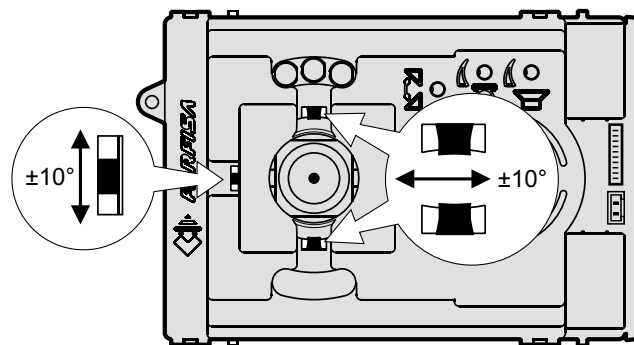
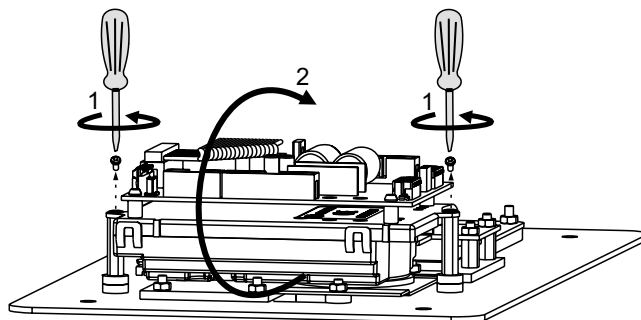
Volumes adjustment

To adjust the volume of microphone and loudspeaker, turn the trimmers and .

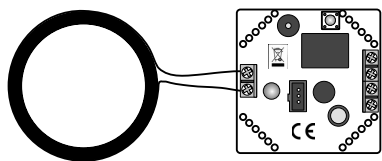
Anti-feedback adjustment (Antilocale)

In case of "feedback" (Larsen effect) in the external unit it is necessary to operate as follow:

- make the call from the door station and lift the handset of the called user;
- remove the microphone from its housing inside the push-button panel, place it on the loudspeaker of the electric door answering system and adjust the trimmer until the feedback stops;
- replace the microphone in its housing.



PROXIMITY READER MODULE



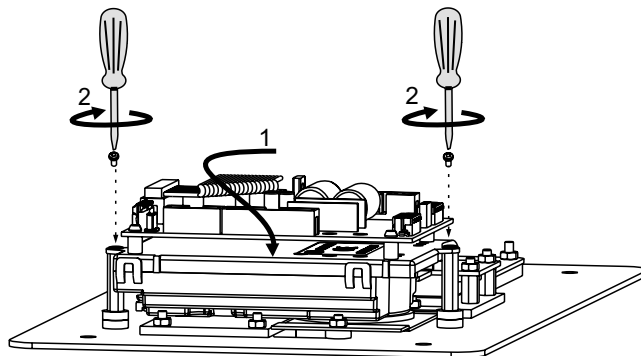
FP2000 (TD2000R-TD2000RA)

Optional proximity reader accessory that can be installed in the TD2000R and TD2000RA.

Technical specification:

- Power supply: 12Vac/dc - 160mA maximum
- Maximum number of user's cards: 400
- Programming: by master card or from PC
- Relay mode: monostable or bistable
- Maximum contacts relay capacity: 24Vac/2 A
- RFID technology: 125KHz (\*)
- Dimensions: 49x49x18mm, fits TD2000R and TD2000RA door stations panels.

(\*) This reader can be used together with FP11/10 and FP12/10.

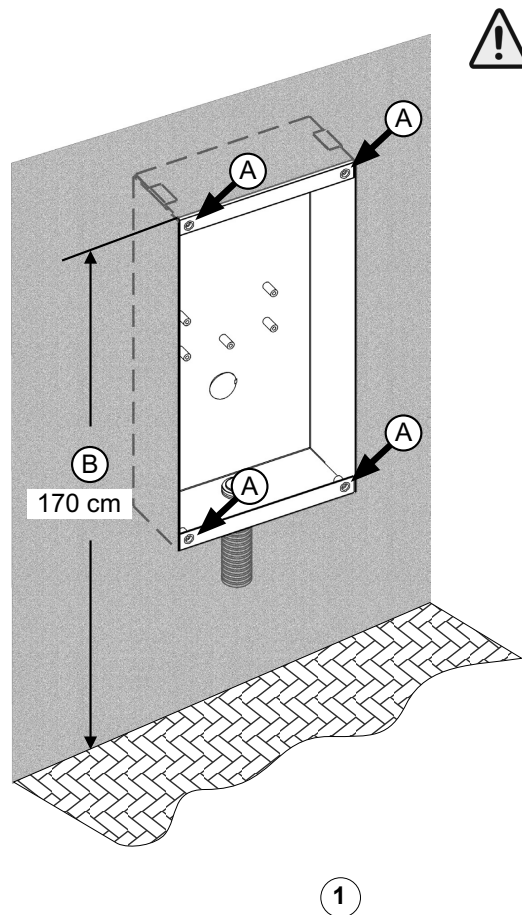


Pan and Tilt (TD2000-TD2000R)

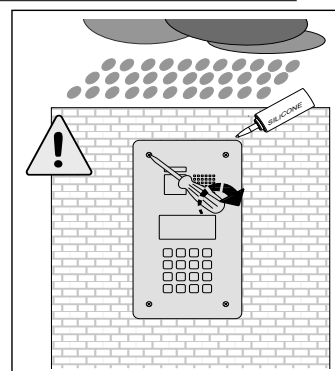
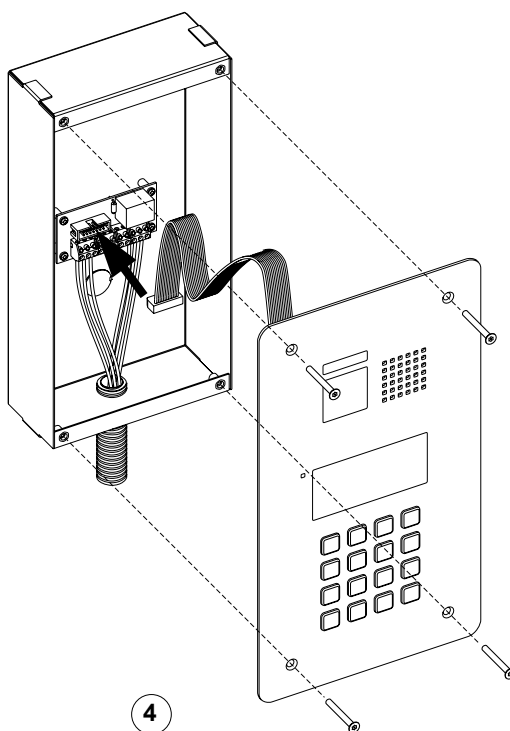
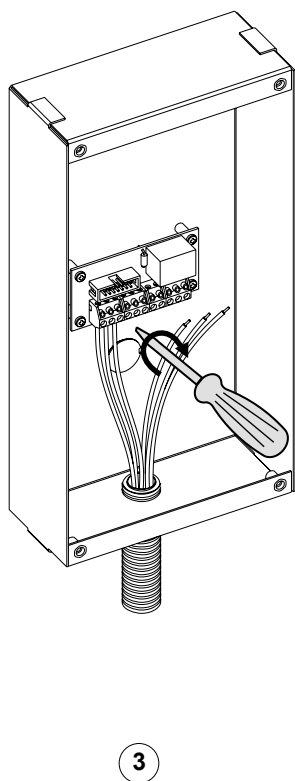
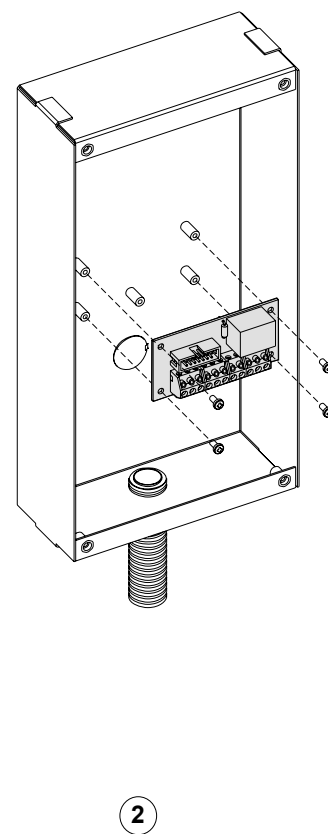
If necessary, the camera frame can be changed manually by moving the levers shown in the figure in the desired direction (horizontal and vertical).



**INSTALLATION**



⚠ A - Before walling-in the back box, protect the push.button panel fixing holes.  
 B - Position the door station unit in such a way that solar rays or other direct lights or intense reflections do not hit the camera lens (TD2000-TD2000R)








**PROGRAMMING**

The most important default settings are reported in the following; to change them or to store new parameters please proceed as indicated in the next paragraphs.


Default settings

- System password = **0039**
- Address of a Door Station = **231**
- Door lock operation time = **1 sec.**
- Auxiliary relays operating time = **1 sec.**

**Enter programming mode**

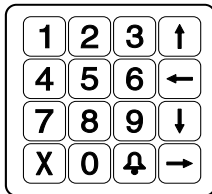
To enter the programming mode dial "00" + , LCD shows "PASSWORD", enter the System Password (default 0039) + , the first line of LCD shows "PROGRAMMING", while the second line shows the first function of the Programming Menu. With arrows  or  it is possible to browse the menu, while  confirms the selection.

**Exit the programming mode**








To exit the programming mode it is necessary to press several times  (it depends from where you are in the menu) until on LCD appears "Enter a number... or select an user...".

How to use the keypad

To program the device use the keypad of the push-button panel







During the programming phase keys, besides the function reported on them, assume also other meanings as described in the following:

-  confirms the selection and forwards you to the next function;
-  cancels the selection and backwards you to the previous function, pressed several times (it depends from where you are in the menu) exits the programming mode. While entering characters moves backward the cursor and cancel the character entered.
-  Browses upward the programming menu. Scrolls the alphabet backward while entering characters;
-  Browses downward the programming menu. Scrolls the alphabet forward while entering characters;
-  Browses rightward the programming menu. Moves the cursor to the right while entering characters;
-  Browses leftward the programming menu. Moves the cursor to the left while entering characters;
-  Switches from upper case to lower case while entering characters.

**PROGRAMMING MENU**

In programming mode, the first line of LCD shows the name of the programming we are going to execute, while the second line shows the functions that can be programmed; entering the programming mode, functions that can be selected are:





- **Language**
- **Directory**
- **System**
- **Miscellaneous**
- **Default**

With  or  arrows it is possible to scroll the functions, while  key confirms the selection.  key backwards you and exits the programming mode.

**Language**

Available languages are:


- **Italian**
- **English**
- **French**
- **Spanish**
- **German**
- **Polish**
- **Slovenian**



Select language with  or  arrows and press  to confirm.  key backwards you to the previous menu.

**Directory**

Alphabetical list of users; directory has two different formats:





- during normal operations of the system (in the list are reported only users who have the flat address);
- in programming phase (in the list are reported all the users including those who have a password, but not the flat address);

 **Attention:** users must always have a name and at least one of the two following fields: flat address or password.



 key forwards you to programming;  key backwards you to the previous menu.




In the directory menu the following functions are available:

- **New user**
- **Modify a user**
- **Delete a utente**
- **Delete all users**
- **Recovery users**
- **Download**
- **Upload**
- **Format memory**

With  or  arrows it is possible to scroll the functions, while  key confirms the selection.  key backwards you and exits the programming mode.


**New User**


Each new user (max 800) must be stored in the directory.  key forwards you to programming (if 800 users are already stored, the system doesn't allow you to enter the menu "New User");  key backwards you to the previous menu. The following parameters must be programmed for each user:

- Enter Name  
Name of the user, 20 characters are available that can be either letters or numbers; to enter the name refer to "How to use the keypad", then press  to move to the next programming.  Attention: the name of the user must be always programmed.
- Enter Address  
In "a wide range" DUO system, the user address is composed of two parts:
  - Block address: block of the system to which the user belongs, from 01 to 99; enter the block address and then press  to move to the next programming; block 00 is reserved for the compatibility with the traditional DUO devices.
  - Flat address: in each block of the system, the users must be identified by an univocal address from 001 to 200; enter the

flat address and then press  to move to the next programming.

- Enter Alias


An "Alias" can be linked to each user, that is a number, from 1 to 5 digit, with which the user can be called independently from the flat address of his device; enter the alias and then press  to move to the next programming.


 **Attention:** whether the alias has been programmed or not, user can be always called by dialing his flat address.




- Enter Password




For each user only one password, of 1 to 8 digit, can be stored; if a user requires more than one password, it is necessary to store more users with the same name, but progressively numbered, which have different passwords and only the first of them has also the address. For example user Mr. Brown has address and password, user Mr. Brown1 has only the password and so on with Mr. Brown2, etc.




For special users, such as postman, maintenance personnel, cleaning staff, etc., users with only name and password, but without address, must be created.


 **Attention:** in the system can't be stored two users who have the same password.

Enter the password and press  to move into next phase where one or more operating functions must be linked to the password. Operating functions which can be linked are:



- Activate S+S-: releases the door lock connected to the terminals S+ and S-; with the arrows  or  select <YES> or <NO> and then press  to confirm and move to the next programming.

- Activate Auxiliary Relay: enables the auxiliary relays (contacts C, NC and NO are available on the terminal board); with the arrows  or  select <YES> or <NO> and then press  to confirm and move to the next programming.


- Activate Ring-me: enabling this function, as soon as a password is recognized, a single ring is sent to the user linked to that password. This function is normally enabled together with one or both the functions previously described, and it is useful to inform you that someone has successfully used the password linked to your name; with the arrows  or  select <YES> or <NO> and then press  to confirm and move to the next programming, LCD shows briefly "saved" and the system returns to "Programming the directory".


 **Attention:** when programming a new user, always must be entered his name and at least one of the two following parameters: address of the flat or password. Password must be unique consequently can't exist a duplicated passwords.


**Modify a User**


In this section it is possible to modify the parameters previously stored for a user.  key forwards you in "modify a User" (if there aren't users stored in the directory, the system doesn't allow you to access this menu);  key backwards you to the previous menu.




To simplify the search of a user, user's directory can be sorted by:



- Sort by Name; all the users are listed by their name. Before the name, between <>, is reported a number representing the order with which the user has been stored. Press  to get the directory sorted by name.




- Sort by Alias; all the users are listed by their alias. Before the alias, between <>, is reported a number representing the order with which the user has been stored; users without alias are listed for the last as "----", but following their storing order (reported between <>). Press  to get the directory sorted by alias.




- Sort by Password; all the users are listed by their password. Before the password, between <>, is reported a number representing the order with which the user has been stored; users without password are listed for the last as "----", but following their storing order (reported between <>). Press  to get the directory sorted by password.




- Sort by Address; all the users are listed by their address. Before the address, between symbols <>, is reported a number representing the order with which the user has been stored; users without password are listed for the last as "----", but following their storing order (reported between <>). Press  to get the directory sorted by name.



After sorting the directory in your preferred way, with  or  arrows it is possible to scroll the users, with  key confirm the selection. The first line of LCD shows:


- Modify name; on the second line of LCD, the user to be modified is displayed; to modify the name see "How to use the keypad", then press  to confirm and move to the next parameter. If the name of the user should not be modified press directly  to move to the next parameter.


- Modify block address; on the second line of LCD, the block address of the user to be modified is displayed (if the user hasn't the block address, no number is displayed); press  key to erase the previous block address, if any, and then enter the new address. Press  key to confirm and to move to the next parameter. If the block address of the user should not be modified press directly  to move to the next parameter.




- Modify flat address; on the second line of LCD, the flat address of the user to be modified is displayed (if the user hasn't the flat address, no number is displayed); press  to erase the previous flat address, if any, and then enter the new address. Press  to confirm and to move to the next parameter. If the flat address of the user should not be modified press directly  to move to the next parameter.




- Modify alias; on the second line of LCD, alias to be modified is displayed (if the user hasn't an alias, no number is displayed); press  to erase the existing alias, if any, and then enter the new alias, press  key to confirm and to move to the next parameter. If the alias should not be modified press directly  key to move to the next parameter.




- Modify password; on the second line of LCD, the password linked to the user is displayed (if the user hasn't a linked password, no number is displayed); press  to erase the previous password, if any, and then enter the new password. Press  key to confirm and to move to the next parameter.





 **Attention:** system doesn't allow to have two users with the same password.

If the password of the user shouldn't be modified press directly  to move to the next parameter.



- Activate S+S-: release the door lock connected to terminals S+ and S-; with the arrows  or  select <YES> or <NO> and then press  to confirm and move to the next programming.

- Activate Relay: activate the auxiliary relays; with the arrows  or  select <YES> or <NO> and then press  to confirm and move to the next programming.

- Activate Ring-me: send a single ring to the user to which the password is linked; with the arrows  or  select <YES> or <NO> and then press  to confirm.




All the parameters of the user have been modified, LCD displays for a while "saved" and then again the name of the modified user. With  or  arrows select another user or press  to return to the previous menu; press  several times, to exit the programming.





**Delete a User**

It is possible to delete a user from the directory. Pressing  you access the menu "delete a user" (if there aren't users stored in the directory, the system doesn't allow you to access this menu);  key backwards you to the previous menu.



To simplify searching of the user to be deleted, user's list can be sorted for:

- Sort by Name; see paragraph "Modify a user".
- Sort by Alias; see paragraph "Modify a user".
- Sort by Password; see paragraph "Modify a user".
- Sort by Address; see paragraph "Modify a user".





After sorting the directory in your preferred way, with  or  arrows it is possible to scroll the users, while  key confirm the selection. The first line of LCD shows:


- Delete <n°> "user name"? With arrows  or  select <YES> or <NO> and then press ; choosing <NO> you will return to the selection of the user to be deleted, choosing <YES> LCD will briefly show "saved" to indicate that the operation has been done and the system moves back to the list of the users to be deleted. Press  to return to the previous menu.

**Delete all**



It is possible to delete, with a single operation, all the users from the directory; the command doesn't affect the other settings of the system. Pressing  key you access the menu "Delete all" (if no user is stored in the directory, the system doesn't allow you to access this menu), whilst pressing  you will return to the previous menu.

Accessing the menu "Delete all", the first line of LCD shows:





- Delete all? With arrows  or  select <YES> or <NO> and then press ; choosing <NO> you will return to the menu "Delete all", choosing <YES> all the users will be erased, the directory will be blanked and then the system returns to the menu "Delete all". Press  key to return to the previous menu.


 **Warning:** this operation will erase all the users from the directory. In case of unwanted action it is possible to recovery erased data, if meanwhile no new users have been stored, with the function "Recovery all" described in the next paragraph.

**Recovery all**


It is possible to recovery all the users just erased from the directory; pressing  key you access the menu "Recovery all", whilst pressing  key you will return to the previous menu.

Accessing the menu "Recovery all", the first line of LCD shows:


- Recovery all? With arrows  or  select <YES> or <NO> and then press ; choosing <NO> you will return to the menu "Recovery all", choosing <YES> all the users, just erased from the directory, will be recovered, directory will be restored and then the system returns to the menu "Recovery all". Press  to return to the previous menu.

 **Warning:** this function can be executed at any time, but it is necessary to pay attention that, if some new users have been stored, from the time the directory has been erased and when the function "recovery all" is executed, old data will not be recovered completely.

**Download**


By pressing  key the first line of LCD will show: "Download" and the device is ready to receive a configuration file from the USB port. For details see paragraph "USB Connection".



**Upload**





By pressing  key the first line of LCD will show: "Upload" and the device is ready to send a configuration file to the USB port. For details see paragraph "USB Connection".

**Format memory**



By launching this function the device memory will be completely blanked.

 **Warning:** device memory will be completely blanked and, after this operation, no data will be recoverable. Before launching "Format memory" evaluate carefully if really this is the action you need.




Pressing  key you access the menu "Format memory" whilst with  key you return to the previous menu. Accessing the function "Format memory" the first line of LCD will shows:

Format memory? With arrows  or  select <YES> or <NO> and then press ; choosing <NO> you will return to the menu "Format memory", choosing <YES> a memory blanking procedure will start, at the end the system returns to the menu "Format memory". Press  to return to the previous menu.



**System**

In this section, system parameters can be programmed, pressing the  key you access the parameter to be programmed, while pressing the  key you return to the previous menu. Parameters that can be programmed are:





- **Addresses**
- **Timings**
- **Administrator Password**

With  or  arrows you can select the parameter to be set, while the  key backwards you to the previous menu.





**Addresses**

Addresses of the devices driven by the external door station, except the addresses of the users which must be programmed in the proper section of the menu. Pressing  you enter the menu "Programming of addresses", while pressing  you return to the previous menu. Addresses to be set are:





- **Door station address**
- **Digital exchanger address (PDX)**
- **Address of PB key, (PB-PB)**
- **Address of the auxiliary relay**
- **Video OFF -1- Start**
- **Video OFF -1- End**
- **Video OFF -2- Start**
- **Video OFF -2- End**
- **AUX TLC 1÷8**
- **Main AUX TLC**

With  or  arrows select the requested parameter and confirm with the  key.  key will backwards you to the previous menu.







**Door station address**

By pressing  you enter the programming of the door station address, whilst with  key you return to the previous menu. Entering the menu, the first line of LCD shows "Enter address", whilst at the end of the second line the currently stored value is reported (231 from factory). With  erase the old number, and with the keypad, enter the new one (from 231 to 240), then confirm by pressing , system returns to the previous menu.

**Digital exchanger address (PDX)**

By pressing  you enter the programming of the digital exchanger address, whilst with  key you return to the previous menu. Entering the menu, the first line of LCD shows "Enter address", whilst at the end of the second line the currently stored value is reported (no address from factory). With  key erase the old address, if present, and, with the keypad, enter 201, if the door station has to call a main digital exchanger, or 210, if it has to call a secondary digital exchanger, then confirm by pressing , system returns to the previous menu.

**Address of PB key (PB-PB)**

Push-button PB (terminals PB-PB) can be used to call directly a user of the system, instead of operate as "door lock release". In this case it is necessary to program the address of the user to be called. By pressing  you enter the programming, whilst with  key you return to the previous menu. LCD shows "Enter block address" and on the bottom of the second line, the address currently stored is reported (no address from factory). With  key erase the old address, if present, and enter the new one, then confirm by pressing , display will show "Enter flat address" and on the bottom of the second line, the currently stored value is reported (no address from factory). With  key erase the old flat address, if present, and enter the new one, then confirm by pressing , system returns to the previous menu.

**⚠ Attention:** if button PB-PB is programmed to send a call, it can't be used to release the door lock. Any number stored in this parameter sets the PB-PB button to send a call, consequently, if you wish to use PB-PB button to release the door lock, do not program any value in it.

**Address of the auxiliary relay**

An actuator address (211-230) or a user address (001-200) can be linked to the auxiliary relay. Depending on the linked address, the auxiliary relay operates in a different ways.

- Actuator address. Storing an actuator address, that is a block address between 00 e 99 and a device address between 211 e 230, the auxiliary relay operates as an actuator and, when called, it moves its contacts (C-NC-NO) according to the operating mode set in "System" → "timings" → "relay".
- User address. Storing a user address, that is a block address between 00 e 99 and a device address between 001 e 200, the auxiliary relays operates its contacts (C-NC-NO) only when a "lock release" command arrives from a user with address equal or higher to that stored in the device; if address 00-000 is stored, the auxiliary relay will be activated by the "door release" command sent by any user. Operating mode of its contacts is set in "System" → "timings" → "relay".

To program the address select "Relay address" and press **⏏**. LCD shows "Enter block address", while on the bottom of the second line the address currently stored is reported (no address from factory). With the **X** key erase the old address, if present, and enter the new one, then confirm by pressing **⏏**, display will show "Enter flat address" whilst, on the bottom of the second line, the currently stored value is reported (no address from factory). With the **X** key erase the old flat address, if present, and enter the new one, then confirm by pressing the **⏏** key, system returns to the previous menu.

**⚠ Attention:** to identify the users with address equal or higher to that stored, both block and flat address must be considered (for example user 03-123, has an higher address with respect to the user 02-200).

Storing 00-000, all the users of the system, by pressing the "open door" button, will activate the auxiliary relay instead of operating the door release circuit.

**Video OFF -1- Start (TD2000-TD2000R)**

In this parameter has to be stored the starting (lower) address of the first group of users which do not have to receive the video signal (for example users with only audio intercom).

By pressing the **⏏** key you enter the programming mode. LCD shows "Enter block address", while on the bottom of the second line the address currently stored is reported (no address from factory). With the **X** key erase the old address, if present, and enter the new one, then confirm by pressing the **⏏** key, display will show "Enter flat address" whilst, on the bottom of the second line, the currently stored value is reported (no address from factory). With the **X** key erase the old flat address, if present, and enter the new one, then confirm by pressing **⏏**, system returns to the previous menu.

**Video OFF -1- End (TD2000-TD2000R)**

In this parameter has to be stored the ending (higher) address of the first group of users which do not have to receive the video signal (for example users with only audio intercom).

By pressing the **⏏** key you enter the programming mode. LCD shows "Enter block address", while on the bottom of the second line the address currently stored is reported (no address from factory). With the **X** key erase the old address, if present, and enter the new one, then confirm by pressing the **⏏** key, display will show "Enter flat address" whilst, on the

bottom of the second line, the currently stored value is reported (no address from factory). With the **X** key erase the old flat address, if present, and enter the new one, then confirm by pressing the **⏏** system returns to the previous menu.

**Video OFF -2- Start (TD2000-TD2000R)**

In this parameter has to be stored the starting (lower) address of the second group of users which do not have to receive the video signal (for example users with only audio intercom).

By pressing the **⏏** key you enter the programming mode. LCD shows "Enter block address", while on the bottom of the second line the address currently stored is reported (no address from factory). With the **X** key erase the old address, if present, and enter the new one, then confirm by pressing **⏏**, display will show "Enter flat address" whilst, on the bottom of the second line, the currently stored value is reported (no address from factory). With the **X** key erase the old flat address, if present, and enter the new one, then confirm by pressing **⏏** system returns to the previous menu.

**Video OFF -2- End (TD2000-TD2000R)**

In this parameter has to be stored the ending (higher) address of the second group of users which do not have to receive the video signal (for example users with only audio intercom).

By pressing the **⏏** key you enter the programming mode. LCD shows "Enter block address", while on the bottom of the second line the address currently stored is reported (no address from factory). With the **X** key erase the old address, if present, and enter the new one, then confirm by pressing **⏏**, display will show "Enter flat address" whilst, on the bottom of the second line, the currently stored value is reported (no address from factory). With the **X** key erase the old flat address, if present, and enter the new one, then confirm by pressing **⏏** system returns to the previous menu.

**AUX TLC 1÷8**

Push-button panels TD2000 can drive external video modulators (type VM2521) to which up to eight additional cameras can be connected. In the case of additional cameras, the addresses of the additional cameras present in the installation and, if necessary, the address of the main video camera (Main AUX TLC) must be programmed.

To program the address of the first additional camera select from the menu "AUX TLC1" and press button **⏏** to confirm, display will show "Enter address" and on the bottom of the second line, the currently stored value is reported (no address from factory). With **X** key erase the old address, if present, and enter the new one, then confirm by pressing **⏏**, system returns to the previous menu.

If required, proceed in the same way programming the addresses of the other additional cameras from AUX TLC 2 to AUX TLC 8 otherwise continue with other programmings.

**Main AUX TLC**

The main camera is the camera from which the audio-video module starts the cyclic scan of the additional cameras.

To program the address of the first main camera select from the menu "Main AUX TLC" and press button **⏏** to confirm, display will show "Enter address" and on the bottom of the second line, the currently stored value is reported (no address from factory). With **X** key erase the old address, if present, and enter the new one, then confirm by pressing **⏏**, system returns to the previous menu.

**Timings**

In this section it is possible to program the timings of all the actuations of the system. By pressing **⏏** you enter the programming procedure, whilst pressing **X** key you return to the previous menu. Parameters that can be programmed are:

- Activation time for S+S-: activation time for the "open door" circuit (terminals S+ ed S-).
- Activation time for auxiliary relè: activation time for the auxiliary relay (terminals C, NC ed NO).

With arrows **↑** or **↓** select the parameter to be programmed and confirm with the **⏏** key. **X** key backwards you to the previous menu.

**Activation time for S+S-**

By pressing you enter the programming mode, while key backwards you to the previous menu. Entering the menu, the first line of LCD shows "Enter time", while on the bottom of the second line the activation time currently stored is reported (1 sec. from factory). With erase the old value and then, enter the new one (max. 9 sec.) and then confirm by pressing , display will show briefly "saved" after that the system returns to the previous menu.

**Attivation time for the auxiliary relay**

By pressing you enter the programming mode, while key backwards you to the previous menu. Entering the menu, the first line of LCD shows "Enter time", while on the bottom of the second line the activation time currently stored is reported (1 sec. from factory). With key erase the old value and then, enter the new one (max. 98 sec.; entering the value 99 the auxiliary relay will act as bi-stable device) and then confirm by pressing , display will briefly show "saved" after which the system returns to the previous menu.

**Administrator Password**

From the factory the administrator password is 0039, but it can be changed with a new one chosen by the installer or the installation manager. Pressing you enter the programming mode and at the end of the second line of the LCD the current administrator password is reported (0039 from factory), erase the old one using the key and then enter the new password, press to confirm, display will briefly show "saved" after which the system returns to the previous menu.

**Attention:** write down and keep the administrator password in a safety place, without the administrator password it is impossibile to program the device.

**Miscellaneous**

In this section of the menu it is possible to program the general parameters of the system which are:

- key to send a call
- Conversation time
- External camera (TLC)
- Welcome message
- LCD contrast
- FW version

With or arrows select the parameter to be set and confirm with . key backwards you to the previous menu.

key to send a call

It is possible to chose the operating mode for sending a call which can be:

- manual: after dialing the user address, its alias or after selecting the user name from the directory, it is necessary to press to send the call;
- automatic: call is automatically sent 3 sec. from when you have dialed the user address, its alias or you have selected the user name from the directory, therefore it is not necessary to press to send a call.

By pressing the key you enter the programming mode " key to send a call" and the first line of LCD shows:

- key to send call? With arrows or select <YES> or <NO> and then press ; the system stores your selection and returns to the previous menu.

**Conversation time**

This function extends the conversation time from 90 sec. (factory value) to 4 min. Pressing you enter the programming mode "Conversation time 4 min.", while key backwards you to the previous menu. Entering the programming mode, the first line of LCD shows:

- Conv. time 4 min? With arrows or select <YES> or <NO> and then press to confirm. Choosing <YES> conversation time will be extended up to 4 min; it is always possible to close the conversation at any time by pressing on the door station or hanging-up the handset on the videointercom. Choosing <NO> the conversation time remains set to 90 sec., but it is always possible to double the conversation time pressing, on the door station keypad, the key when a tone will warn you that the conversation time is going to expire.

**External camera**

Enabling this function the door station will manage an external additional camera besides the one present on the device. When a video door phone sends the "monitoring" commands, the door station switches from the two cameras and on the video door phone you get alternatively the two related images. By pressing you enter the programming mode "External camera" and the first line of LCD shows:

- External TLC? With arrows or select <YES> or <NO> and then press to confirm; the system stores your selection and returns to the previous menu.

**Welcome message**

During standard operations, on the LCD of the door station a welcome message, reporting short info on how to call a user, is displayed. It is composed of two pages (2 lines for 20 characters each) that can be customized and which would alternate each 6 seconds. Pressing you enter the programming mode "Message programming", whilst key backwards you to the previous menu. The programming section is composed of two parts:

- Message 1
- Message 2

With arrows or select which of the two messages you wish to modify, then press to confirm. LCD shows a blanked display on which it is possible to write a message using the keypad of the door station as described in the paragraph "How to use the keypad". After entering the new message, press to store. Proceed in the same way, if required, to enter the second message.

**Attention:** it is sufficient to program only one of the two messages so that the system considers it as a welcome message, in this case the LCD will remain fix on it.

**LCD Contrast**

It is possible to adjust the LCD contrast; pressing you enter the "LCD contrast" menu and the first line of LCD shows:

- LCD contrast: with or arrows, increase or decrease the contrast value, as indicated on the display, and press to confirm, system stores the entered value and returns to the previous menu.

**Firmware version**

Pressing LCD will show the firmware version currently programmed in the device. Pressing the the system returns to the previous menu.

**Default**

Selecting this command all the system parameters will be restored to their factory values with the exception of the user directory which remains programmed at it is.

**Attention:** administrator password will be restored to its factory value (0039).

Pressing you enter the "Default" mode and the first line of LCD shows:


- Default? With arrows or select <YES> or <NO> and then press to confirm, system restores all the parameters to the factory values and then returns to the previous menu.

**USB CONNECTION**


TD2000 has an USB port that can be used to download or upload a file from/to a PC with the users to be stored in the repertory. To download or upload a file it is necessary to have installed on the PC the program "Contact Manager", last version can be downloaded from the download area of the web site of ACI FARFISA (www.farfisa.com). To exchange data it is necessary to operate as in the following:

1. On your PC install and run the program "Contact Manager".
2. Connect, as a first, USB cable to the USB port of TD2000;
3. Connect the other side of the USB cable to your PC; TD2000 will be powered by the USB port and the red LED starts blinking quickly. **⚠ Attention:** for powering reasons display of push-button panel TD2000 powers ON without backlighting.
4. On the TD2000 access the programming menu and under the voice "Directory" select "Download" or "Upload" according to the required function.

**"Download"**





- 5a. On the TD2000 access the menu and select "Download" under the voice "Directory", then press key , the display will show "Download". Push-button is waiting to download from your PC a file containing the users and the data to be stored in the repertory .
- 6a. In the Contact Manager program, import the file you intend to send to the TD2000, and select the voice "Download to USB device".
- 7a. Data transfer starts, the display of TD2000 will show in sequence the transferred data.



**"Upload"**




- 5b. On the TD2000 access the menu and select "Upload" under the voice "Directory", then press , display will show "Upload". Push-button is waiting to send to your PC a file containing the users and data already stored in its repertory.
- 6b. In the "Contact Manager" program, select the voice "Upload from USB device".
- 7b. Data transfer starts and at the end, the display of TD2000 and the monitor of your PC will show the number of transferred bytes.
8. Disconnect, as a first, USB cable from your PC and then from TD2000.



**OPERATION**



Check first that connections of the system have been done correctly. Power ON the system, display will show for 3 seconds the writing "TD2000 - TD2000R" followed by the code of SW release and then "Dial the address..." alternately with "Select user...".



To make a call dial the code (address or alias) of the desired user, in case of a mistake press  to erase, or press  to confirm (call is automatically sent after 3 seconds, therefore without pressing button , if <NO> has been selected in the programming function " key to send a call"). Call can be sent also selecting the name of the user from the building directory, see "How to use the building directory". Not confirmed numbers or names are automatically erased after 25 seconds.

If the intercom line is free and the called number exists, a confirmation tone will be emitted and the display shows writing "Call/---", at the same time icon  lights up, otherwise a busy tone will be emitted, the display shows the writing "Busy" and icon  lights up.








By pressing key , running call will be stopped, icon  turns OFF and the system is ready again for a new call. Called user, picking up the handset, enables communication with the door station for 90 seconds (that time can be extended as described in "Conversation time"). The display of the push-button panel shows "talk with ---) and the icon  lights up.

10 seconds before communication time expires, push-button panel emits a reminding tone and its display and icon  starts blinking; to continue the conversation for other 90 seconds, press key .


To operate the door lock release from the videointercom, press button ; operating time for door lock release is 1 second (up to 10 seconds, if differently programmed), on the push-button panel, for all the door lock release operating time, icon  will lights up.

Hanging up the handset on the videointercom or pressing the  key on the push-button panel, the system comes back to the stand-by operating mode and icon  turns OFF.






**How to use the building directory**

Directory stores, in alphabetical order, all the users of the building and it is possible to scroll them with  e  arrows. To send a call, after selecting the name, press the  key (call is automatically sent after 3 seconds, therefore without pressing button , if <NO> has been selected in the programming function " key to send a call"). To make easier to find a users, with  e  arrows, it is possible to chose the letter (uppercase or lowercase) with which starting to display the directory.

**Releasing the door lock or actuating additional commands, by entering a password**

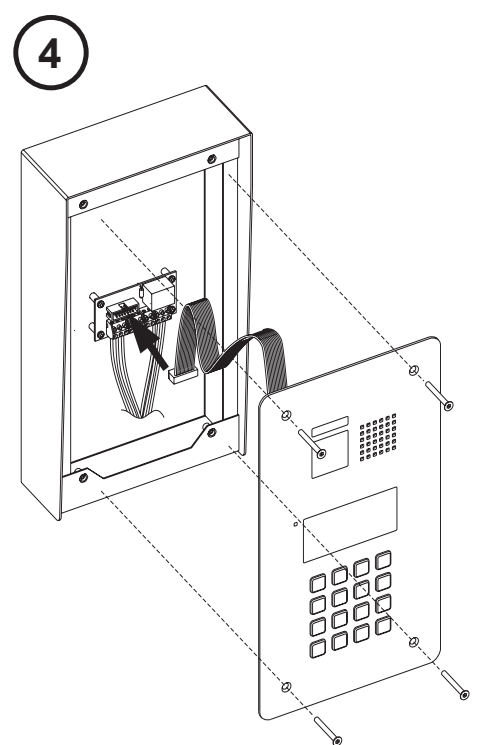
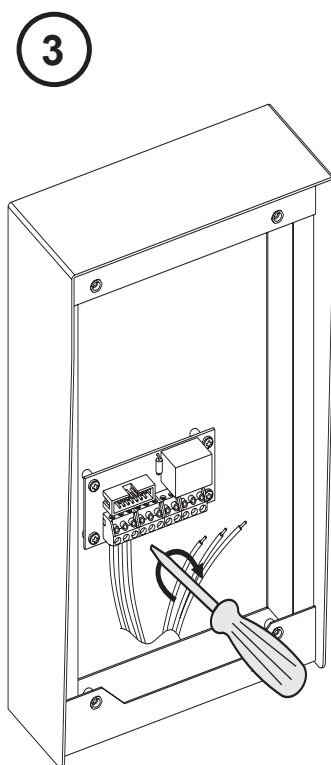
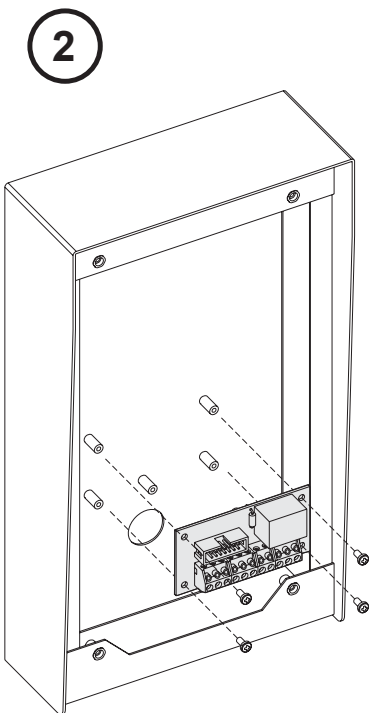
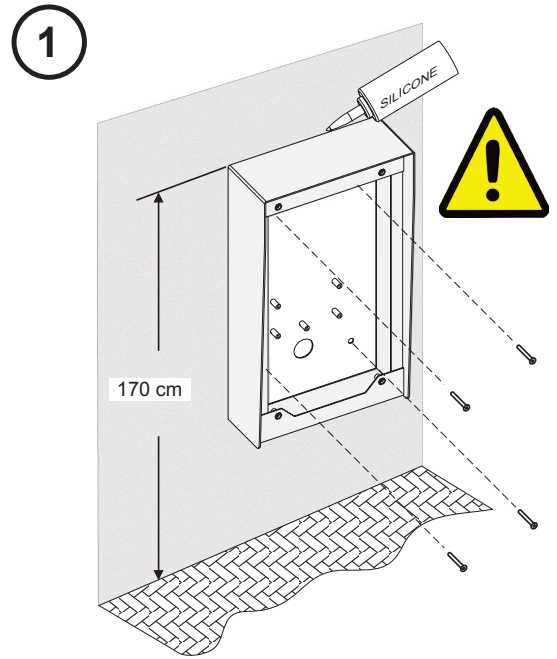
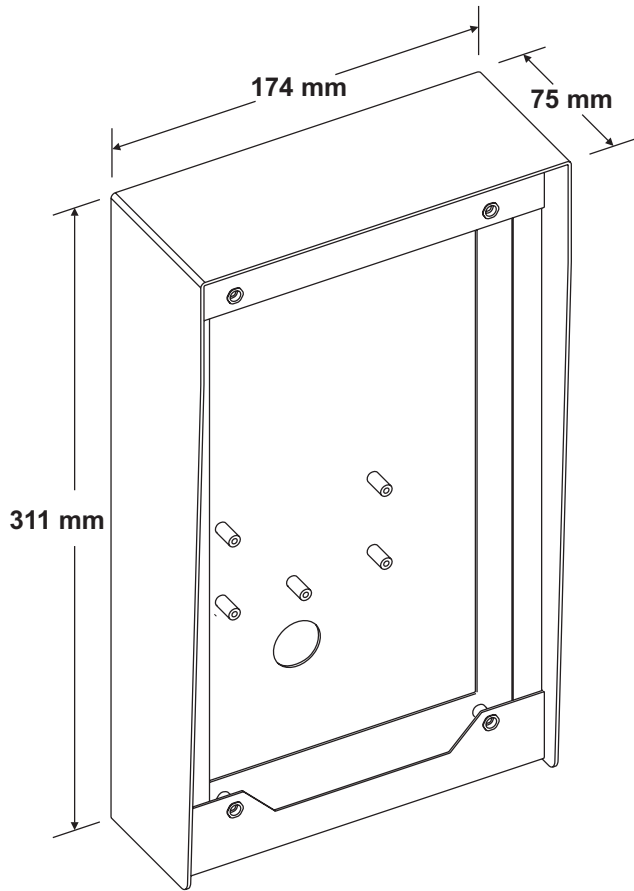
From push-button panel, even if the system is in "busy" operating mode (icon  ON), it is possible, by entering one of the passwords previously stored (max 800), to unlock the door, or actuating additional commands (depending on the commands linked to the "Password" when storing a "New user"),

To operate it is necessary:

- dial 00;
- press  (the entered code 00 is automatically acquired after 3 seconds, therefore without pressing button , if <NO> has been selected in the programming function " key to send a call");
- display shows "Password";
- enter, within 10 seconds, the password; each entered digit is displayed as an asterisk;
- press , if the entered password is correct, the push-button panel emits a confirmation tone and door lock, or the other commands associated to the password, are activated (in the case of lock release, for all the activation time, the icon  lights up), when the operation ends push-button panel comes back to the current operating mode of the system (free or busy).

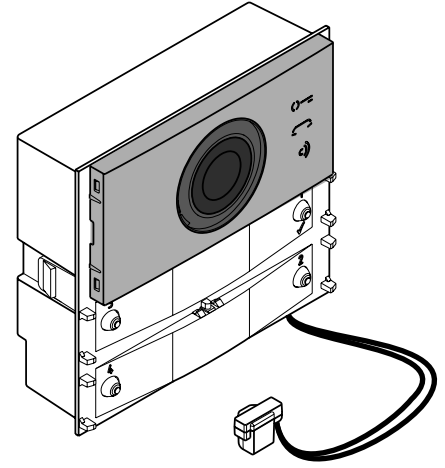
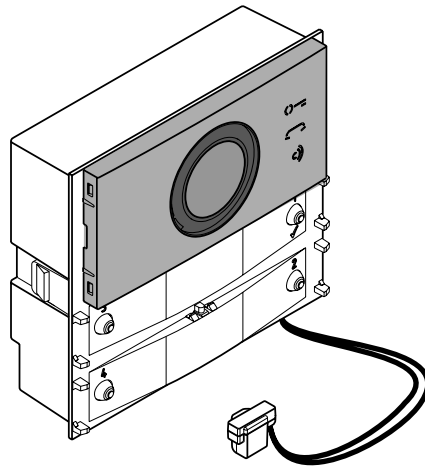
RAIN SHELTER 290S/0

290S/0 Rain shelter





The front plate is in anodized aluminum with a brushed finish, a color camera with a 2.3 mm focal length and an extremely wide-angle lens, a built-in camera speaker and a microphone in the lower part that is not visible, particularly protected and therefore weatherproof. 3 LEDs light up the icons to indicate the operating status: call sending, busy, active conversation, lock opening. The series also includes supports for the visually impaired. With flush or surface mounting, Alba is also suitable for renovations due to the installation compatibility in Farfisa MODY series boxes. Alba has 2 independent outputs for activating locks and other loads. The assembly of the modules in the frame is simplified thanks to the quick interlocking coupling and the push-button panel is able to self-configure itself. It is compatible with the Duo Extended Range.



**CA2124AB. ALBA series Audio unit for DUO digital system**

Audio (CA2124AB) module for ALBA push-button panels can be used in DUO FARFISA systems.

The module is equipped with:

- automatic configuration of call buttons;
- 200 calls can be handled in traditional configuration and up to 19800 calls in Extended Range DUO configuration;
- SW supports external video modulators (PDX1);
- electric lock connected directly to terminals S+ and S-. Local lock open button connected to PB and GN terminals;
- PB terminal configurable as input for open door sensor;
- 2 Single-Button or 4 Double-Buttons configuration;
- complete module programming via the 4 call buttons;
- 3 back-illuminated frontal symbols to indicate system status (busy-call-answer-lock open);
- auxiliary relay (contacts C and NA);
- connector for connection to the subsequent modules.

**Technical data**

Power supply: from the DUO line  
 Consumption stand-by: 0.02A  
 in operation: 0.2A  
 Max current delivered to other mod. 0.1A  
 Lock activation current  
 releasing: > 1A (10msec.)  
 holding: 180mA  
 Operating temperature: -25 ÷ 50°C  
 Maximum permissible humidity: 90% RH

**Terminals and Connectors**

- LP/LP** DUO line
- S+/S-** Electric lock
- PB/GN** Lock opening button
- J3** Programming connector
- J4** Connector connecting other mod.
- J13** Auxiliary relay contacts (30Vdc-1A)

**CV2124AB. ALBA series Audio-Video unit for DUO digital system**

Audio-Video (CV2124AB) module for ALBA pushbutton panels can be used in DUO FARFISA systems.

The module is equipped with:

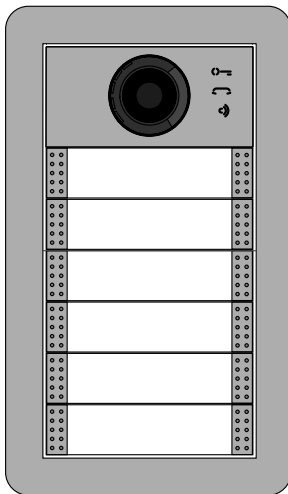
- video camera with white LED lighting;
- automatic configuration of call buttons;
- 200 calls can be handled in traditional configuration and up to 19800 calls in Extended Range DUO configuration;
- SW supports external video modulators (PDX1);
- electric lock connected directly to terminals S+ and S-. Local lock open button connected to PB and GN terminals;
- PB terminal configurable as input for open door sensor;
- 2 Single-Button or 4 Double-Buttons configuration;
- complete module programming via the 4 call buttons;
- 3 back-illuminated frontal symbols to indicate system status (busy-call-answer-lock open);
- auxiliary relay (contacts C and NA);
- connector for connection to the subsequent modules.

**Technical data**

Power supply: from the DUO line  
 Consumption stand-by: 0.02A  
 in operation: 0.2A  
 Max current delivered to other mod. 0.1A  
 Lock activation current  
 releasing: > 1A (10msec.)  
 holding: 180mA  
 Operating temperature: -25 ÷ 50°C  
 Maximum permissible humidity: 90% RH

**Terminals and Connectors**

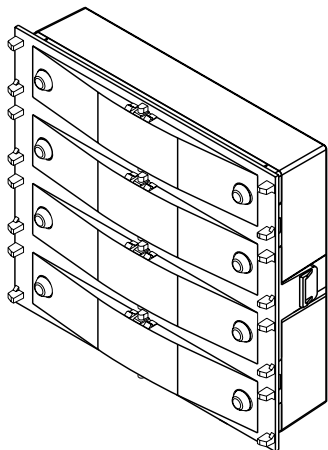
- LP/LP** DUO line
- S+/S-** Electric lock
- PB/GN** Lock opening button
- J3** Programming connector
- J4** Connector connecting other mod.
- J13** Auxiliary relay contacts (30Vdc-1A)



3  
A

DUO system

ALBA



**CT2138AB, ALBA series Push-Button Module for DUO digital system**

The CT2138AB module allows you to add up to 4 buttons (4 or 8 calls) to the composition of the panel. Connects to the previous module using the supplied cable

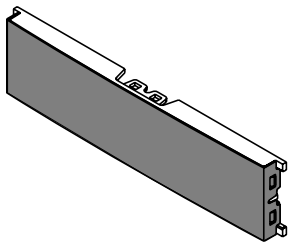
**Technical data**

Power supply: from the DUO line  
Power Consumption: 0.01A

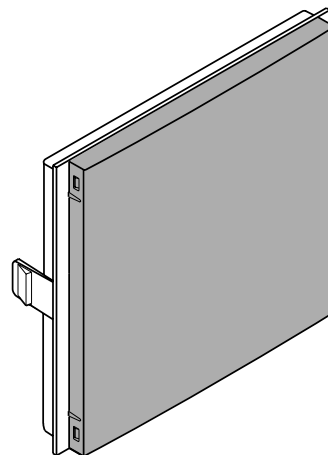
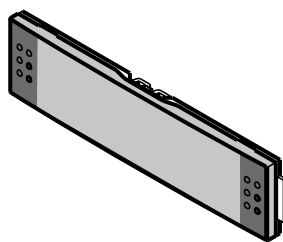


Up to a maximum of 8 CT2138AB can be connected to each CV2124AB or CA2124AB

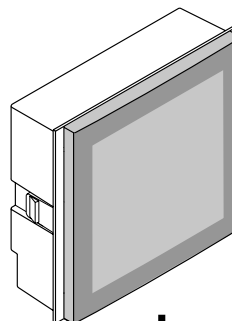
**AB20. Cover for button.**



**AB21. Button module.**  
On surface raised braille sign for easy recognition for blind users.

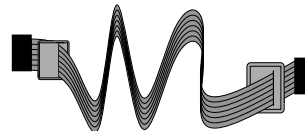


**AB00. Blank module ALBA.**



+

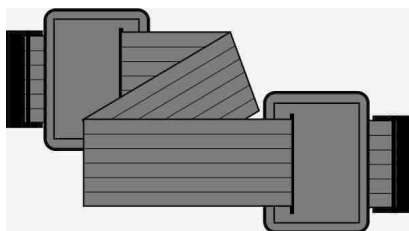
**2 x**



**AB50. ALBA series Number Module.**

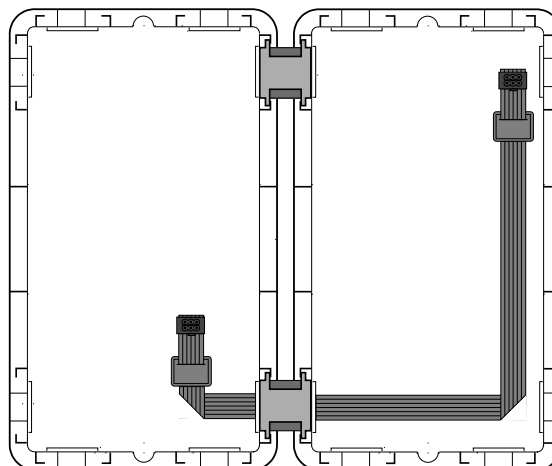
**Technical data**

Power supply: from the DUO line  
Power Consumption: 0.01A



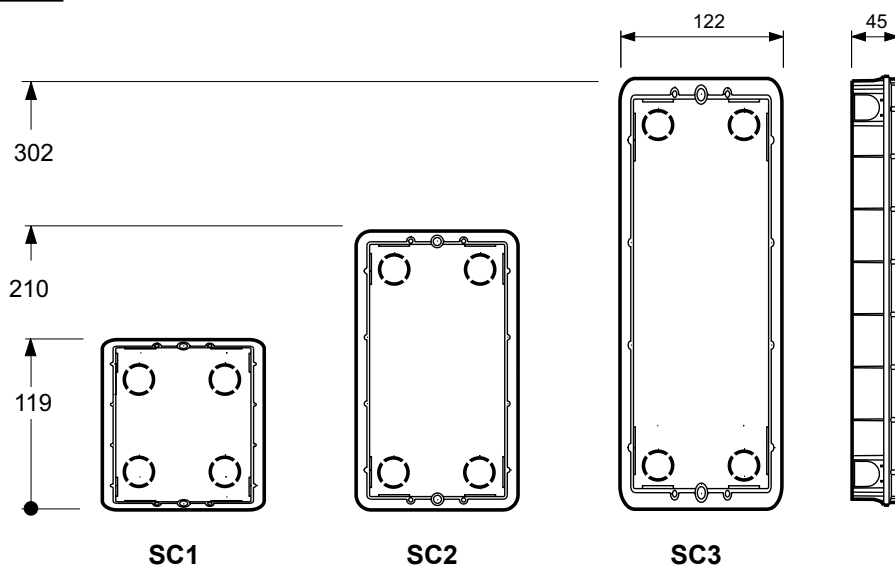
**EC733. Cable for the connection of Alba modules, length mm 560**

Connection cable between two CT2138AB modules when installed on two side-by-side frames (see figure).

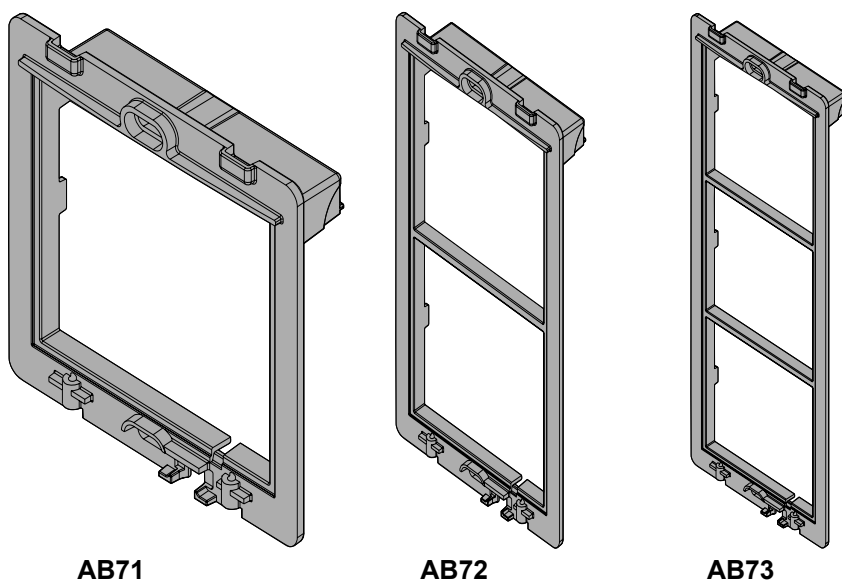


# POWERED FROM THE BUS EXTERNAL STATIONS

## SC1. SC2. SC3. Built-in boxes.

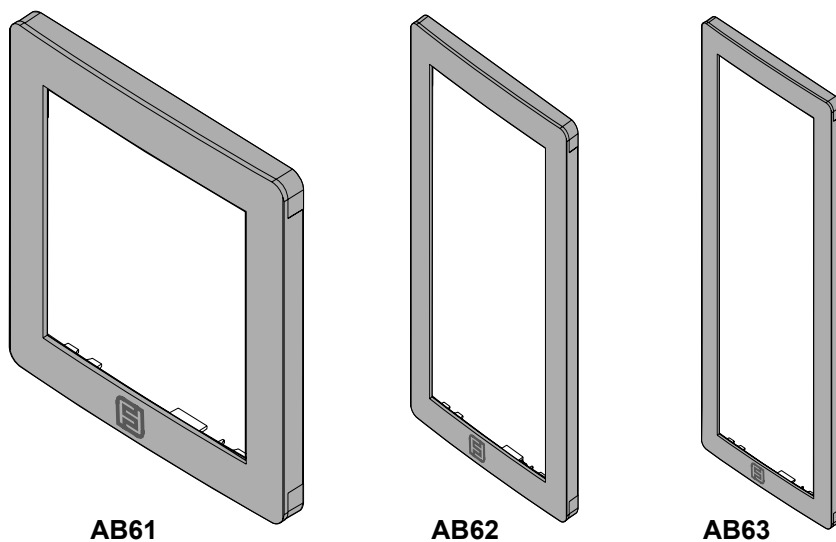


## AB71. AB72. AB73. Module frames.



	Dimensions
AB71	120x119x36 (W x H x D)
AB72	120x211x36 (W x H x D)
AB73	120x302x36 (W x H x D)

## AB61. AB62. AB63. Front frames.



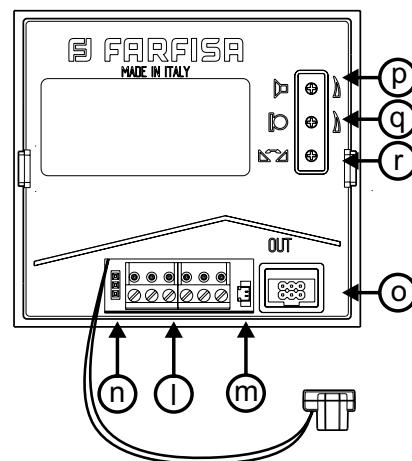
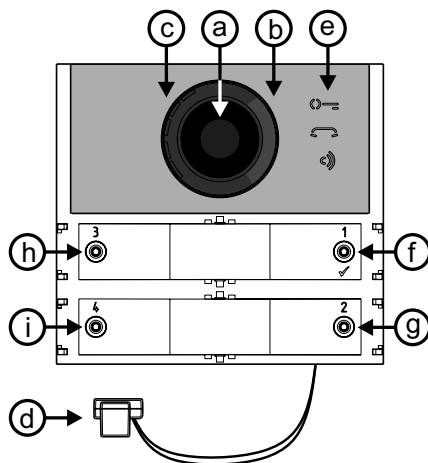
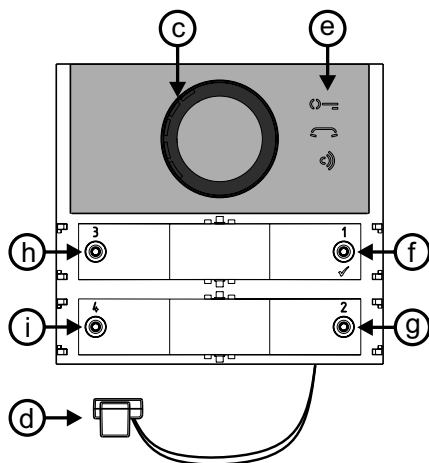
	Dimensions
AB61	124x124x11 (W x H x D)
AB62	124x216x11 (W x H x D)
AB63	124x307x11 (W x H x D)

LED SIGNALS AND ADJUSTMENTS

CA2124AB

CV2124AB

CA2124AB  
CV2124AB



LED Signals.

- Under normal operation:

- ON: lock released
- ON: call in progress
- ON: conversation in progress
- Quickly flashing: user or system busy

- In programming mode:

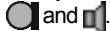
- Quickly flashing: awaiting sequence to enter the programming mode
- Quickly flashing: awaiting entering of programming codes
- Quickly flashing: awaiting entering value, address or pressing of call button
- ON for 3sec.: Saving in progress
- ON for 3sec.: module programmed for single-button operations
- ON for 3sec.: module programmed for double-button operations
- ON for 3sec.: return to factory settings.

Key

- a) Camera
- b) Lighting
- c) Speaker
- d) Microphone
- e) Notifications
- f) Call Button 1/√
- g) Call Button 2
- h) Call Button 3
- i) Call Button 4
- l) Extractable connection terminal block
- m) J13 - Contact C and NO connector auxiliary relay
- n) J3 - Programming connector
- o) J4 - Connector for connecting additional modules
- p) Speaker volume adjustment
- q) Microphone volume adjustment
- r) Feedback adjustment (Larsen effect)

Volumes adjustment

To adjust the volume of microphone and loudspeaker, turn the trimmers



Feedback adjustment

In case of "feedback" (Larsen effect) in the external unit it is necessary to operate as follow:

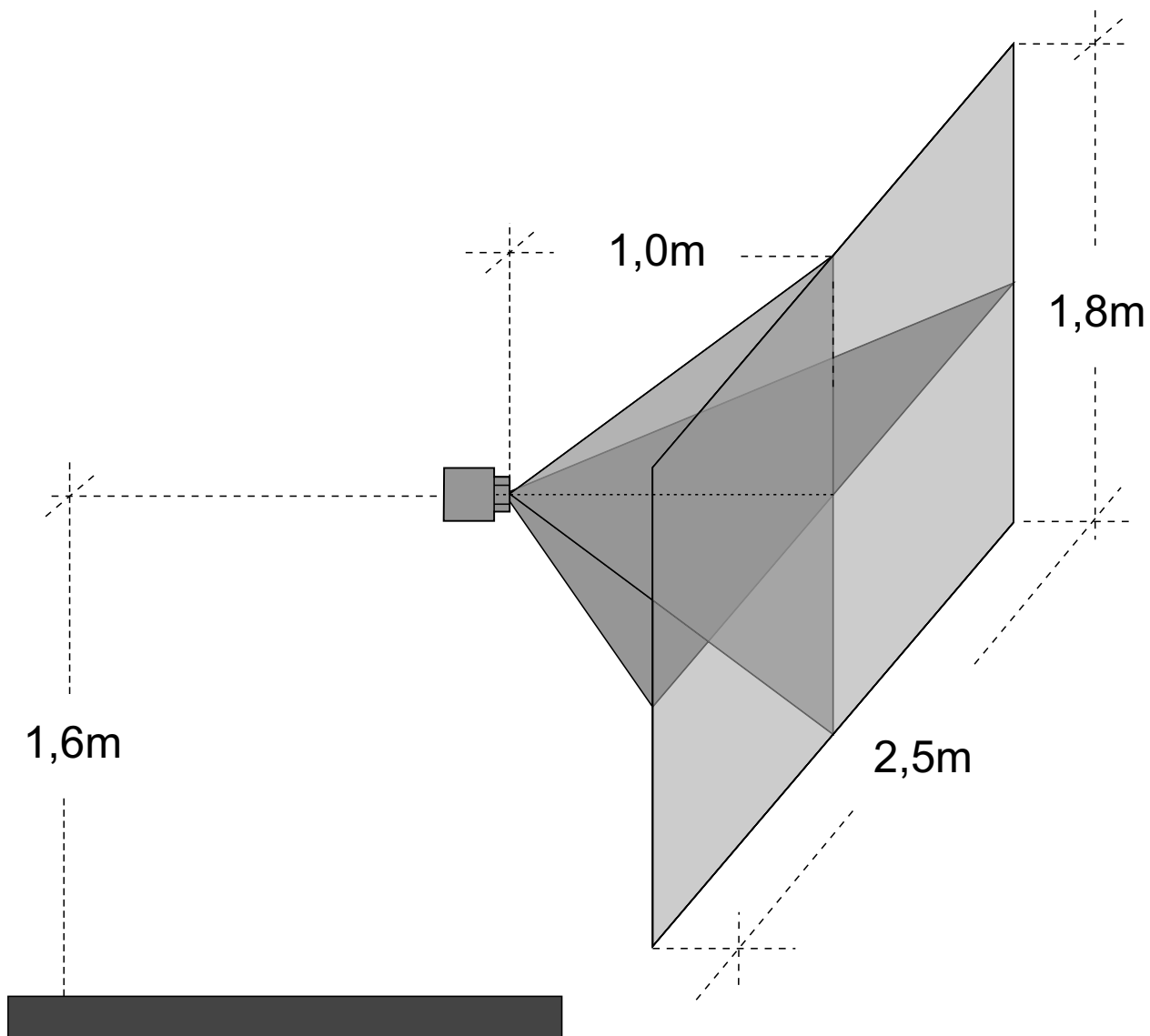
- make a call from the door station and lift the handset of the called user;
- remove the microphone from its housing in the push-button panel, place it on the loudspeaker and adjust the trimmer until the feedback stops;
- replace the microphone in its housing.

**Camera features (CV2124AB)**

Sensor:	CMOS 1/3"
Lens:	2.3mm
Focusing distance:	0,3m ÷ ∞
Min. illumination:	1,0 Lux



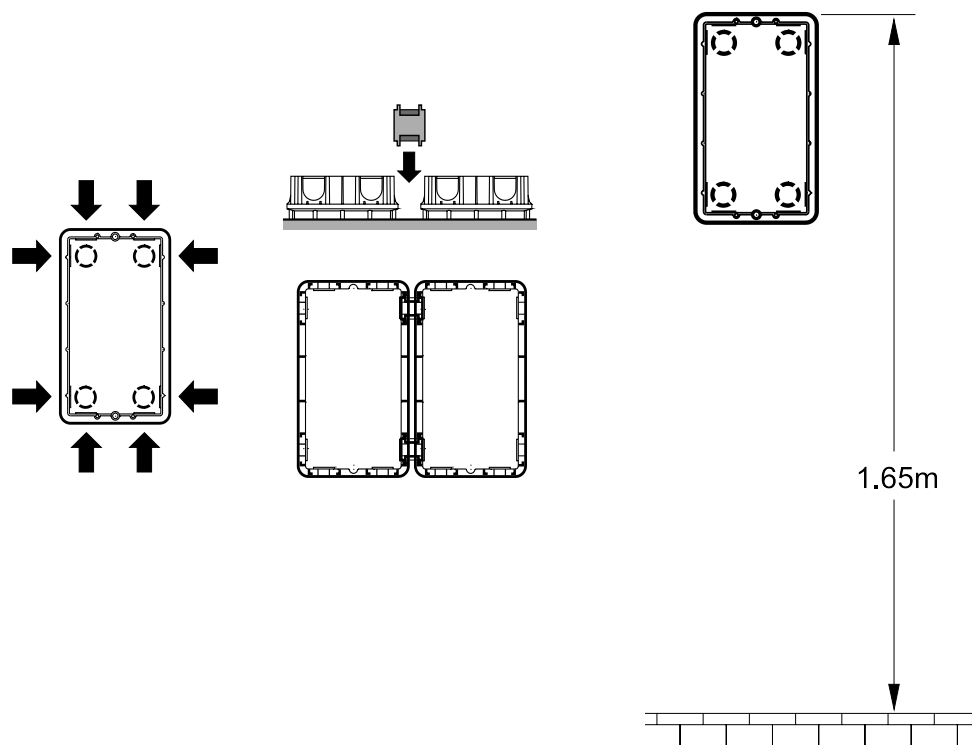
Position the camera unit so that solar rays or other direct light or intense reflections do not affect the camera lens.



## INSTALLATION

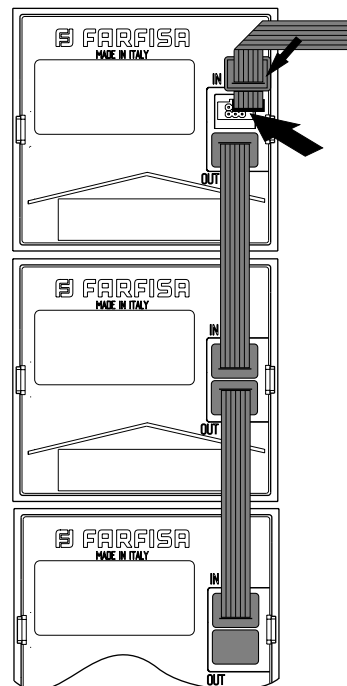
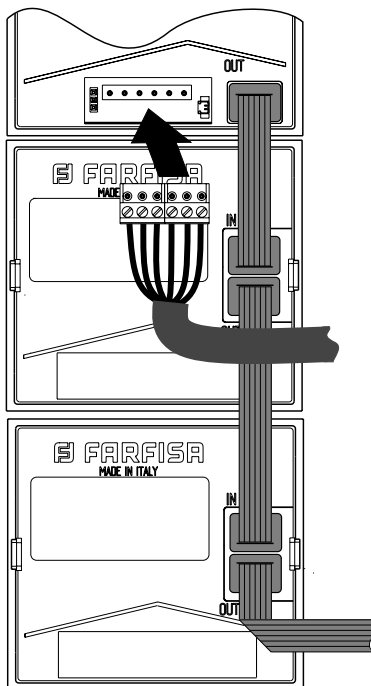
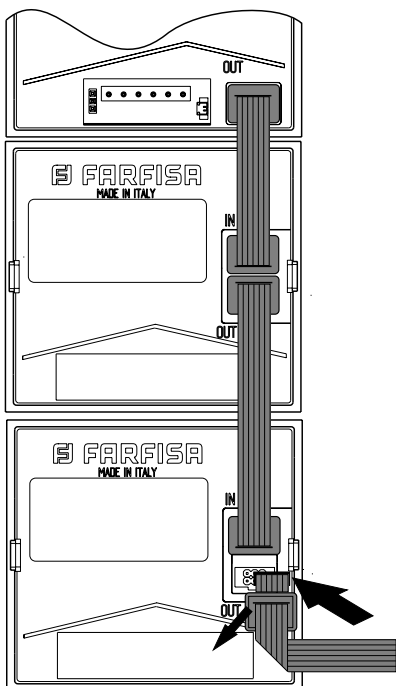
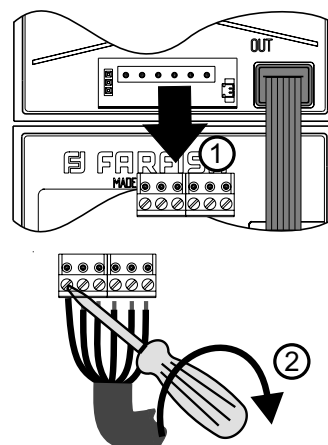
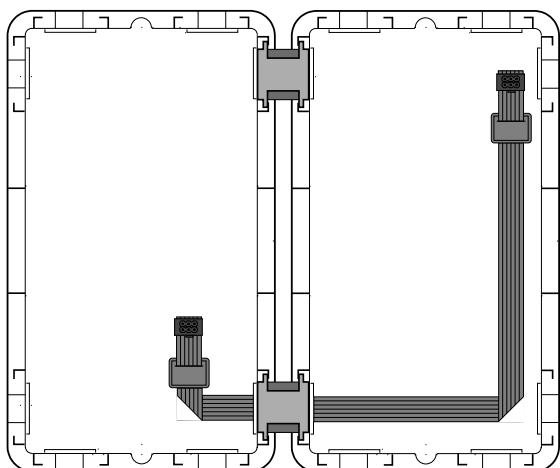
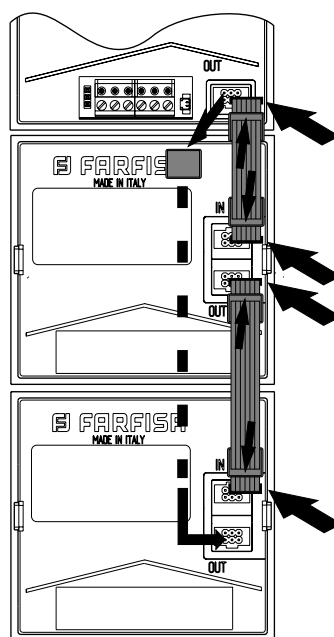
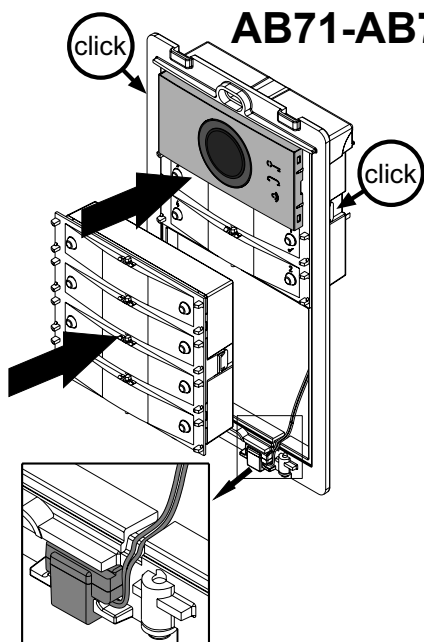
To mount the pushbutton panel, follow the instructions below:

- fix the recess box into the wall.
- Insert the modules into the frame in sequence (the audio-video module must be on top), paying attention to correctly position the microphone of the audio-video module in the slot located at the bottom of the frame.
- Connect the additional modules one after the other using the supplied flat cable.
- If necessary, between one box and the next, place the flat cable Art. EC733 along.
- Verify that the system is not powered by turning OFF the system's main power switch if necessary.
- Remove the audio-video module terminal block and connect it to the video intercom riser.
- When the frame is assembled go to the wall box and, if present, connect the long flat cable of the next wall box to the last module.
- Connect the terminal board to the audio-video module. If you are assembling the second or third wall box, connect the long cable from the previous box to the first module.
- Screw the frame to the wall box.
- Power the system ON by activating the system's main switch.
- Program the audio-video unit.
- Complete the installation of the mechanical parts (buttons, blank buttons, hood cover, etc..).

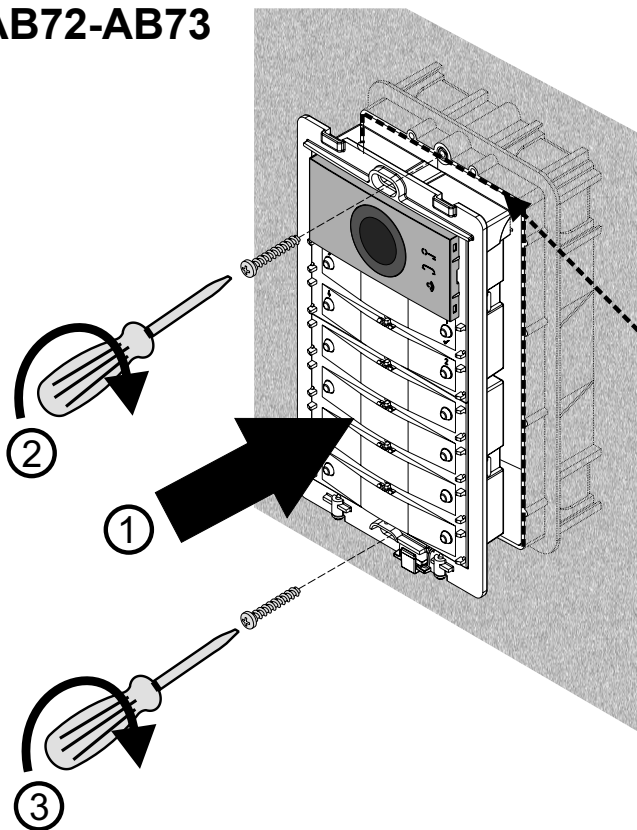


Position the door station unit in such a way that solar rays or other direct lights or intense reflections do not hit the camera lens (CV2124AB)..

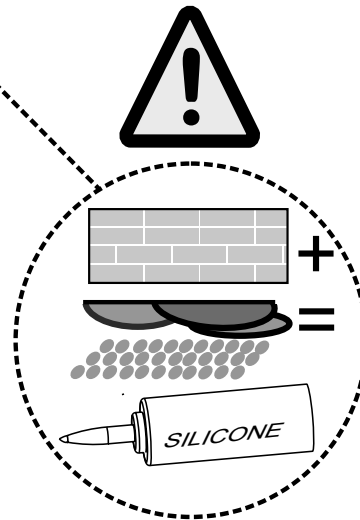
AB71-AB72-AB73



AB71-AB72-AB73



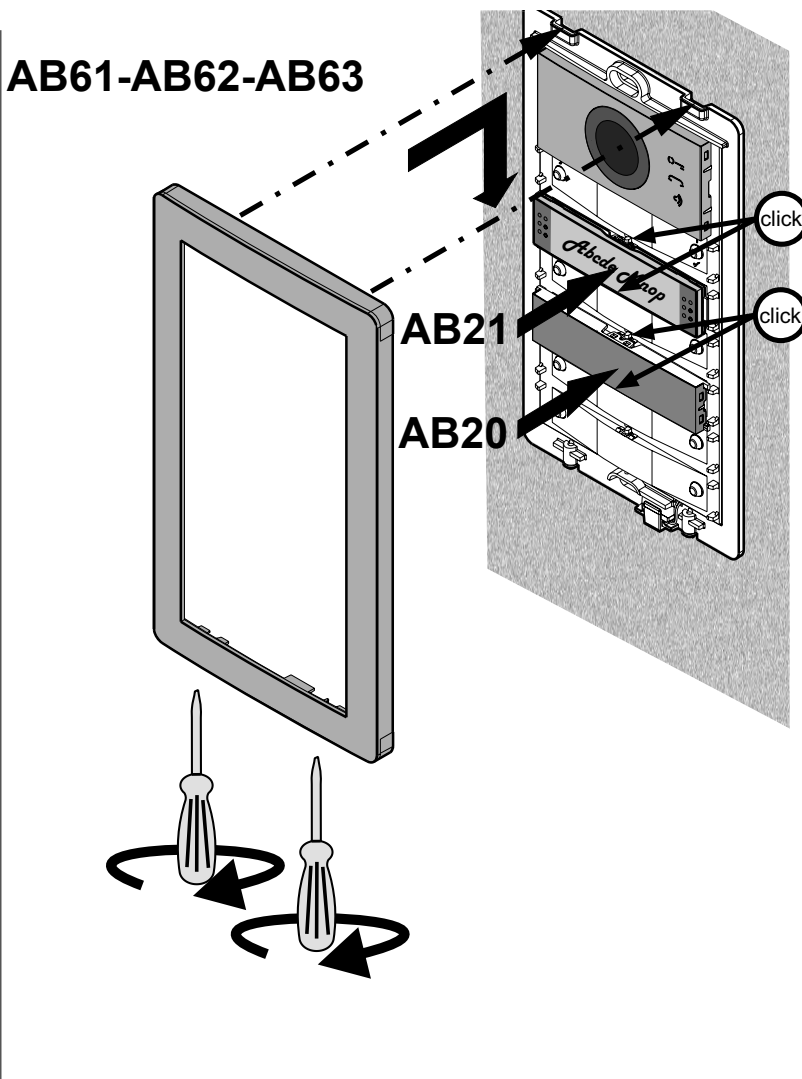
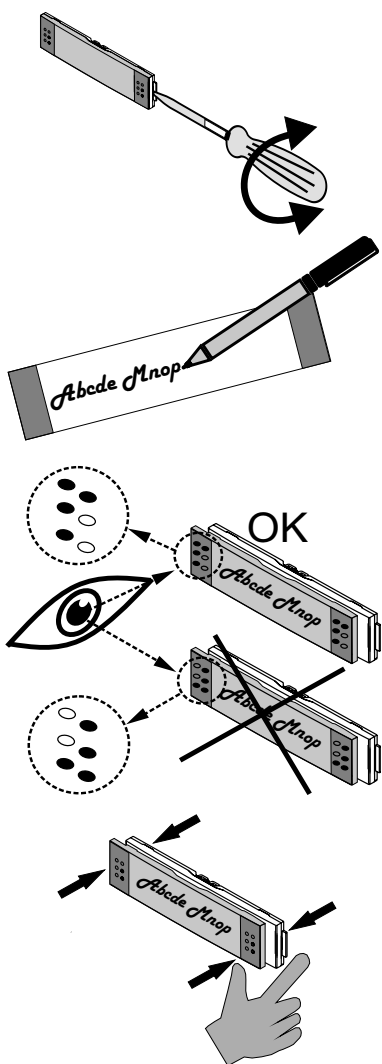
In the event that the wall surface is irregular, it is recommended to seal it properly before closing the panel completely.



DUO system

ALBA

AB61-AB62-AB63

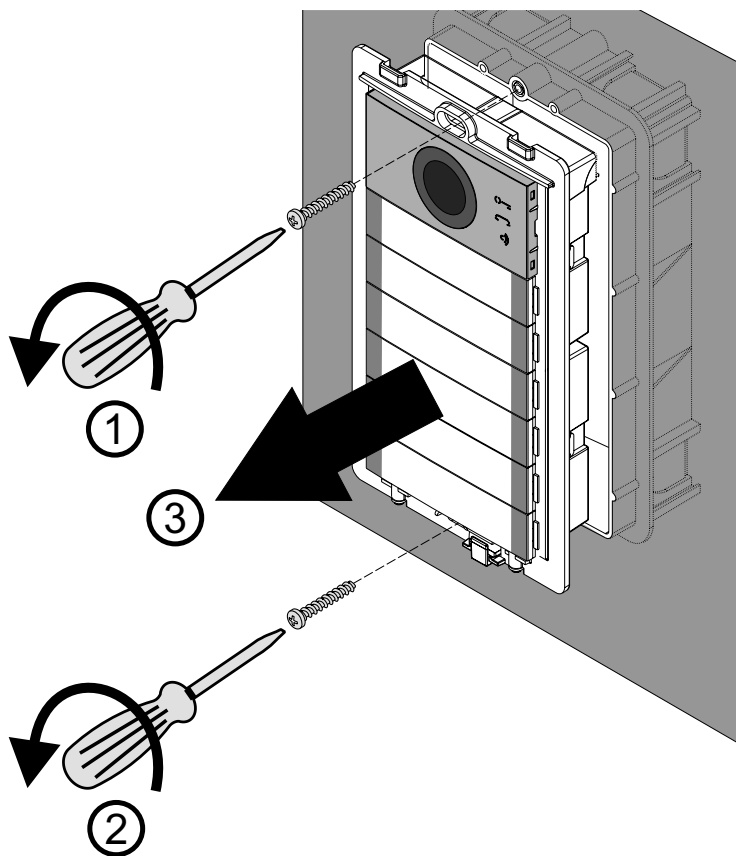
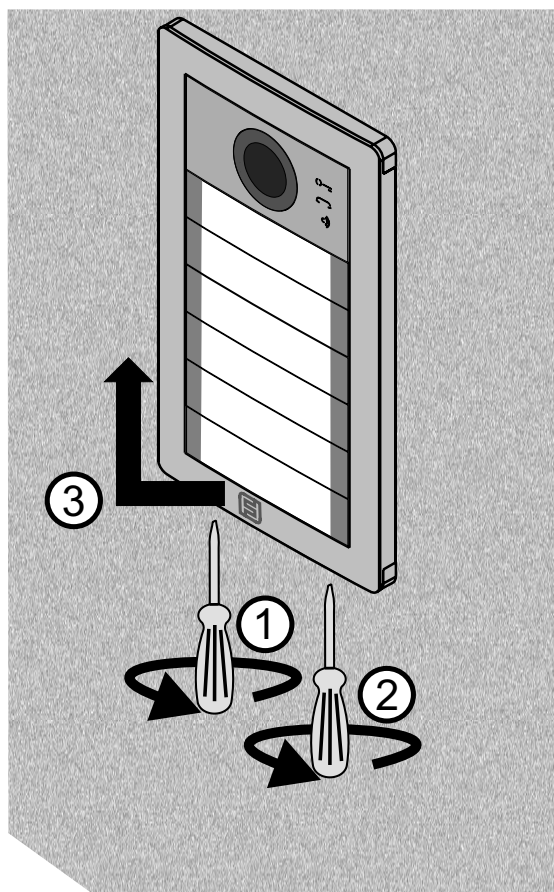




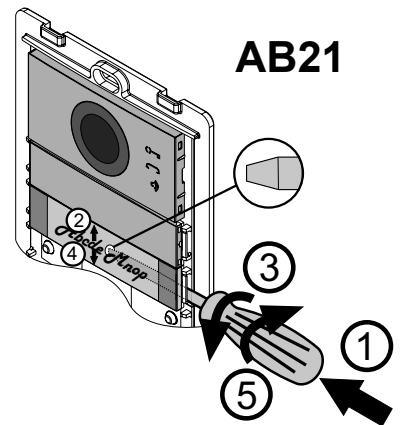
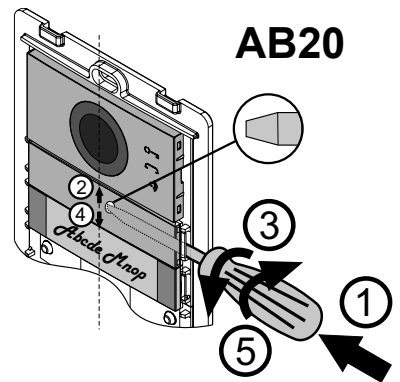
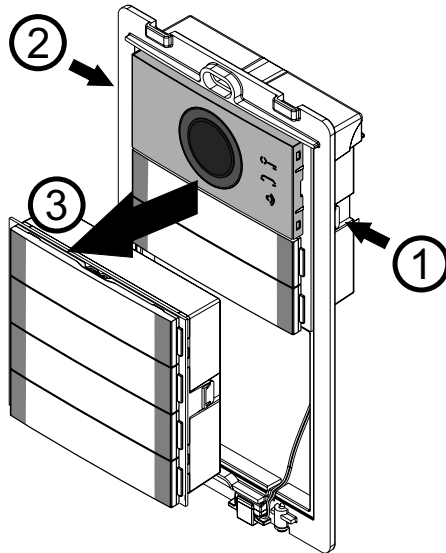
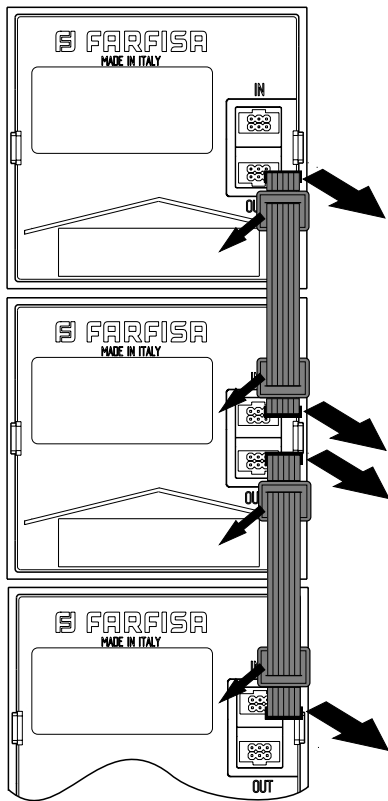
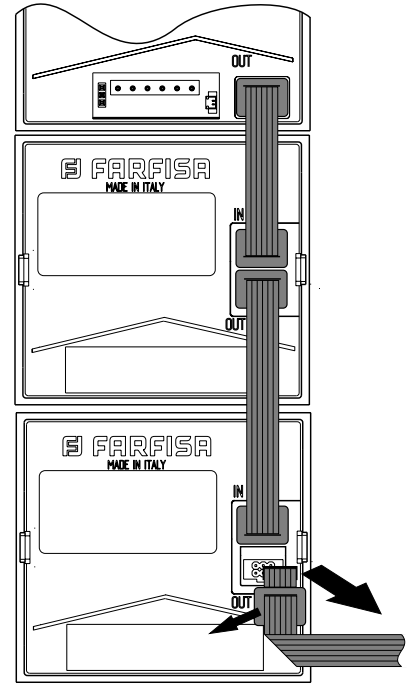
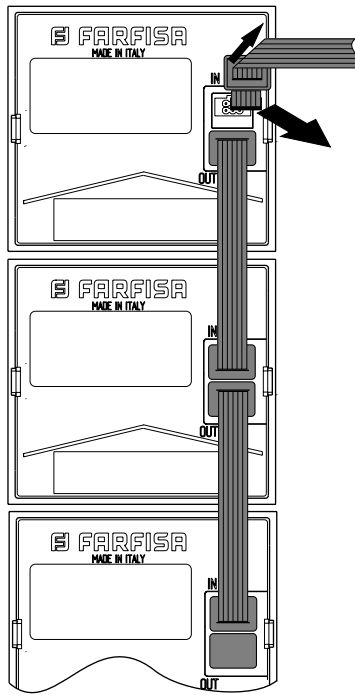
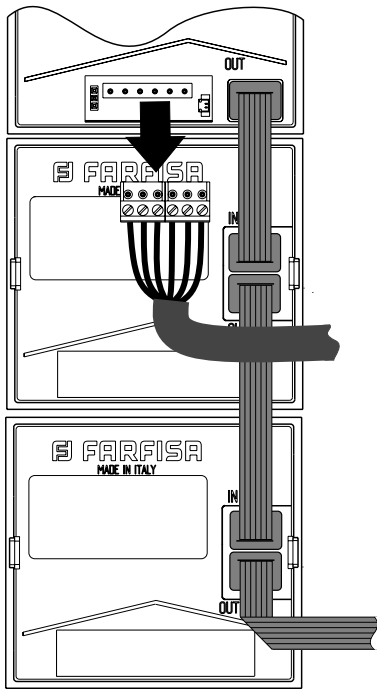
### Removing modules

To disassemble the modules follow the instructions below:

- switch OFF the power from the video intercom system by turning OFF the system's main switch.
- Remove the hood cover.
- Unscrew the frame from the box.
- Remove the terminal block from the audio-video module or, if it is the second or third wall box, remove the long flat cable from the first module. Remove any long flat cable from the last module that connects the module to the next wall box.
- Disconnect the flat cables connecting the modules to each other.
- Remove the modules.



# POWERED FROM THE BUS EXTERNAL STATIONS



**PROGRAMMING**

**"Extended Range" DUO Systems Block Address and Device Address (PDX1)**

The Audio CA2124AB and Audio-Video CV2124AB Modules are compatible with Extended Range DUO Farfisa digital systems as they support the possibility to divide the system into 99 blocks with 200 internal stations for each, therefore more than 19,000 devices can be installed in the system. To obtain such performance, each device must be identified by a Block Address (section of the system to which the device belongs: 001 to 099) and a Device Address (address programmed in the device: 001 to 200); Block 000 (i.e. unprogrammed block) is reserved for compatibility with existing DUO products and diagrams.

**External Video Modulators (PDX1)**

The Audio CA2124AB and Audio-Video CV2124AB Modules are designed to drive external video modulators (VM2521 type or similar) to which up to 8 additional cameras can be connected.

Each additional camera is managed as an External Unit and must have its own address within the range of addresses reserved to external units (from 231 to 253); these addresses must be stored in the VM1 to VM8 parameters of the audio-video module (codes 151 to 158).

Following the request of the video intercom system, the image of the camera on the module (by default=Main Camera) will be displayed first and then, cyclically, the additional cameras from VM1 to VM8 (if fewer cameras are saved, the display cycle will automatically take into account only the cameras saved); once the cycle has finished, it will start again with the display of camera on the module and so on. To change the camera with which the display sequence starts, you will need to store in the TP parameter (code 159) the address of the new main camera chosen from those stored in the VM1 to VM8 parameters. To reconfigure the camera on the module as the main camera, it is necessary to store the address 255 in the TP parameter.



**Factory settings**

The following are the values of the default factory settings, if you need to change them follow the instructions in the following paragraphs.

- Single button operation mode
- Main Camera (TP)=255 (camera on the module)
- Audio-Video module address=231
- Address associated with Button 1= 99
- Address associated with the First Button of the first additional pushbutton module (single button configuration)=101
- Electric Lock activation time=1 Second
- Special function buttons=none


**Entering programming mode**

Entering programming is only done with the unit in standby mode. To enter programming, you need to:

- simultaneously hold pressed keys 2 and 4 for 4 seconds;
- after the 4 sec. the module emits a tone and the  symbol starts flashing quickly;
- within 5 seconds press buttons 1, 2, 3 and 4 sequentially, the  symbol flashes quickly and the module emits a tone every 4 sec. to indicate that you are in programming mode.

**Exit programming mode**

To exit programming, you need to:

- simultaneously keep pressed keys 2 and 4 for 4 sec.;
- After 4 sec. the module emits a tone and the  symbol turns off.

**Entering codes and values**

To enter codes and values, use the keys 1/√ and 2; their use is as follows:

- 1/√: This button is pressed to confirm the entering of a code or to switch to another programming phase.
- 2: This button is pressed to increase the value of the digit to be entered. Press the button a number of times equal to the digit to be entered (digit 1=1 press, digit 9=9 presses, digit 0=10 presses of the button).

Button pressing is confirmed by a tone.

**Notes on entering codes and values**

- The codes and values to be entered must be always formed by three digits (hundreds, tens, and units); codes and values that are composed of tens and units or units alone must be completed by adding zeros. For example, number 96 becomes 096 and number 5 becomes 005.
- The digits must be entered one by one by pressing "n" times the "2" button, where "n" corresponds to the value of the digit to be entered, followed by a pause of about 2 seconds to switch to the next digit (a tone will indicate when switching to entering the next digit). For example, to enter number 096 you need to:
  - press the "2" button 10 times to enter the digit 0 and wait for 2 seconds until you hear a tone;
  - press the "2" button 9 times to enter digit 9 and wait for 2 seconds until you hear a tone;
  - press the "2" button 6 times to enter the digit 6 and wait for 2 seconds until you hear a tone.

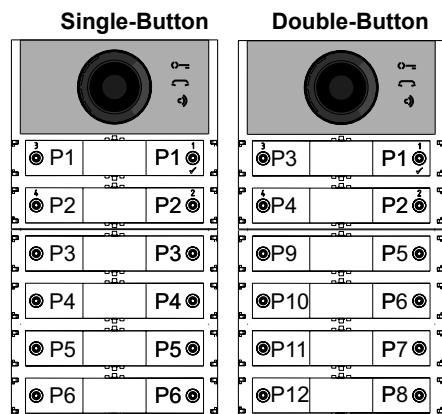
**Attention:** after composing the number, always remember to confirm the entry by pressing the key 1/√.

**Configuring call buttons of the Door Station**





With the following programming it is possible to select the configuration of the buttons of the Door Station (default setting is single-button mode).

**Single-button or double-button**

The audio-video module and the additional button modules connected to it (up to 8) can work as:

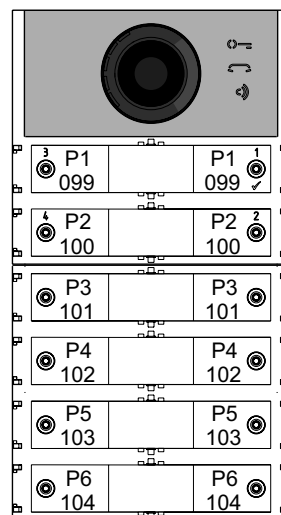


To make the selection you need to:

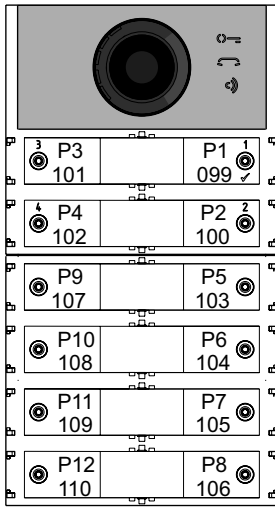
- Enter programming.
- For single-button operation, simultaneously press for 4 sec. keys 1 and 2, the module emits a tone and the 2 symbols  and  are lit simultaneously for 2 sec.
- For double-button operation, simultaneously press for 4 sec. keys 1 and 3, the module emits a tone and the 2 symbols  and  are lit simultaneously for 2 sec.
- Exit programming.

**Attention:** the programming is active both on the audio-video module and on all the additional button modules connected to it.

**In the case of selecting single-button operation, by default, the buttons will call the following addresses:**



In the case of selecting double-button operation, by default, the buttons will call the following addresses:



**Programming of the Audio-Video Module**

The programming of the Audio-Video Module is carried out by entering the programming code followed by its value; codes are shown in table 1.

**Table 1**  
**Programming codes**

- 000 Return to factory settings with the exception of the addresses associated with the call buttons.
- 001 Return to factory settings of the addresses associated with the call buttons.
- 111 Address of the Audio-Video Module.
- 112 Block address valid for all call buttons.
- 113 Automatic sequential allocation of device address for all call buttons.
- 121 Enable tone while electrical lock is opening
- 122 Switching OFF the video signal while electrical lock is opening.
- 123 Activate auxiliary relay with PB-GN contact.
- 124 Sending door opened warning code.
- 128 Extend maximum talk time to 8 minutes.
- 131 Electrical lock activation time.
- 132 Auxiliary relay activation time.
- 142 Presence of door keeper exchangers
- 148 Auxiliary relay block address.
- 149 Auxiliary relay device address.
- 151 Address of the first video camera associated with the external unit (VM1).
- 152 Address of the second video camera associated with the external unit (VM2).
- 153 Address of the third video camera associated with the external unit (VM3).
- 154 Address of the fourth video camera as-

- 155 Address of the fifth video camera associated with the external unit (VM5).
- 156 Address of the sixth video camera associated with the external unit (VM6).
- 157 Address of the seventh video camera associated with the external unit (VM7).
- 158 Address of the eighth video camera associated with the external unit (VM8).
- 159 Selection of the main camera associated with the Audio-Video module (TP).
- 180 Block address of the first group first user NO Video (U1<sub>(b)</sub> start).
- 181 Device address of the first group first user NO Video (U1<sub>(a)</sub> start).
- 182 Block address of the first group last user NO Video (U1<sub>(b)</sub> stop).
- 183 Device address of the first group last user NO Video (U1<sub>(a)</sub> stop).
- 184 Block address of the second group first user NO Video (U2<sub>(b)</sub> start).
- 185 Device address of the second group first user NO video (U2<sub>(a)</sub> start).
- 186 Block address of the second group last user NO Video (U2<sub>(b)</sub> stop).
- 187 Device address of the second group last user NO Video (U2<sub>(a)</sub> stop).

- 221 Block address for the single call button.
- 222 Device address for the single call button.
- 223 Block address for all buttons starting from the one in the programming.
- 224 Automatic sequential assignment of device addresses to call buttons starting from the one in the programming.

**Programming procedure**

To carry out the programming, you need to:

- **Enter the programming mode** following the indications in the "Enter Programming Mode" section, the symbol will start flashing quickly notifying the operator that the device is awaiting the programming code;
- **identify the programming code to use** (see table 1);
- **enter the three digits of the programming code you intend to use** following the instructions in the "entering codes and values" section;
- **press 1/√ to confirm:** you will hear a tone, the symbol will stop flashing, and the symbol will start to flash quickly notifying the operator that the device is awaiting the value;
- **enter the new value**, following the instructions in the "Entering Codes and Values" section;
- **press 1/√ to confirm:** you will hear a tone and the symbol will stop flashing and the symbol will flash quickly, notifying the operator that the device is awaiting a new programming code;

- **continue** by entering the code of another programming or exit, following the instructions in the "Exit Programming Mode" section.

**Return to factory setting of all parameters of the Audio-Video Module except for the addresses associated with the call buttons (000 code)**

With this programming, all module parameters will return to their factory value (factory values are listed at the beginning of the "Programming" section). The addresses associated with the call buttons will not be changed.

- Enter code 000;
- press button 1/√ to confirm;
- Enter value 123;
- press button 1/√, to confirm, the device emits a tone and the , and symbols will light up for 2 sec. indicating that the parameter values have returned to default factory settings.

**Return to factory settings of all the addresses associated with the call buttons of the Audio-Video Module and any Additional Push-Buttons Modules (code 001)**

With this programming, all of the Block and Device addresses assigned to call buttons will return to their factory value (factory values are listed at the beginning of the "Programming" section). The other parameters programmed in the Audio-Video module will not be changed.

- Enter code 001;
- press button 1/√ to confirm;
- Enter value 123;
- press button 1/√, to confirm, the device emits a tone and the , and symbols will light up for 2 sec. indicating that the addresses associated with the call buttons have returned to factory values.

**Audio-Video Module Address (code 111)**

It is possible to store the address of the Audio-Video module (factory setting 231, addresses allowed between 231 and 250).

- Enter code 111;
- press button 1/√ to confirm;
- enter the new address of the external unit;
- press button 1/√ to confirm;
- continue with the next programming or exit programming.

**Programming sequential addresses in the call buttons (codes 112-113).**

In extended range DUO systems, each user must be identified by a Block Address (000 to 099) and a unique or Device Address (001 to 200), with the following programming it is possible to assign to all call buttons of the external unit (both the audio-video and any additional push-button modules) a single Block Address and, automatically, a sequential incremental Device Address starting from the button 1 of the audio-video module.

**⚠ Attention:** the sequential numbering will be congruent with the previously selected configuration of call buttons for the door station (single-button or double-button).

**Block Address valid for all call buttons (code 112)**

To program the Block Address valid for all call buttons (factory setting 000; block addresses allowed between 000 and 099).

- Enter code 112;
- press button1/√ to confirm;
- enter the new Block Address valid for all call buttons;
- press button1/√ to confirm;
- continue with the next programming or exit programming.

**Sequential Device Addresses for all call buttons (code 113)**

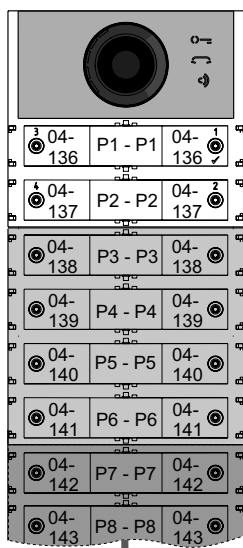
To program with sequential Device Addresses of all the call buttons in the external unit, you must program the Device Address from button 1 of the audio-video module (factory setting 099; addresses allowed from 001 to 200); the other buttons on the audio-video module and an additional button modules will call up sequential incremental Device Addresses depending on the order they were connected.

To carry out the programming, you need to:

- Enter code 113;
- press button1/√ to confirm;
- enter the new Device Address to be assigned to button 1 of the audio-video module;
- press button1/√ to confirm, the audio-video module buttons and all the additional button modules connected to it will automatically assume a progressive incremental address starting from the device address assigned to button 1 (see examples below);
- continue with the next programming or exit programming.

**Example:** Block Address 004 and Device Address of button P1 = 136, the following buttons will call the following addresses:

**single button**



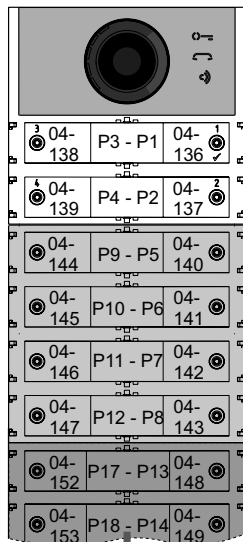
From 3rd to 8th button module

Audio-video module

1st Button module

2nd Button module

**double button**



From 3rd to 8th button module

Audio-video module

1st Button module

2nd Button module

**Enable tone while electrical lock is opening (code 121)**

By enabling the function, the audio-video module emits a notification tone for the entire period for which the lock is activated.

- Enter code 121;
- press button1/√ to confirm;
- to enable the function enter the value 111; to disable the function enter the value 222;
- press button1/√ to confirm;
- continue with the next programming or exit programming.

**Turning OFF video signal while lock is opening (code 122)**

By enabling the function, the audio-video module automatically turns OFF the video signal for the entire period for which the lock is activated. This function is used to optimise the use of energy during lock opening.

- Enter code 122;
- press button1/√ to confirm;
- to enable the function enter the value 111; to disable the function enter the value 222;
- press button1/√ to confirm;
- continue with the next programming or exit programming.

**Enabling the activation of the auxiliary relay with PB-GN contact (code 123)**

By enabling this function when closing the PB-GN contacts, instead of activating the electrical lock (terminals S+ and S-), is activated the auxiliary relay and contacts C and NO of J13 will be closed.

- Enter code 123;
- press button1/√ to confirm;
- to enable the function enter the value 111; to disable the function enter the value 222;
- press button1/√ to confirm;
- continue with the next programming or exit programming.

**Sending warning code "door is opened" (code 124)**

After enabling this function when closing the PB-GN contacts, the audio-video module, instead of activating the electric lock connected to the S+ and S- terminals, transmits on BUS DUO the "door is opened" warning code; disconnecting the contacts, the audio-video module sends the "door is closed" code.

To enable this function you need to:

- enter code 124;
- press button1/√ to confirm;
- to enable the function enter the value 111; to disable the function enter the value 222;
- press button1/√ to confirm;
- continue with the next programming or exit programming.

**Maximum talk time 8 minutes (code 128)**

By enabling this function, the maximum talk time increases from 1.5 minutes (factory value) to 8 minutes.

- Enter code 128;
- press button1/√ to confirm;
- to enable the function enter the value 111; to disable the function enter the value 222;
- press button1/√ to confirm;
- continue with the next programming or exit programming.

**Electrical Lock opening time (code 131)**

The lock opening time can be varied as follows:

- enter code 131;
- press button1/√ to confirm;
- enter the new activation time (factory setting 1 sec; allowed values 001-099 sec.);
- press button1/√ to confirm;
- continue with the next programming or exit programming.

**Auxiliary relay activation time (code 132)**

The activation time of the auxiliary relay can be varied as follows:

- enter code 132;
- press button1/√ to confirm;
- enter the new activation time (factory setting 3 sec; allowed values 000-099 sec.);

**⚠ Attention:** saving time as 000 the relay acts as a bistable;

- press button1/√ to confirm;
- continue with the next programming or exit programming.

**Presence of door keeper exchangers (code 142)**

The door station must be suitably programmed depending on whether it should send calls directly to the users or to a main or secondary door keeper exchanger; to carry out the programming it is necessary to store the address 201 if the door station has to call main door keeper exchangers or 210 if the door station has to call secondary door keeper exchangers. The 255 value indicates that no door keeper exchanger is present and calls are sent directly to the users.

3A

system

ALBA

To run the programming:

- enter code 142;
- press button1/√ to confirm;
- enter the address 201, 210 or 255 (factory setting 255=no door keeper exchanger; allowed values 201 to send calls to main door keeper exchangers, 210 to send calls to secondary door keeper exchangers or 255 to send calls directly to the users);
- press button1/√ to confirm;
- continue with the next programming or exit programming.

**Auxiliary relay address (codes 148-149)**

On the J13 connector there is a common contact (C) and normally open contact (NO) of the internal auxiliary relay; by factory setting, the auxiliary relay is not accessible (address 255), so the audio-video module must be suitably programmed to use it. An actuator address (211 to 230) or a user address (000 to 200) can be assigned to the auxiliary relay, depending on the address saved, the auxiliary relay behaves differently:

- **Actuator address.** By saving the address of an actuator, therefore a block address from 000 to 099 and device address from 211 to 230, the auxiliary relay acts as an actuator and, when called, it activates with the mode set in the programming "Auxiliary relay activation time" (code 132).
- **User address.** By saving an address of a user, therefore a block address from 000 to 099 and user address from 000 to 200, the auxiliary relay only activates when the lock opening command arrives from a user having an address equal to or greater than the one saved; If you store the address 000-000, the auxiliary relay will activate upon arrival of the lock opening command of any user. The activation mode is that set in the programming "Auxiliary relay activation time" (code 132).

**Auxiliary relay Block Address (code 148)**

- Enter code 148;
- press button1/√ to confirm;
- enter the Block Address that is to be assigned to the relay (factory setting 255 which means an unprogrammed Block Address; allowed values from 000 to 099);
- press button1/√ to confirm;
- continue with the next programming or exit programming.

**Auxiliary relay Device Address (code 149)**

- Enter code 149;
- press button1/√ to confirm;
- enter the Device Address that is to be assigned to the relay (factory setting 255 which means an unprogrammed Device Address; admissible values from 000 to 200 or 211 to 230);
- press button1/√ to confirm;
- continue with the next programming or exit programming.

**Programming additional cameras associated with the external unit (codes 151-152-153-154-155-156-157-158) and main video camera (code 159)**

The CA2124AB and CV2124AB modules can drive external video modulators (type VM2521) to which up to eight additional cameras can be connected, for details see "External Video Modulators (PDX1)" section. In the case of additional cameras, the addresses of the video modulators present in the installation and, if necessary, the address of the main video camera (TP) must be programmed.

**Programming additional camera addresses VM1 ÷ VM8 (codes 151-152-153-154-155-156-157-158)**

- To program the address of the first additional camera VM1 enter code 151;
- press button1/√ to confirm;
- enter the address of the first additional camera (the addresses of the additional cameras must also be stored in the video modulators to which the cameras are connected and must be selected from those reserved for external units: from 231 to 253);
- press button1/√ to confirm;
- if required, proceed in the same programming the address of other additional cameras:
- Code 152: entry address of VM2**
- Code 153: entry address of VM3**
- Code 154: entry address of VM4**
- Code 155: entry address of VM5**
- Code 156: entry address of VM6**
- Code 157: entry address of VM7**
- Code 158: entry address of VM8**
- otherwise continue with other programming or exit.

**Selecting main camera (code 159)**

The main camera (TP) is the camera from which the audio-video module starts the cyclic scan of the associated cameras, for selecting the camera you need to:

- enter code 159;
- press button1/√ to confirm;
- enter the address of the main camera (the one from which the cyclic display sequence starts) chosen between the VM1÷VM8 addresses programmed earlier. If the main camera must be the one on the audio-video module (factory setting), the address to be stored is 255;
- press button1/√ to confirm;
- continue with the next programming or exit programming.

**User programming NO Video (codes 180-181-182-183-184-185-186-187)**

With the following programming you can define two groups of users who must not receive the video signal (for example, only intercom users); the two groups are identified by the start and end group user address.

The 1st Group is identified by the Block (b) and Device Address (d) of the first user belonging to the group:

U1<sub>(b)</sub> Start + U1<sub>(d)</sub> Start and from the Block (b) and Device (d) address of the last user in the group:

U1<sub>(b)</sub> Stop + U1<sub>(d)</sub> Stop.

The 2nd Group is identified in exactly the same way with the parameters:

U2<sub>(b)</sub> Start + U2<sub>(d)</sub> Start

and

U2<sub>(b)</sub> Stop + U2<sub>(d)</sub> Stop.

All users whose addresses are in one of two groups, if called, will not receive the video signal. To delete any groups that are no longer required, it is necessary to store both as Block Address and Device Address of the Start group user the value 255 (U1<sub>(b)</sub> start=U1<sub>(d)</sub> start=255 and/or U2<sub>(b)</sub> start=U2<sub>(d)</sub> start=255).

**Programming U1<sub>(b)</sub> Start (code 180) and U1<sub>(d)</sub> Start (Code 181)**

Enter the Block and Device Address of the first user belonging to the first NO Video group.

**Block Address U1<sub>(b)</sub> Start (code 180)**

- Enter code 180;
- press button1/√ to confirm;
- enter the Block Address that is to be assigned to the first user of the group NO Video (factory setting 255 which means an unprogrammed block address; allowed values from 000 to 099);
- press button1/√ to confirm;
- continue with the programming of the Device Address of the first user belonging to the first NO Video group.

**Device Address U1(d)start (code 181)**

- Enter code 181;
- press button1/√ to confirm;
- enter the Device Address that is to be assigned to the first user of the group NO Video (factory setting 255 which means an unprogrammed block address; allowed values from 000 to 200);
- press button1/√ to confirm;
- continue programming the address of the last user address belonging to the first NO Video group (U1<sub>(b)</sub> Stop).

**Programming U1<sub>(b)</sub> Stop (code 182) and U1<sub>(d)</sub> Stop (code 183)**

Enter the Block and Device Address of the last user belonging to the first NO Video group.

**Block Address U1<sub>(b)</sub> Stop (code 182)**

- Enter code 182;
- press button1/√ to confirm;
- enter the Block Address that is to be assigned to the last user of the NO Video group (factory setting 255 which means an unprogrammed block address; allowed values from 000 to 099);
- press button1/√ to confirm;
- continue with the programming of the Device Address of the last user belonging to the first NO Video group.

**Device Address U1<sub>(a)</sub> Stop (code 183)**

- Enter code 183;
- press button1/√ to confirm;
- enter the Device Address that is to be assigned to the last user of the first NO Video group (factory setting 255 which means an unprogrammed device address; allowed values from 000 to 200);
- press button1/√ to confirm;
- continue with the next programming or exit programming.

**Programming U2<sub>(b)</sub> Start (code 184) and U2<sub>(a)</sub> Start (code 185)**

Enter the Block and Device Address of the first user belonging to the second NO Video group.

**Block Address U2<sub>(b)</sub> Start (code 184)**

- Enter code 184;
- press button1/√ to confirm;
- enter the Block Address that is to be assigned to the first user of the second NO Video group (factory setting 255 which means an unprogrammed block address; allowed values from 000 to 099);
- press button1/√ to confirm;
- continue with the programming of the Device Address of the first user belonging to the second NO Video group.

**Device Address U2<sub>(a)</sub> Start (code 185)**

- Enter code 185;
- press button1/√ to confirm;
- enter the Device Address that is to be assigned to the first user of the second NO Video group (factory setting 255 which means an unprogrammed device address; allowed values from 000 to 200);
- press button1/√ to confirm;
- continue with the programming of the address of the last user belonging to the second NO Video group.

**Programming U2<sub>(b)</sub> Stop (code 186) and U2<sub>(a)</sub> Stop (code 187)**

Enter the Block and Device Address of the last user belonging to the second NO Video group.

**Block Address U2<sub>(b)</sub> Stop (code 186)**

- Enter code 186;
- press button1/√ to confirm;
- enter the Block Address that is to be assigned to the last user of the second NO Video group (factory setting 255 which means an unprogrammed block address; allowed values from 000 to 099);
- press button1/√ to confirm;
- continue with the programming of the Device Address of the last user belonging to the second NO Video group.

**Device Address U2<sub>(a)</sub> Stop (code 187)**

- Enter code 187;
- press button1/√ to confirm;
- enter the Device Address that is to be assigned to the last user of the second NO Video group (factory setting 255 which means an unprogrammed device address; allowed values from 000 to 200);

- press button1/√ to confirm;
- continue with the next programming or exit programming.

**Special programming for call buttons (codes 221-222-223-224)**

In order to make easier the programming of the call buttons, special procedures for storing addresses are available when a flexible numbering is required.

**Programming call buttons with specific addresses (codes 221-222)**

With the following procedure you can store a specific address on each call button, therefore not tied to a sequential numbering. The address must be composed of the Block Address and the Device Address.

**Blockadresse (Code 221)**

- Enter code 221;
- press button1/√ to confirm;
- enter the Block Address that is to be assigned to a specific button (values allowed from 000 to 099);
- hold pressed the button to which the address is to be assigned, after 4 sec. you will hear a tone, symbol  $\overleftarrow{\text{C}}$  will stop flashing while symbol  $\overrightarrow{\text{C}}$  will resume flashing quickly;
- continue with the programming of the Device Address.

**Device Address (code 222)**

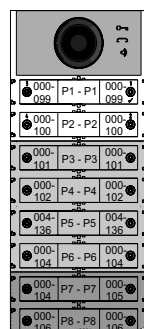
- Enter code 222;
- press button1/√ to confirm;
- enter the Device Address that is to be assigned to a specific button (values allowed from 001 to 230);
- hold pressed the button to which the address is to be assigned, after 4 sec. you will hear a tone, symbol  $\overleftarrow{\text{C}}$  will stop flashing while symbol  $\overrightarrow{\text{C}}$  will resume flashing quickly;
- continue with the next programming or exit programming.

**Example:** to store the Block Address 004 and the Device Address 136 in the P5 button, and keep the original numbering for all the other buttons, follow these steps:

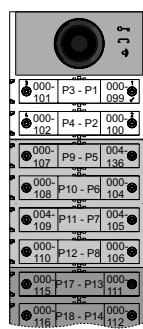
$$221+P1+004+P5(>4sec.)+222+P1+136+P5>4\text{ sec.}$$

After the procedure, the buttons will call the following addresses:

Single button



Double button



**Programming of call buttons using address groups (codes 223-224).**

To speed up address storage in call buttons when the system is made up of separate buildings, you can use the group programming procedure that allows to automatically and sequentially encode the call buttons starting from a specific button. The address must be composed of the Block Address and the Device Address.

**Attention:** the sequential numbering will be congruent with the configuration of the external unit call buttons (single-button or double-button).

**Block Address (code 223)**

- Enter code 223;
- press button1/√ to confirm;
- enter the Block Address that is to be assigned starting from a specific button, the Block Address will also apply to all subsequent buttons (values allowed from 000 to 099);
- hold pressed the button from which it is intended to start with the numbering, after 4 sec. you will hear a tone, symbol  $\overleftarrow{\text{C}}$  stops flashing and symbol  $\overrightarrow{\text{C}}$  starts flashing quickly;
- continue with the programming of the Device Address.

**Device Address (code 224)**

- Enter code 224;
- press button1/√ to confirm;
- enter the Device Address that is to be assigned starting from a specific button, the subsequent buttons will automatically receive a sequential Device Address (values allowed from 001 to 200);
- hold pressed the button from which it is intended to start with the numbering, after 4 sec. you will hear a tone, symbol  $\overleftarrow{\text{C}}$  stops flashing and symbol  $\overrightarrow{\text{C}}$  starts flashing quickly.

Repeat the same procedure for all the groups of buttons in which the installation is divided.

**Attention:** to use the procedure correctly it is necessary to start programming the buttons from those at the top (see next example) and remember that the sequential numbering will be congruent with the configuration of the door station call buttons (single-button or double-button).

**Example:** to divide the pushbutton into three groups so that the P1 and P2 buttons call the addresses stored in the factory settings (Block 000 Device 099 and Block 000 Device 100), and buttons from P3 to P6 call users with Block Address 004 and Device Addresses from 136 to 139 and the buttons from P7 onward call users with Block Address 007 and Device Addresses from 150 onward, proceed as follows:

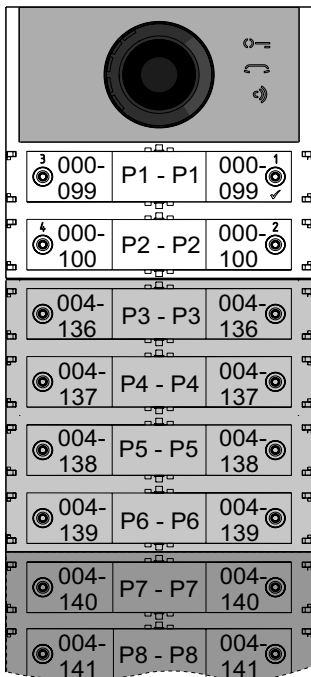
buttons P1 and P2 are already properly programmed by default so no operation is required;

button P3 must be programmed with the first address of the second group (Block 004 Device 136) by entering the following values:

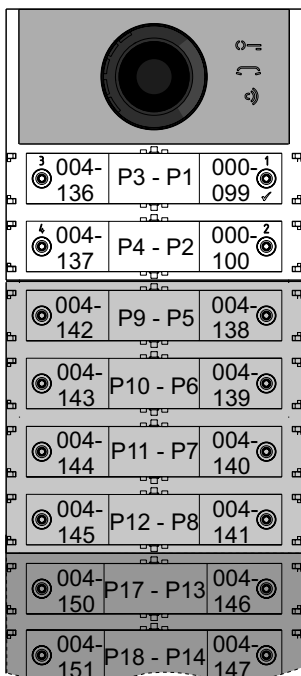
223+P1+004+P3(>4sec.)+224+P1+136+P3(>4 sec.)

after this phase the buttons will call the following addresses:

Single button



Double button

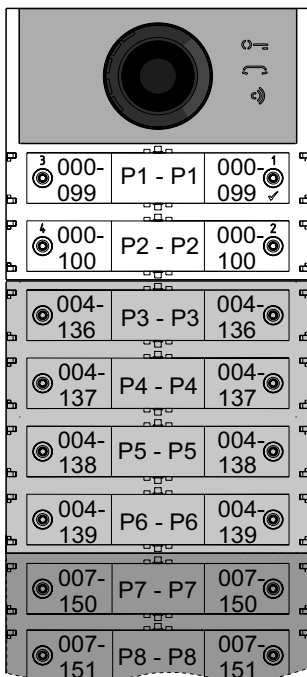


To complete the programming, you must program the button P7 with the first address of the third group (Block 007 Device 150) by entering the following values:

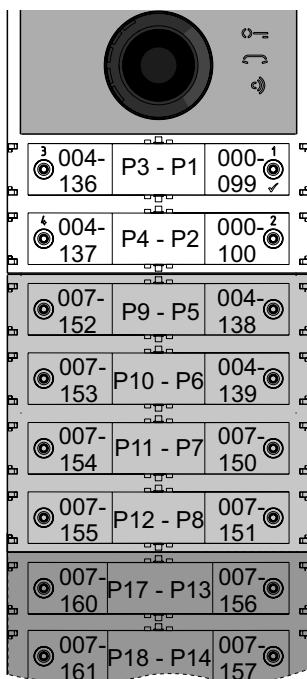
223+P1+007+P7(>4sec.)+224+P1+150+P7(>4 sec.)

after this phase the buttons will call the following addresses:

Single button



Double button



- Continue with the next programming or exit programming.

Video intercom programming

The FARFISA DUO systems and the ALBA series push-buttons panel allow you to quickly and easily program the intercoms or video-intercoms inside the apartments. Simplified programming procedures differ depending on whether they are intercoms or video intercoms with automatic or manual address programming.

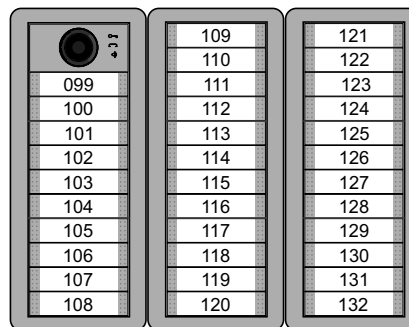
Video intercom systems with automatic address programming

- Arrange the intercom or video-intercom for automatic programming (see the relevant product manual);
- on the door station, press the button to which you want to associate the call;
- on the intercom or video-intercom, exit the automatic programming (see the relevant product manual);
- proceed in the same way for all devices to be programmed.

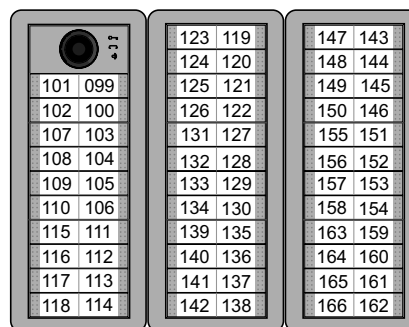
Video intercom system with manual address programming

- Note the address that is called by the door station buttons as shown in the following figures, depending on whether it is a single or double button door station;
- on the intercom or video-intercom, move the micro-switches in order to set the address associated with the call button that is to be assigned to the device (see the relevant product manual);
- proceed in the same way for all devices to be programmed.

Single button



Double button



Special programming: Free tone disabling (323).

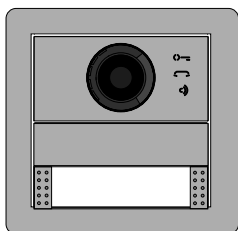
It is possible to enable / disable the free tone generated by the external unit when the call is sent. Once in programming it is necessary:

- Enter code 323;
- press button 1/√ to confirm;
- to **disable** the tone, enter the **value 111**;
- to **enable** the tone, enter the **value 222**;
- press button 1/√ to confirm;
- Continue with the next programming or exit programming.

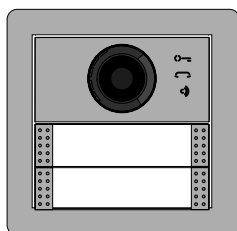


EXAMPLES AND COMPOSITION BOARDS

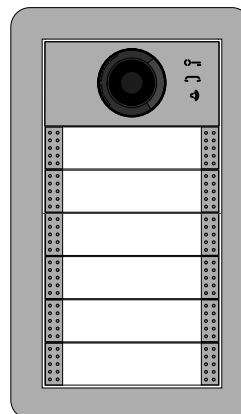
ALBA video door station composition examples.



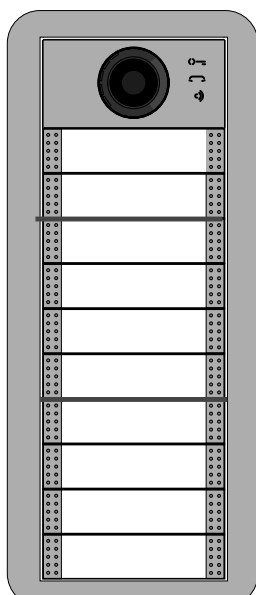
1 call single button  
2 calls double button.



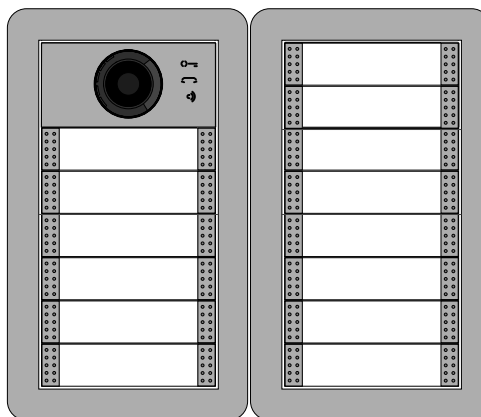
2 calls single button  
4 calls double button.



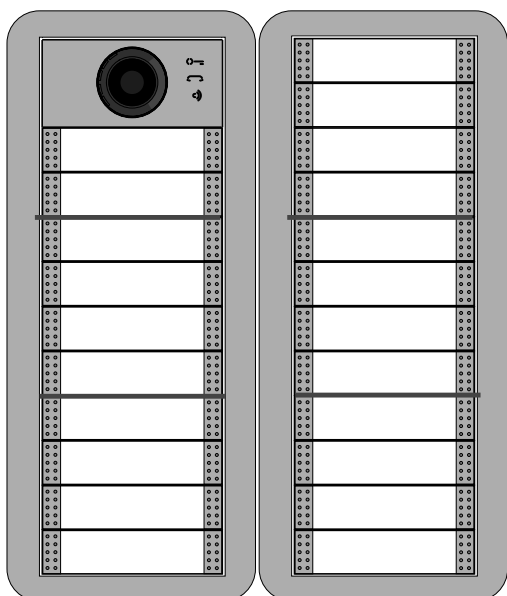
6 calls single button  
12 calls double button.



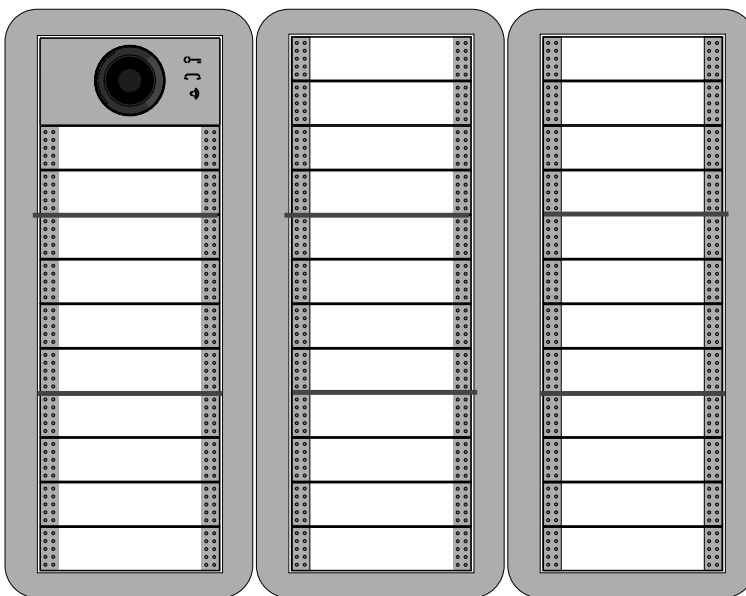
10 calls single button  
20 calls double button.



14 calls single button  
28 calls double button.



22 calls single button  
44 calls double button.



34 calls single button  
68 calls double button.

**Single button built-in ALBA video door station composition board (\*).**

Call N.	Dimensions WxHxD mm	A/V module (**)	Button module	Button	Cover	Blank module (***)	Built-in box	Cable	Module frame	Front frame									
1	124x124x11	CV2124AB	1	AB21	1	AB20	1	SC1	1	AB71	1	AB61	1						
2		CV2124AB	1	AB21	2	AB20	1	SC1	1	AB71	1	AB61	1						
3	124x216x11	CV2124AB	1	CT2138AB	1	AB21	3	AB20	3	SC2	1	AB72	1	AB62	1				
4		CV2124AB	1	CT2138AB	1	AB21	4	AB20	2	SC2	1	AB72	1	AB62	1				
5		CV2124AB	1	CT2138AB	1	AB21	5	AB20	1	SC2	1	AB72	1	AB62	1				
6		CV2124AB	1	CT2138AB	1	AB21	6	AB20	1	SC2	1	AB72	1	AB62	1				
7	124x307x11	CV2124AB	1	CT2138AB	2	AB21	7	AB20	3	SC3	1	AB73	1	AB63	1				
8		CV2124AB	1	CT2138AB	2	AB21	8	AB20	2	SC3	1	AB73	1	AB63	1				
9		CV2124AB	1	CT2138AB	2	AB21	9	AB20	1	SC3	1	AB73	1	AB63	1				
10		CV2124AB	1	CT2138AB	2	AB21	10	AB20	1	SC3	1	AB73	1	AB63	1				
11	248x216x11	CV2124AB	1	CT2138AB	3	AB21	11	AB20	3	SC2	2	EC733	1	AB72	2	AB62	2		
12		CV2124AB	1	CT2138AB	3	AB21	12	AB20	2	SC2	2	EC733	1	AB72	2	AB62	2		
13		CV2124AB	1	CT2138AB	3	AB21	13	AB20	1	SC2	2	EC733	1	AB72	2	AB62	2		
14		CV2124AB	1	CT2138AB	3	AB21	14	AB20	1	SC2	2	EC733	1	AB72	2	AB62	2		
15	248x307x11	CV2124AB	1	CT2138AB	4	AB21	15	AB20	3	AB00	1	SC3	2	EC733	1	AB73	2	AB63	2
16		CV2124AB	1	CT2138AB	4	AB21	16	AB20	2	AB00	1	SC3	2	EC733	1	AB73	2	AB63	2
17		CV2124AB	1	CT2138AB	4	AB21	17	AB20	1	AB00	1	SC3	2	EC733	1	AB73	2	AB63	2
18		CV2124AB	1	CT2138AB	4	AB21	18	AB20	1	AB00	1	SC3	2	EC733	1	AB73	2	AB63	2
19		CV2124AB	1	CT2138AB	5	AB21	19	AB20	3	AB00	1	SC3	2	EC733	1	AB73	2	AB63	2
20		CV2124AB	1	CT2138AB	5	AB21	20	AB20	2	AB00	1	SC3	2	EC733	1	AB73	2	AB63	2
21		CV2124AB	1	CT2138AB	5	AB21	21	AB20	1	AB00	1	SC3	2	EC733	1	AB73	2	AB63	2
22		CV2124AB	1	CT2138AB	5	AB21	22	AB20	1	AB00	1	SC3	2	EC733	1	AB73	2	AB63	2
23	372x307x11	CV2124AB	1	CT2138AB	6	AB21	23	AB20	3	AB00	2	SC3	3	EC733	2	AB73	3	AB63	3
24		CV2124AB	1	CT2138AB	6	AB21	24	AB20	2	AB00	2	SC3	3	EC733	2	AB73	3	AB63	3
25		CV2124AB	1	CT2138AB	6	AB21	25	AB20	1	AB00	2	SC3	3	EC733	2	AB73	3	AB63	3
26		CV2124AB	1	CT2138AB	6	AB21	26	AB20	1	AB00	2	SC3	3	EC733	2	AB73	3	AB63	3
27		CV2124AB	1	CT2138AB	7	AB21	27	AB20	3	AB00	1	SC3	3	EC733	2	AB73	3	AB63	3
28		CV2124AB	1	CT2138AB	7	AB21	28	AB20	2	AB00	1	SC3	3	EC733	2	AB73	3	AB63	3
29		CV2124AB	1	CT2138AB	7	AB21	29	AB20	1	AB00	1	SC3	3	EC733	2	AB73	3	AB63	3
30		CV2124AB	1	CT2138AB	7	AB21	30	AB20	1	AB00	1	SC3	3	EC733	2	AB73	3	AB63	3
31		CV2124AB	1	CT2138AB	8	AB21	31	AB20	3	AB00	1	SC3	3	EC733	2	AB73	3	AB63	3
32		CV2124AB	1	CT2138AB	8	AB21	32	AB20	2	AB00	1	SC3	3	EC733	2	AB73	3	AB63	3
33		CV2124AB	1	CT2138AB	8	AB21	33	AB20	1	AB00	1	SC3	3	EC733	2	AB73	3	AB63	3
34		CV2124AB	1	CT2138AB	8	AB21	34	AB20	1	AB00	1	SC3	3	EC733	2	AB73	3	AB63	3

(\*) By single-button call we mean the programming that associates the same address to both sides of the button AB21, pressing to make the call from the right side and from the left side the user himself rings.

(\*\*) By replacing the CV2124AB audio-video module with the CA2124AB audio-only module, the composition of the audio panel is obtained.

(\*\*\*) Instead of each AB00, you can install the AB50 house number module or the CT2138AB button module with 4 AB20 covers.

# POWERED FROM THE BUS EXTERNAL STATIONS

## Double button built-in ALBA video door station composition board (\*).

Call N.	Dimensions WxHxD mm	A/V module (**)	Button module	Button	Cover	Blank module (***)	Built-in box	Cable	Module frame	Front frame									
2	124x124x11	CV2124AB	1	AB21	1	AB20	1	SC1	1	AB71	1	AB61	1						
4		CV2124AB	1	AB21	2			SC1	1	AB71	1	AB61	1						
6	124x216x11	CV2124AB	1	CT2138AB	1	AB21	3	AB20	3	SC2	1	AB72	1	AB62	1				
8		CV2124AB	1	CT2138AB	1	AB21	4	AB20	2	SC2	1	AB72	1	AB62	1				
10		CV2124AB	1	CT2138AB	1	AB21	5	AB20	1	SC2	1	AB72	1	AB62	1				
12		CV2124AB	1	CT2138AB	1	AB21	6			SC2	1	AB72	1	AB62	1				
14	124x307x11	CV2124AB	1	CT2138AB	2	AB21	7	AB20	3	SC3	1	AB73	1	AB63	1				
16		CV2124AB	1	CT2138AB	2	AB21	8	AB20	2	SC3	1	AB73	1	AB63	1				
18		CV2124AB	1	CT2138AB	2	AB21	9	AB20	1	SC3	1	AB73	1	AB63	1				
20		CV2124AB	1	CT2138AB	2	AB21	10			SC3	1	AB73	1	AB63	1				
22	248x216x11	CV2124AB	1	CT2138AB	3	AB21	11	AB20	3	SC2	2	EC733	1	AB72	2	AB62	2		
24		CV2124AB	1	CT2138AB	3	AB21	12	AB20	2	SC2	2	EC733	1	AB72	2	AB62	2		
26		CV2124AB	1	CT2138AB	3	AB21	13	AB20	1	SC2	2	EC733	1	AB72	2	AB62	2		
28		CV2124AB	1	CT2138AB	3	AB21	14			SC2	2	EC733	1	AB72	2	AB62	2		
30	248x307x11	CV2124AB	1	CT2138AB	4	AB21	15	AB20	3	AB00	1	SC3	2	EC733	1	AB73	2	AB63	2
32		CV2124AB	1	CT2138AB	4	AB21	16	AB20	2	AB00	1	SC3	2	EC733	1	AB73	2	AB63	2
34		CV2124AB	1	CT2138AB	4	AB21	17	AB20	1	AB00	1	SC3	2	EC733	1	AB73	2	AB63	2
36		CV2124AB	1	CT2138AB	4	AB21	18			AB00	1	SC3	2	EC733	1	AB73	2	AB63	2
38		CV2124AB	1	CT2138AB	5	AB21	19	AB20	3			SC3	2	EC733	1	AB73	2	AB63	2
40		CV2124AB	1	CT2138AB	5	AB21	20	AB20	2			SC3	2	EC733	1	AB73	2	AB63	2
42		CV2124AB	1	CT2138AB	5	AB21	21	AB20	1			SC3	2	EC733	1	AB73	2	AB63	2
44		CV2124AB	1	CT2138AB	5	AB21	22					SC3	2	EC733	1	AB73	2	AB63	2
46	372x307x11	CV2124AB	1	CT2138AB	6	AB21	23	AB20	3	AB00	2	SC3	3	EC733	2	AB73	3	AB63	3
48		CV2124AB	1	CT2138AB	6	AB21	24	AB20	2	AB00	2	SC3	3	EC733	2	AB73	3	AB63	3
50		CV2124AB	1	CT2138AB	6	AB21	25	AB20	1	AB00	2	SC3	3	EC733	2	AB73	3	AB63	3
52		CV2124AB	1	CT2138AB	6	AB21	26			AB00	2	SC3	3	EC733	2	AB73	3	AB63	3
54		CV2124AB	1	CT2138AB	7	AB21	27	AB20	3	AB00	1	SC3	3	EC733	2	AB73	3	AB63	3
56		CV2124AB	1	CT2138AB	7	AB21	28	AB20	2	AB00	1	SC3	3	EC733	2	AB73	3	AB63	3
58		CV2124AB	1	CT2138AB	7	AB21	29	AB20	1	AB00	1	SC3	3	EC733	2	AB73	3	AB63	3
60		CV2124AB	1	CT2138AB	7	AB21	30			AB00	1	SC3	3	EC733	2	AB73	3	AB63	3
62		CV2124AB	1	CT2138AB	8	AB21	31	AB20	3			SC3	3	EC733	2	AB73	3	AB63	3
64		CV2124AB	1	CT2138AB	8	AB21	32	AB20	2			SC3	3	EC733	2	AB73	3	AB63	3
66		CV2124AB	1	CT2138AB	8	AB21	33	AB20	1			SC3	3	EC733	2	AB73	3	AB63	3
68		CV2124AB	1	CT2138AB	8	AB21	34					SC3	3	EC733	2	AB73	3	AB63	3

(\*) For a double-button call we mean the programming that associates different addresses to each of the sides of the button AB21, pressing to make the call from the right side rings a different user than what happens by pressing from the left side.

(\*\*) By replacing the CV2124AB audio-video module with the CA2124AB audio-only module, the composition of the audio panel is obtained.

(\*\*\*) Instead of each AB00, you can install the AB50 house number module or the CT2138AB button module with 4 AB20 covers.






3  
A



DUO system



ALBA

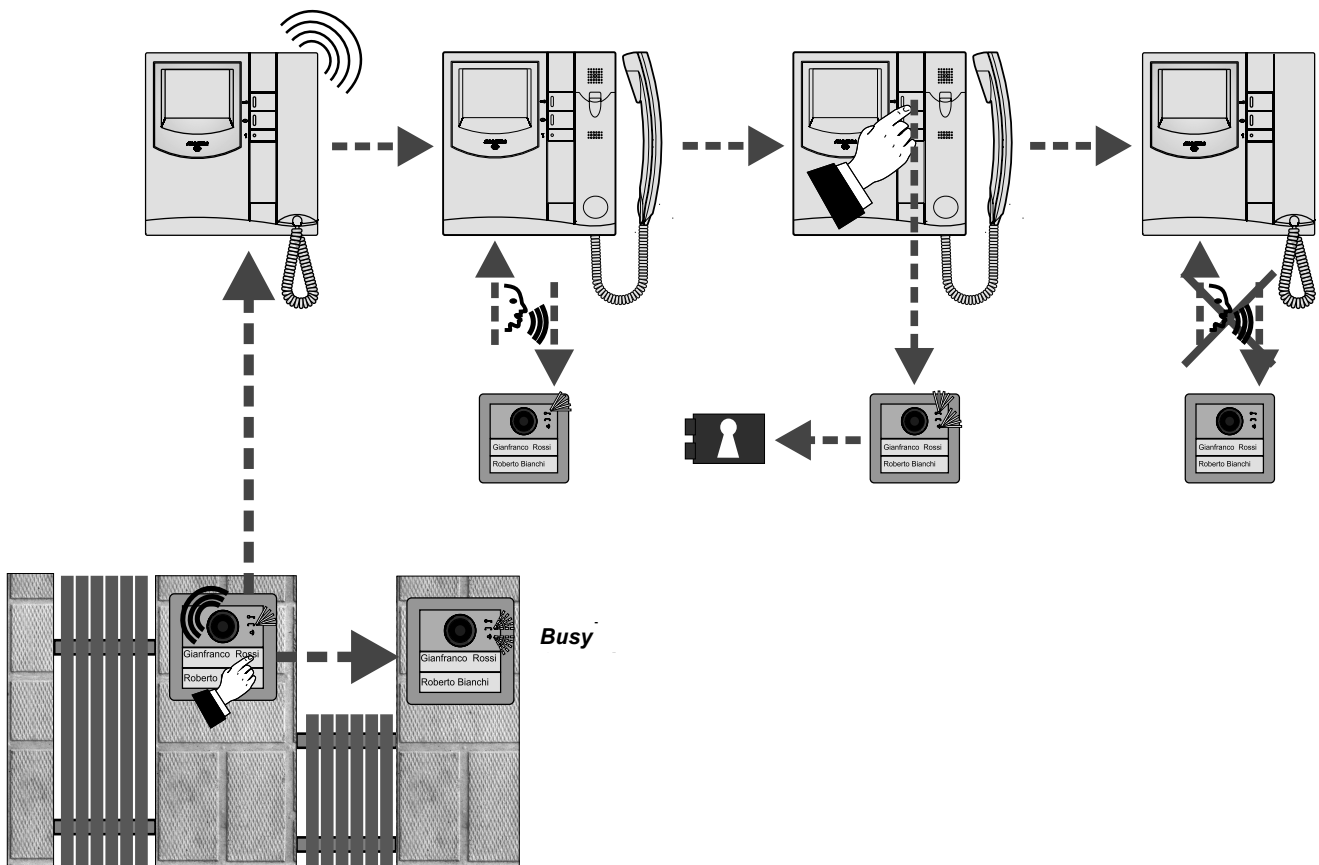
**OPERATION**

**⚠ Attention:** before powering the system, carefully check that the device connections are correct.

To make the call, press the desired user button, if the user is busy or unavailable, the busy tone will sound and the  and , symbols will flash quickly, if the user is free, you will hear the call tone and the  symbol will light up. Other external units in the system will be busy while the device called is ringing and it will have 30 seconds to respond; if at this stage you press the same button again, the call is re-forwarded, and if you press another button the current call will be terminated and the call will be forwarded to the new user. The called user, by lifting the handset, enables the conversation for 90 seconds (8 minutes if specifically programmed - code 128) and the  symbol on the audio-video module will light up. 10 seconds before the end of the conversation, you will hear a tone and the  symbol will start flashing, press the user button called again to continue the conversation for another 90 seconds (or 8 minutes).

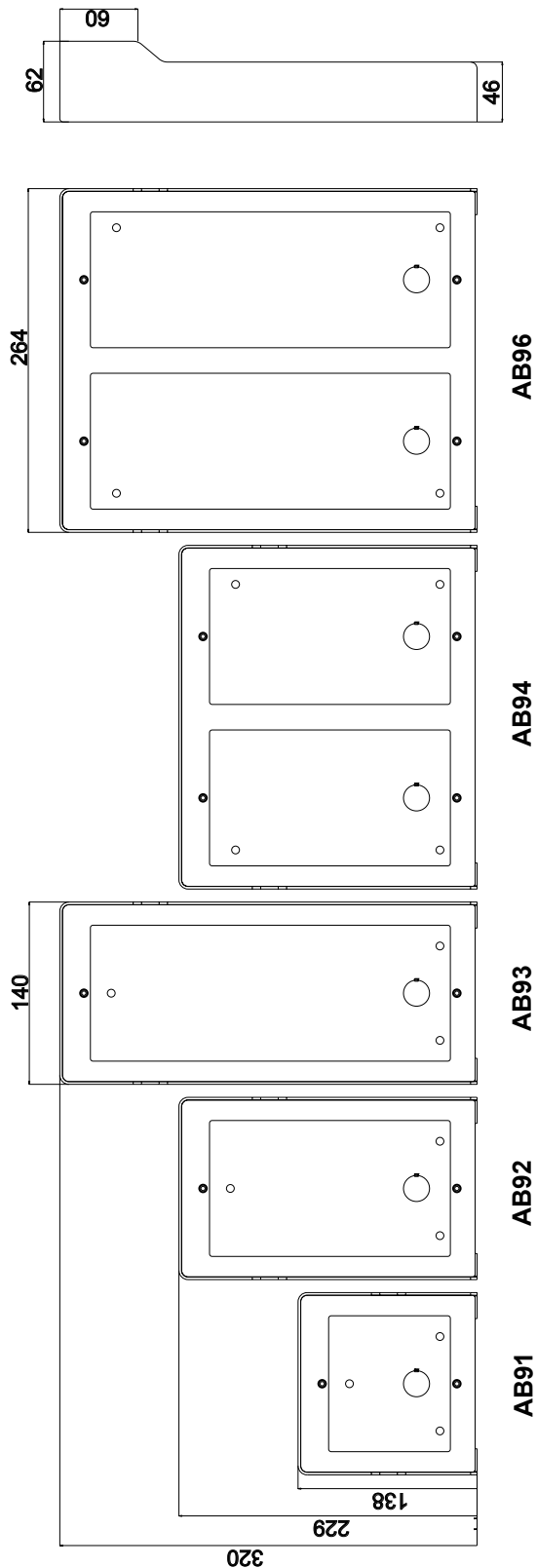
To activate the electric lock from the video intercom, press the  button, the  symbol will light up on the audio-video module; the activation time of the lock is 1 second but can be reprogrammed (code 131). The system returns to standby when the handset is replaced.

**⚠ Attention:** when the  and  symbols on the audio-video module flash simultaneously it means the system is busy, to perform a call wait for both symbols to turn OFF.

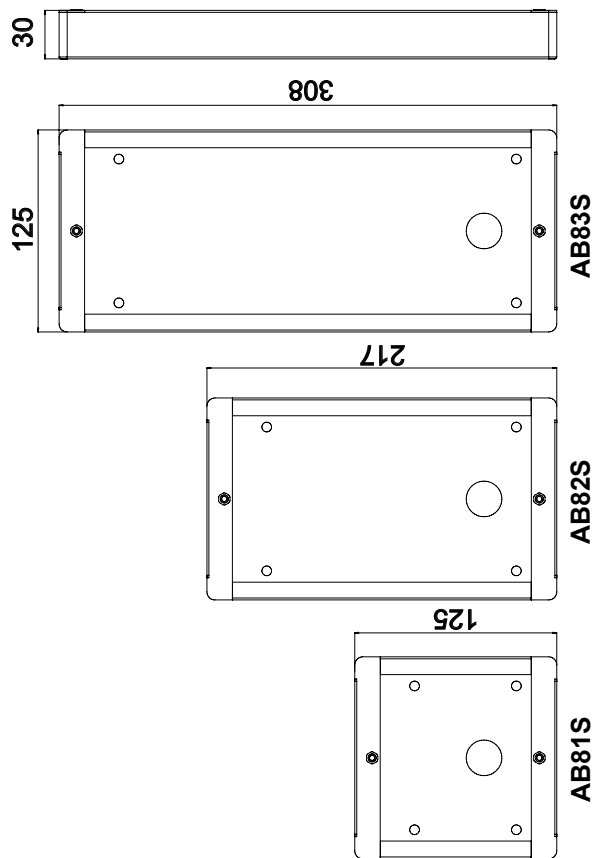


**FLUSH MOUNTED VERSION**

**AB91, AB92, AB93, AB94, AB96.** Rain shelters for surface mounting.



**AB81S, AB82S, AB83S.** Boxes for surface mounting.



**Single button surface mounting ALBA video door station composition board (\*).**

Call N.	Dimensions WxHxD mm	A/V module (**)	Button module	Button	Cover	Blank module (***)	Rain shelter	Cable	Module frame	Front frame									
1	140x138x62	CV2124AB	1	AB21	1	AB20	1		AB91	1	AB71	1	AB61	1					
2		CV2124AB	1	AB21	2				AB91	1	AB71	1	AB61	1					
3	140x229x62	CV2124AB	1	CT2138AB	1	AB21	3	AB20	3		AB92	1	AB72	1	AB62	1			
4		CV2124AB	1	CT2138AB	1	AB21	4	AB20	2		AB92	1	AB72	1	AB62	1			
5		CV2124AB	1	CT2138AB	1	AB21	5	AB20	1		AB92	1	AB72	1	AB62	1			
6		CV2124AB	1	CT2138AB	1	AB21	6			AB92	1	AB72	1	AB62	1				
7	140x320x62	CV2124AB	1	CT2138AB	2	AB21	7	AB20	3		AB93	1	AB73	1	AB63	1			
8		CV2124AB	1	CT2138AB	2	AB21	8	AB20	2		AB93	1	AB73	1	AB63	1			
9		CV2124AB	1	CT2138AB	2	AB21	9	AB20	1		AB93	1	AB73	1	AB63	1			
10		CV2124AB	1	CT2138AB	2	AB21	10			AB93	1	AB73	1	AB63	1				
11	264x229x62	CV2124AB	1	CT2138AB	3	AB21	11	AB20	3		AB94	1	EC733	1	AB72	2	AB62	2	
12		CV2124AB	1	CT2138AB	3	AB21	12	AB20	2		AB94	1	EC733	1	AB72	2	AB62	2	
13		CV2124AB	1	CT2138AB	3	AB21	13	AB20	1		AB94	1	EC733	1	AB72	2	AB62	2	
14		CV2124AB	1	CT2138AB	3	AB21	14			AB94	1	EC733	1	AB72	2	AB62	2		
15	264x320x62	CV2124AB	1	CT2138AB	4	AB21	15	AB20	3	AB00	1	AB96	1	EC733	1	AB73	2	AB63	2
16		CV2124AB	1	CT2138AB	4	AB21	16	AB20	2	AB00	1	AB96	1	EC733	1	AB73	2	AB63	2
17		CV2124AB	1	CT2138AB	4	AB21	17	AB20	1	AB00	1	AB96	1	EC733	1	AB73	2	AB63	2
18		CV2124AB	1	CT2138AB	4	AB21	18			AB00	1	AB96	1	EC733	1	AB73	2	AB63	2
19		CV2124AB	1	CT2138AB	5	AB21	19	AB20	3			AB96	1	EC733	1	AB73	2	AB63	2
20		CV2124AB	1	CT2138AB	5	AB21	20	AB20	2			AB96	1	EC733	1	AB73	2	AB63	2
21		CV2124AB	1	CT2138AB	5	AB21	21	AB20	1			AB96	1	EC733	1	AB73	2	AB63	2
22		CV2124AB	1	CT2138AB	5	AB21	22					AB96	1	EC733	1	AB73	2	AB63	2

**Double button surface mounting ALBA video door station composition board (\*).**

Call N.	Dimensions WxHxD mm	A/V module (**)	Button module	Button	Cover	Blank module (***)	Rain shelter	Cable	Module frame	Front frame									
2	140x138x62	CV2124AB	1	AB21	1	AB20	1		AB91	1	AB71	1	AB61	1					
4		CV2124AB	1	AB21	2				AB91	1	AB71	1	AB61	1					
6	140x229x62	CV2124AB	1	CT2138AB	1	AB21	3	AB20	3		AB92	1	AB72	1	AB62	1			
8		CV2124AB	1	CT2138AB	1	AB21	4	AB20	2		AB92	1	AB72	1	AB62	1			
10		CV2124AB	1	CT2138AB	1	AB21	5	AB20	1		AB92	1	AB72	1	AB62	1			
12		CV2124AB	1	CT2138AB	1	AB21	6			AB92	1	AB72	1	AB62	1				
14	140x320x62	CV2124AB	1	CT2138AB	2	AB21	7	AB20	3		AB93	1	AB73	1	AB63	1			
16		CV2124AB	1	CT2138AB	2	AB21	8	AB20	2		AB93	1	AB73	1	AB63	1			
18		CV2124AB	1	CT2138AB	2	AB21	9	AB20	1		AB93	1	AB73	1	AB63	1			
20		CV2124AB	1	CT2138AB	2	AB21	10			AB93	1	AB73	1	AB63	1				
22	264x229x62	CV2124AB	1	CT2138AB	3	AB21	11	AB20	3		AB94	1	EC733	1	AB72	2	AB62	2	
24		CV2124AB	1	CT2138AB	3	AB21	12	AB20	2		AB94	1	EC733	1	AB72	2	AB62	2	
26		CV2124AB	1	CT2138AB	3	AB21	13	AB20	1		AB94	1	EC733	1	AB72	2	AB62	2	
28		CV2124AB	1	CT2138AB	3	AB21	14			AB94	1	EC733	1	AB72	2	AB62	2		
30	264x320x62	CV2124AB	1	CT2138AB	4	AB21	15	AB20	3	AB00	1	AB96	1	EC733	1	AB73	2	AB63	2
32		CV2124AB	1	CT2138AB	4	AB21	16	AB20	2	AB00	1	AB96	1	EC733	1	AB73	2	AB63	2
34		CV2124AB	1	CT2138AB	4	AB21	17	AB20	1	AB00	1	AB96	1	EC733	1	AB73	2	AB63	2
36		CV2124AB	1	CT2138AB	4	AB21	18			AB00	1	AB96	1	EC733	1	AB73	2	AB63	2
38		CV2124AB	1	CT2138AB	5	AB21	19	AB20	3			AB96	1	EC733	1	AB73	2	AB63	2
40		CV2124AB	1	CT2138AB	5	AB21	20	AB20	2			AB96	1	EC733	1	AB73	2	AB63	2
42		CV2124AB	1	CT2138AB	5	AB21	21	AB20	1			AB96	1	EC733	1	AB73	2	AB63	2
44		CV2124AB	1	CT2138AB	5	AB21	22					AB96	1	EC733	1	AB73	2	AB63	2

(\*). By single or double button call we mean the programming that associates the same address to both sides of the button or different addresses to each of the two sides of the AB21, pressing to make the call from the right side or from the left side rings the same user or different users.

(\*\*). By replacing the CV2124AB audio-video module with the CA2124AB audio-only module, the composition of the audio panel is obtained.

(\*\*\*). Instead of each AB00, you can install the AB50 house number module or the CT2138AB button module with 4 AB20 covers.

## Chapter 4

# POWER SUPPLIES and SERVICE MODULES

	<i>Page</i>
<b>POWERSUPPLIES</b> _____	<b>4.2</b>
- Transformers	4.2
- Line power supplies	4.2
<b>SERVICE MODULES</b> _____	<b>4.3</b>
- Video amplifier 2223Q	4.3
- Video distributors	4.6
- Line distributor	4.6
- Line distributor - exchanger DV2422A	4.7
- <i>Programming</i>	4.7
- Line buffer 2231Q	4.9
- <i>Programming</i>	4.10
- Line distributor DM2421	4.11
- <i>Programming</i>	4.11
- <i>Operation</i>	4.12
- 4 inputs and 4 outputs line distributor DM2444	4.13
- <i>Programming</i>	4.13
- Video modulator VM2521	4.18
- <i>Programming</i>	4.19
- <i>Operation</i>	4.19
- 4 or 7-exchanger selector 2287	4.21
- <i>Programming</i>	4.21
- <i>Operation</i>	4.23
- Doorkeeper exchanger PDX2000	4.25
- <i>Characteristics</i>	4.26
- <i>Installation</i>	4.27
- <i>Programming</i>	4.30
- <i>Operation</i>	4.31
- Actuator module 2281Q	4.36
- <i>Installation</i>	4.36
- <i>Operation</i>	4.37
- <i>Programming</i>	4.38
- Encoding board XT2928U	4.41
- <i>Installation</i>	4.41
- <i>Programming</i>	4.41

The power supplies and transformers are protected against overloading or short-circuiting by a heat sensor (thermoprotector), to restore power, it is necessary to cut off the mains voltage for about one minute. Reconnect power after having repaired the fault.

Do not obstruct the openings or the ventilation or heat ejection slots to allow the equipment to operate correctly.

The power supply can be installed on DIN rail or screwed to the wall.

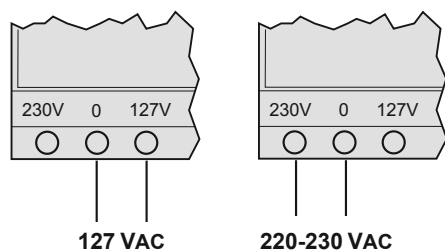
Each transformer **2220S** can power a maximum of **6 modules of the external door station** (modules: audio/video, audio only, digital keyboard, digital encoder, buttons, etc...).

Add a transformer **PRS210** for a higher number of modules.

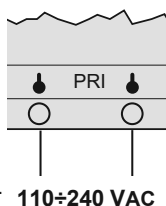
### Input terminals for electrical mains

All power supplies and transformers (except the art.2221S) in this manual can work either 127Vac or 220-230Vac.

**Check carefully the right connection.**



Unlike all other power supplies and transformers, art. **2221S** only has 2 input terminals for connection to the electrical mains (terminals **PRI**). Voltage from 110V to 240V can be applied to the two terminals.



## TRANSFORMERS

**2220S.** Transformer that can be used to power the door station for DUO system and electric door locks connected to it.

### Technical data

Mains voltage: 127 or 220-230Vac  
 Frequency: 50/60Hz  
 Power: 22VA  
 Output voltage: 13Vac±1  
 Maximum load: 1A  
 Output protection: PTC  
 Approved by: according to the Safety Standard EN60065  
 Housing: DIN 3 modules A  
 Operating temperature: 0°+40°C  
 Maximum permissible humidity: 90%RH  
 Can be fixed on DIN bar or screwed to the wall with 2 expansion plugs

### Output terminals

~ ~ AC voltage output (13Vac)

**PRS 210.** Transformer used to power other 13Vac devices (for example: 2273 exchanger, additional locks, name-plate LEDs, etc...).

### Technical data

Mains voltage: 127 or 220-230Vac  
 Frequency: 50/60Hz  
 Power: 15VA  
 Output voltage: 13Vac±1  
 Maximum load: 0.7A  
 Maximum of intermittent load: 1A  
 Housing: DIN 3 modules A  
 Approved by: VDE according to the Safety Standard EN60065  
 Operating temperature: 0°+40°C  
 Maximum permissible humidity: 90%RH  
 Can be fixed on DIN bar or screwed to the wall with 2 expansion plugs

### Terminals

~ ~ AC voltage output (13Vac)

## LINE POWER SUPPLIES

**2221S.** Device to power up to 50 videointercoms with a proper audio, video and data impedance for the correct operation of the DUO system. It replaces art. 2221 and 2222 in all DUO installations.

### Technical data

Mains voltage: 110V÷240Vac  
 Frequency: 50 ÷ 60 Hz  
 Power: 60VA  
 Maximum load: 0.6A  
 Maximum of intermittent load: 1A  
 Output protection: PTC  
 Approved by: according to the Safety Standard EN60065  
 Housing: DIN 6 modules A  
 Operating temperature: 0°+50°C  
 Maximum permissible humidity: 90%RH  
 Can be fixed on DIN bar or screwed to the wall with 2 expansion plugs

### Terminals

**PRI** Mains voltage input  
**LP/LP** Line output

**2221MQ.** The power supply can power all devices with a proper audio, video and data impedance for the correct operation of the DUO home automation system.

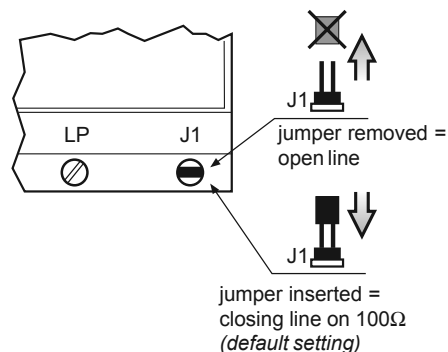
### Technical data

Mains voltage: **(0 / 127)** 127Vac  
**(0 / 230)** 220-230Vac  
 Frequency: 50 ÷ 60 Hz  
 Power: 60VA  
 Maximum load: 0.5A  
 Output protection: PTC  
 Approved by: according to the Safety Standard EN60065  
 Operating temperature: 0° +40°C  
 Maximum admissible humidity: 90% RH  
 Housing: DIN 8 moduli A  
 Can be fixed on DIN bar or screwed to the wall with 2 expansion plugs

### Output terminals

**LP/LP** Line output

**J1 = Jumper for closer or open line for 2221S and 2221MQ power supplies**





## VIDEO AMPLIFIER

**2223Q.** It is used to amplify and regenerate the video signal to increase the installation distance. It can be powered from DUO line or locally.

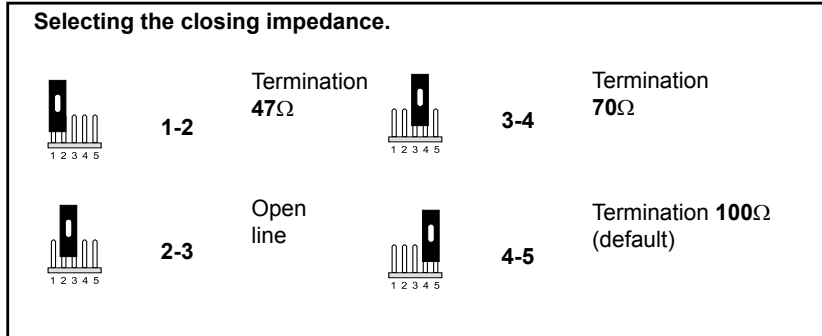
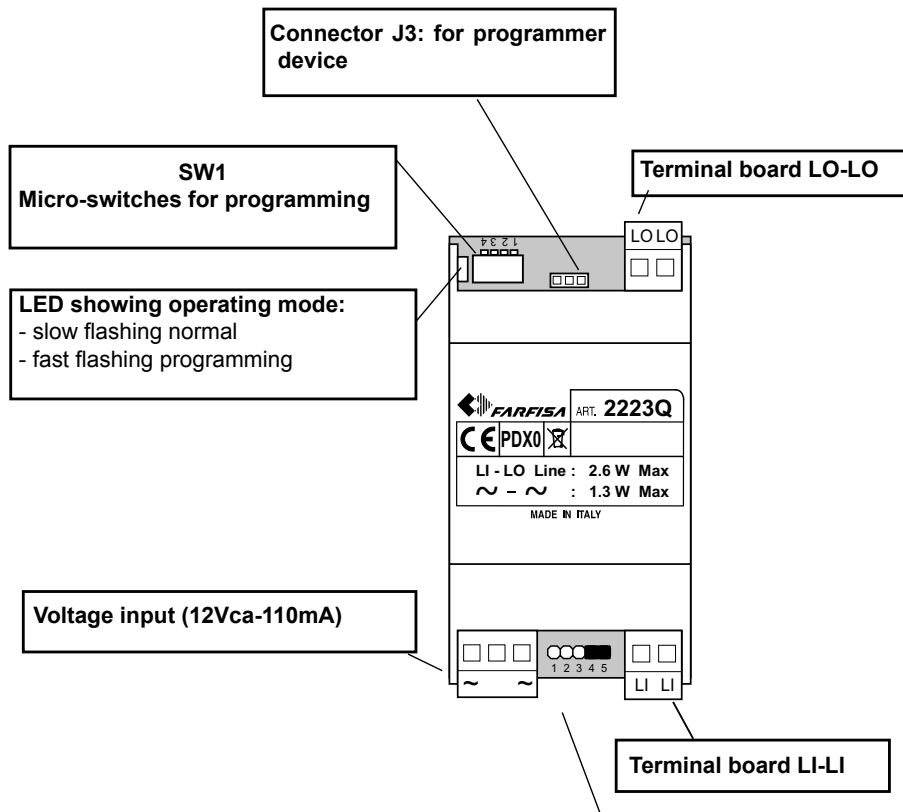
### Technical data

Power supply: - from DUO line  
 - via transformer 13Vca ± 10%  
 Current consumption: - in standby 6mA  
 - in operation 110mA  
 Operating temperature: 0°+50°C  
 Maximum permissible humidity: 90%RH  
 Housing: DIN 3 modules A

### Terminals

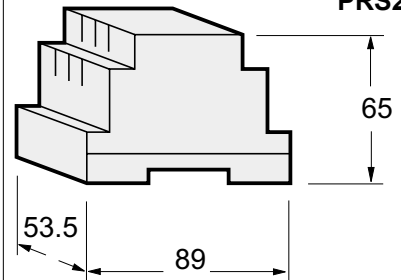
~ AC voltage input  
 LI/LI Line input  
 LO/LO Amplified line output

### Position of connectors and jumpers.

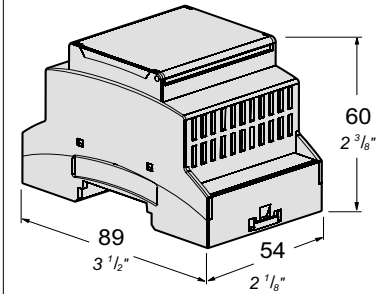


## DIMENSIONS OF DIN MODULES

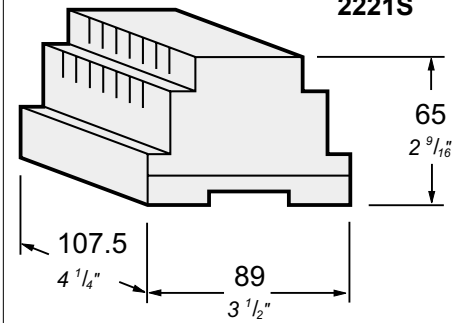
**DIN 3 modules A** *Articles*  
2220S  
PRS210



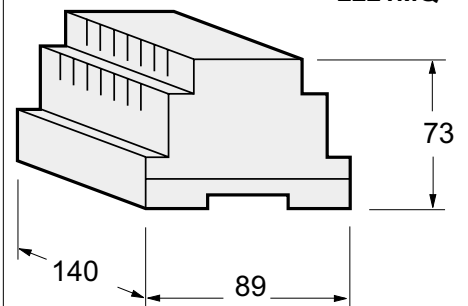
**DIN 3 modules A** 2223Q



**DIN 6 modules A** 2221S



**DIN 8 modules A** 2221MQ



## INSTALLATION

The video amplifier should be connected along a DUO line and it restores the video signal. The device is powered by the line unless a voltage of  $12V_{ca\pm 10\%}$ , it is present to its terminals ~ ~, in this case the device automatically gets power from the local power supply (see installation examples in the following pages). The amplifier doesn't require any programming, but in installations with more risers or if some video instability should occur, it would be advisable to store in the device the addresses of the door stations connected to its LI line and those of the videointercoms connected to its LO line (see PROGRAMMING paragraph.)

## PROGRAMMING

### Preliminary notes

- To manage the addresses of the door stations connected to the line LI the numerical intervals F1÷F5 are available; to manage the addresses of the videointercoms connected to the line LO the numerical intervals F6÷F10 are available. In each numerical interval can be stored the address of a single device or the first and the last address of a group of devices with sequential addresses, connected to the same line.

For example if in the numerical interval F1 is stored only the address 231, on the line LO will be coupled the video signal coming only from the door station 231; if in the same numerical interval F1 are stored the addresses 231 and 234, on the LO line will be coupled the video signal coming from all the door stations whose address is among 231 and 234. In the same way if in the numerical interval F6 is stored only the address 100, on the line LO will be coupled the video signal only for the calls addressed to the videointercom 100; if in the same numerical interval F6 are stored the addresses 100 and 120, on the LO line will be coupled the video signal for all the calls addressed to the videointercoms whose addresses are among 100 and 120.




### Attention:

- in the numerical intervals F1÷F5 must be stored only the addresses of door stations connected to the LI line and not those of the eventual videointercoms connected to the same line; in the numerical intervals F6÷F10 must be stored only the addresses of the videointercoms connected to the LO line and not those of the eventual door stations connected to the same line.
- if during the programming some errors are made or if later it is necessary to modify some addresses already stored in the memory of the device, it is necessary to erase the whole memory of the device executing the "memory erasing" procedure and then reprogramming completely the device.

### Programming the numerical intervals

To program the numerical intervals F1÷F10 it is necessary:

- 1) select the numerical interval to be programmed, positioning the micro switches of SW1 according to the instructions provided in table 1 on next page; red LED flashes quickly.
- 2) Store the address of the devices by following the procedure described here below:
  - to store the address of a door station, make a call from it to any videointercom;
  - to store the address of a videointercom from Zhero and myLogic videointercoms, press the button  from Exhito, press the button



### Notes.

- Correct storage is indicated by the LED which turns OFF for one second and then turns back ON in flashing mode.

If in the numerical interval it is requested to program a group of addresses and then it is requested to program the last address of the group, proceed with the point 3); if, instead, it is requested to program only one address go to point 4).

- 3) From the door station (numerical interval F1÷F5) or from the videointercom (numerical interval F6÷F10) having the higher address, execute the storing procedure as indicated on point 2); the amplifier acquires the address of the last door station or videointercoms belonging to the group.
- 4) If required, proceed in a similar way to program the other 9 numerical intervals repeating the instructions reported on points from 1) to 4) and paying attention to set properly the microswitches of SW1 according to the numerical interval to be programmed (see table 1 on next page).
- 5) To exit the programming mode, set OFF all the microswitches of SW1; red LED comes back flashing slowly.
- 6) Verify the correct operations of door stations and of videointercoms connected to LI and LO lines of the art.2223Q.

### Memory erasing

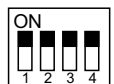
To erase all the data stored in the memory of the device it is necessary:

- set ON microswitches 1,2 and 4 and leave OFF the microswitch 3 of SW1; red LED flashes quickly;



- wait for about 4 seconds; red LED lights up continuously;

- within 4 seconds set ON the microswitch 3; red LED turns OFF for about 2 seconds and then starts again flashing quickly;



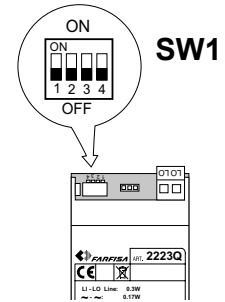
- at this stage all data have been erased;

- set OFF all the SW1 microswitches; red LED comes back flashing slowly.



### Automatic programming (code 15)

See page 4.19.

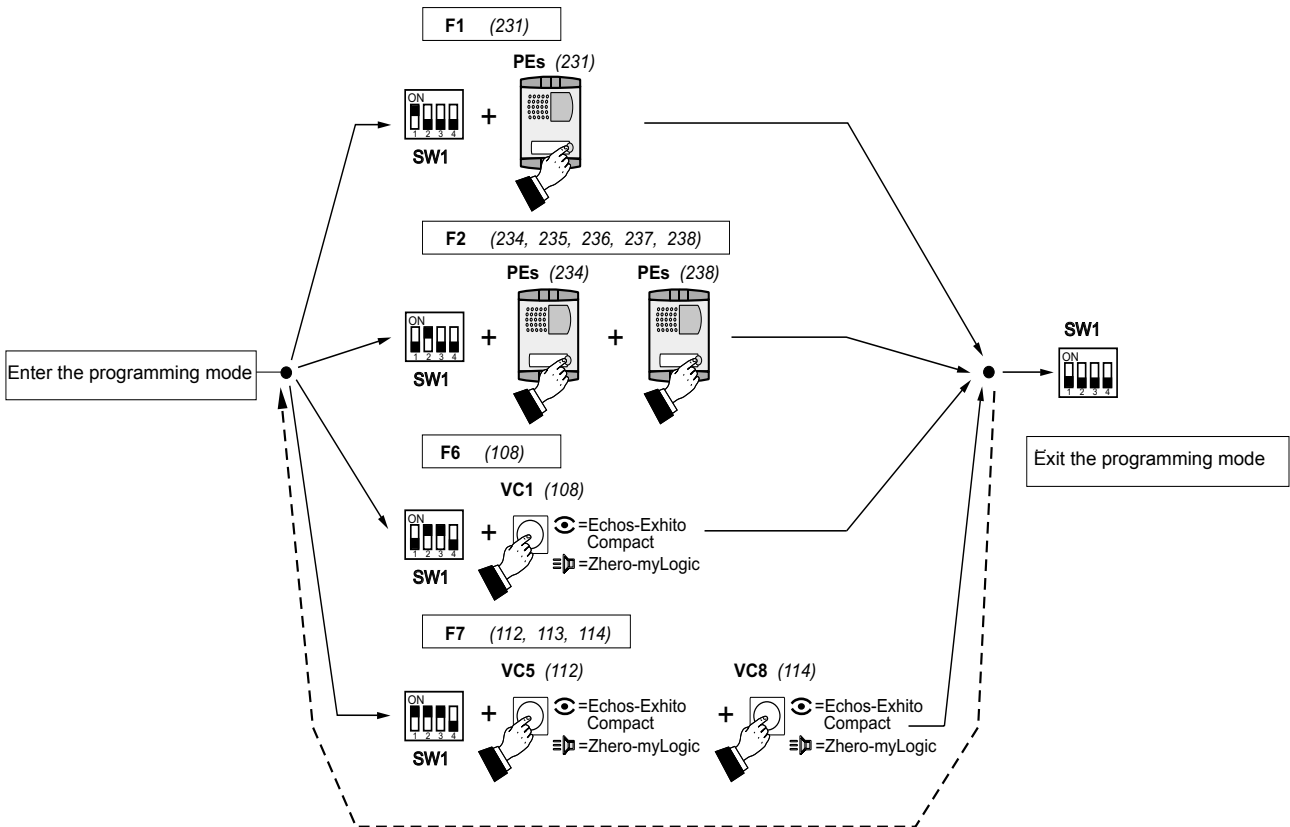


**Table 1 - Position of SW1's microswitches and related numerical intervals.**

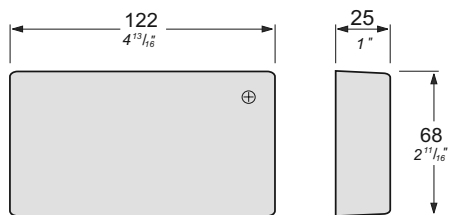
Numerical interval	LI					LO				
	External stations					Videointercoms				
	F1	F2	F3	F4	F5	F6	F7	F8	F9	F10
Position of SW1's microswitches										

**Example of programming 4 numerical intervals:**

F1=F2 (door stations connected to the LI line) and F6=F7 (videointercoms connected to the LO line) for the amplifier art.2223Q. In the example, the amplifier couples on the LO line the video signal coming from the door stations 231, 234, 235, 236, 237 and 238 connected to its LI line and activate, on the LO line, the video signal only for calls addressed to videointercoms 108, 112, 113 and 114.



## VIDEO DISTRIBUTORS WITH 4 OUTPUTS DERIVED



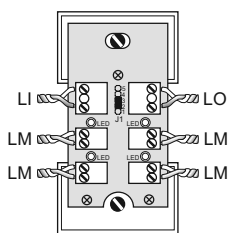
**DV2424Q. Active line distributor** Allows the riser signal line to be distributed to 4 derived lines with **Zhero series** internal stations and the **EX3252 videointercom**. It is with terminal (J1) that let you adjust the line impedance according to the installation requirements. For each derived output there is a red led which, when ON, indicates that transmission of the video signal is enabled.

### Technical features

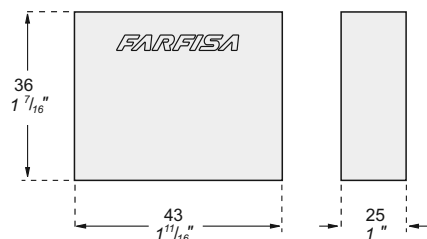
Power supply directly from the line  
 Stand-by current: 8mA  
 Operating current: 40mA  
 Operating temperature: 0° ÷ +50°C  
 Maximum humidity acceptable: 90% RH

### Terminals

**LM-LM** User outputs  
**LI - LI** Line input  
**LO-LO** Line output



## VIDEO DISTRIBUTORS WITH 1 OUTPUT DERIVED



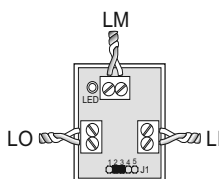
**DV2421Q. Active line distributor** Allows the riser signal line to be distributed to derived line with **Zhero series** internal stations and the **EX3252 video intercom**. It is with terminal (J1) that let you adjust the line impedance according to the installation requirements. When the red led is ON, indicates that passage of the video signal is enabled.

### Technical features

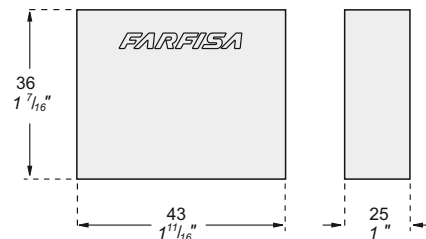
Power supply directly from the line  
 Stand-by current: 8mA  
 Operating current: 40mA  
 Operating temperature: 0° ÷ +50°C  
 Maximum humidity acceptable: 90% RH

### Terminals

**LM-LM** User outputs  
**LI - LI** Line input  
**LO-LO** Line output



## LINE DISTRIBUTOR



**DV2420.** It allows to distribute the line signal from the riser to power supplies and/or actuators. It is with terminal (J1) that let you adjust the line impedance according to the installation requirements.

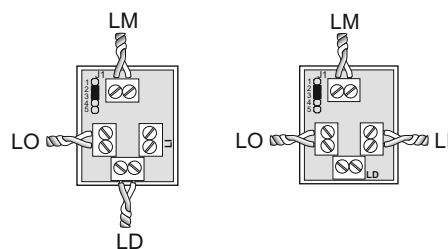
### Technical features

Power supply directly from the line  
 Stand-by current: 8mA  
 Operating current: 40mA  
 Operating temperature: 0° ÷ +50°C  
 Maximum humidity acceptable: 90% RH

### Terminals

**LM/LM** Input/output voltage, data and audio  
**LI/LI** Line input  
**LO/LO** Line output  
**LD/LD** Input/output decoupled line

### Connection types



## Selecting the closing impedance

The line distributors **DV2420**, **DV2421Q**, **DV2422A** and **DV2424Q** are provided with the jumper **J1** that, when placed in the correct position, allows to readapt the signal from the riser for the correct operation of the connected devices.



**1 - 2**  
 termination  
**47Ω**



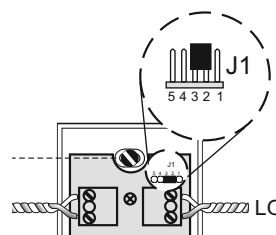
**2 - 3**  
 open line  
 (default)



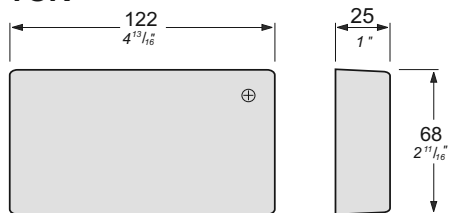
**3 - 4**  
 termination  
**70Ω**



**4 - 5**  
 termination  
**100Ω**



**ACTIVE VIDEO LINE DISTRIBUTOR**



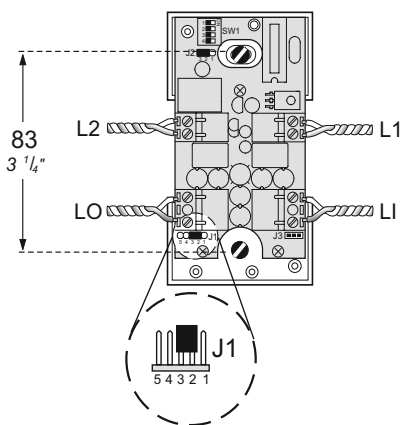
**DV2422A.** In DUO digital systems the line distributor DV2422A delivers the video signal, after a call, only to those videointercoms connected to the line L1 and L2 whose address has been previously programmed as belonging to them; audio and call signals, on the contrary, are delivered to all the devices connected to the lines L1 and L2 without considering their address. The LED, present in the device, turns on the switching and for all the time of activation of the DUO system. The jumper J1 is used to adapt the line impedance to the needs of the installation.

**Technical features**

- Power supply directly from the Stand-by current: 8mA
- Operating current: 40mA
- Operating temperature: 0° ÷ +50°C
- Maximum humidity acceptable: 90% RH

**Terminals**

- LI - LI** Line input
- L1 - L1** Output shunted line 1
- L2 - L2** Output shunted line 2
- LO - LO** Line output



**PROGRAMMING**

**Preliminary notes**

- If in the installation it is present the line buffer art.2230 it is mandatory to program it before programming the line distributor DV2422A.
- To manage videointercom addresses connected to the lines L1 and L2 are available 5 numerical intervals (F1÷F5) for each line (L1-L2). In each numerical interval can be stored the address of a single device or the first and the last address of a group of videointercoms, with sequential addresses, related to the same line. For example if in the numerical interval F1 of the line L1 is stored the address 100, on the line L1 only the video

signal of the calls addressed to the videointercom 100 is delivered. Vice-versa if on the same numerical interval F1 are stored the addresses 100 and 120, on the line L1 are delivered the video signal of the call addressed to all the videointercoms whose address is between 100 and 120.

- Audio Intercoms connected to the line L1 and L2 do not require any programming of the line distributor DV2422A.
- **Attention:** if during the programming some error are made or if later it is necessary to **modify some addresses already stored in the memory** of the line distributor DV2422A, it is necessary to **erase the whole memory of the device** executing the "memory erasing" procedure and than reprogramming completely the device.

**Entering the programming mode**

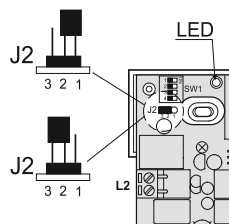
- Move the **jumper J2** from the position 1-2 to 2-3; the red LED flashes quickly.

**Exiting the programming mode**

- Move the **jumper J2** from the position 2-3 to 1-2; the red LED come back to flashing slowly (every 2 seconds). You should set OFF also all microswitches SW1.

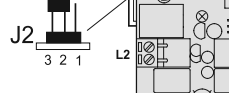
**Programming mode**

2-3 position  
(Red LED flashes quickly)



**Operating mode**

1-2 position  
(Red LED flashes slowly)

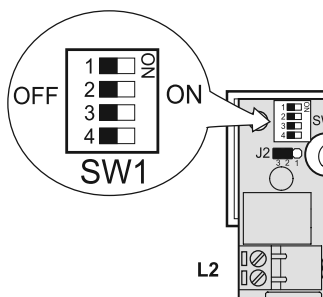


**Programming the numerical intervals**

To program the numerical intervals F1÷F5 it is necessary:

- 1) enter the programming mode moving the **jumper J2** from position 1-2 to 2-3; the red LED flashes quickly
- 2) program the address of the videointercom to assign to the **first numerical interval F1** of **L1** line or the address of the first videointercom belonging to the group of devices which belongs to the numerical interval F1. To make this operation it is necessary:

- set **ON** the **microswitch 1** of **SW1** leaving OFF micro-switches 2, 3 and 4 (see table 4.1)



**Table 4.1**

**Position of SW1's microswitches and related programming function**

Position of SW1's microswitches	Programming function
	numerical interval <b>F1</b> of the line <b>L1</b>
	numerical interval <b>F2</b> of the line <b>L1</b>
	numerical interval <b>F3</b> of the line <b>L1</b>
	numerical interval <b>F4</b> of the line <b>L1</b>
	numerical interval <b>F1</b> of the line <b>L2</b>
	numerical interval <b>F2</b> of the line <b>L2</b>
	numerical interval <b>F3</b> of the line <b>L2</b>
	numerical interval <b>F4</b> of the line <b>L2</b>
	numerical interval <b>F5</b> of the line <b>L2</b>
	memory erasing

- on the videointercom connected to the **L1** line whose address should be stored in the **numerical interval F1**, or on the videointercom whose address should be stored as the first address in the numerical interval F1 press the button (on the videointercoms series **myLogic** and **Zhero**) or the button (on the videointercoms series **Exhito**); videointercom turns ON without any image on the display and the LED of the line distributor turns OFF for about a second and than starts flashing again quickly. Line distributor have stored correctly the address of the first videointercom.
- 3) If to the **numerical interval F1** belongs only the videointercom programmed above, move to the point 4), if not, it is necessary to program the address of the last videointercom belonging to the group. To execute this operation it is necessary:
  - on the videointercom connected to the **L1** line whose address should be stored as the last address in the **numerical interval F1**, press the button (on the videointercoms series **myLogic** and **Zhero**) or the button (on the videointercoms series **Exhito**); videointercom turns ON without any image on the display and the LED of the line distributor turns OFF for about a second and than starts flashing again quickly. Line distributor have stored correctly the address of the last videointercom belonging to the group;

- 4) set **OFF** the microswitch 1 of **SW1**. This operation ends the programming phase of the numerical interval **F1** of line **L1**
- 5) if required proceed in a similar way to program numerical intervals **F2, F3, F4** and **F5** of line **L1** repeating the instructions reported on points 2) and 3) and paying attention to set properly the microswitches of **SW1** according to the numerical interval to be programmed (see table 4.1)
- 6) if required proceed in a similar way to program numerical intervals **F1, F2, F3, F4** and **F5** of line **L2** repeating the instructions reported on points 2) and 3) and paying attention to set properly the microswitches of **SW1** according to the numerical interval to be programmed (see table 4.1)
- 7) set **OFF** all the microswitches of **SW1** and exit the programming mode moving jumper **J2** from position **2-3** to **1-2**; red LED comes back flashing slowly
- 8) verify the correct operations of videointercoms connected to lines **L1** and **L2**.

### Programming for exchanger operation

The **DV2422A distributor**, to be able to switch the video signal from the main line or from the secondary line, must be programmed to function as an **exchanger**; to perform this operation, proceed as follows:

- access programming by moving the jumper **J2** from the position **1-2** to **2-3**; the red LED flashes quickly;
- program the numeric intervals assigned to the **L2** line as shown in the product instruction manual (insert the same address assigned to the secondary external station - e.g.: address 235);

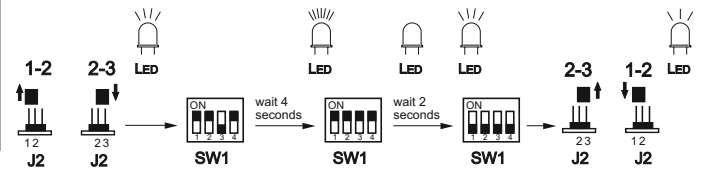
- move the jumper **J2** from the position **2-3** to **1-2** to exit the programming; the led returns to blinking slowly;
- move micro-switch **1** of **SW1** to the **ON** position; the micro-switches **2, 3** and **4** must remain in the **OFF** position;
- with the last operation the device is programmed as an exchanger and the led starts double blinking.

This programming is available from **version 400 or higher** of the DV2422A distributor.

### Memory erasing

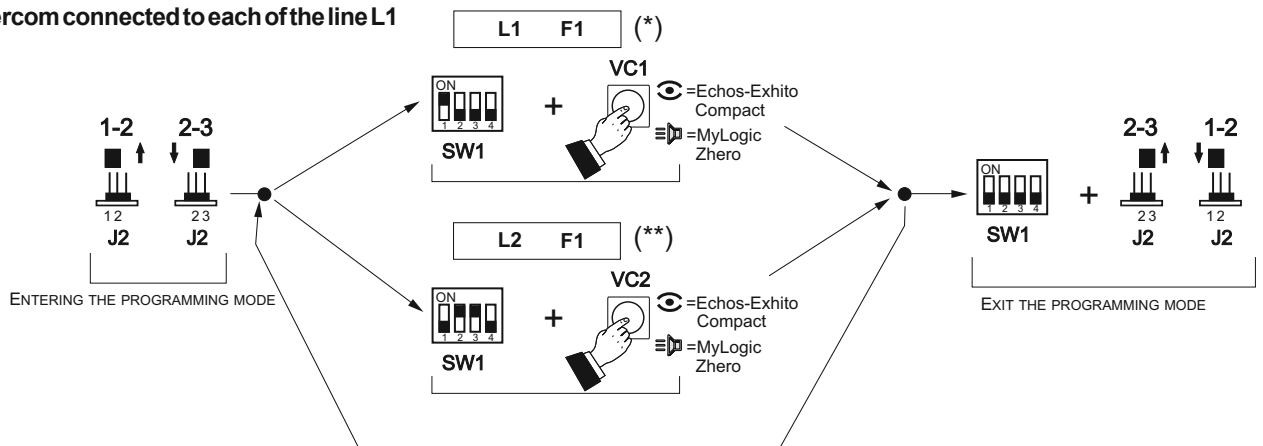
To erase all the data stored in the memory of the device it is necessary:

- move the jumper **J2** from position **1-2** to **2-3**; red LED starts flashing quickly;
- set **ON** the microswitches **1, 2** and **4** of **SW1** (see table 4.1);
- wait for about 4 seconds; red LED lights up continuously
- within 4 sec. set **ON** the microswitch **3**; red LED turns OFF for about 2 sec. and then starts again flashing quickly
- at this stage all the data have been erased
- set **OFF** all the SW1 microswitches
- move the jumper **J2** from position **2-3** to **1-2**; the led returns to blinking slowly.



### Examples of programming

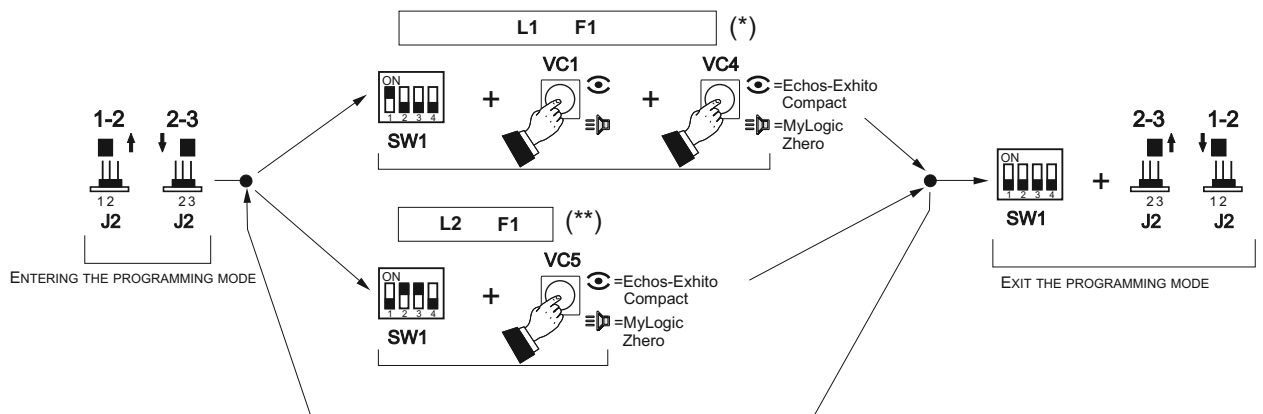
#### 1 videointercom connected to each of the line L1 and L2



(\*) On the line **L1** (numerical interval **F1**) video signal is delivered to **VC1** videointercom.

(\*\*) On the line **L2** (numerical interval **F1**) video signal is delivered to **VC2** videointercom.

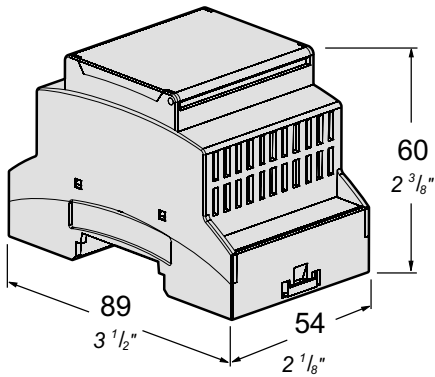
#### 4 videointercoms, with sequential addresses, connected to L1 line and 1 videointercom connected to line L2



(\*) On the line **L1** (numerical interval **F1**) video signal is delivered to **VC1, VC2, VC3** and **VC4** videointercoms with sequential addresses.

(\*\*) On the line **L2** (numerical interval **F1**) video signal is delivered to **VC5** videointercom.

**LINE BUFFER**



**2231Q.** The buffer 2231Q can be used to create independent sections within the same DUO videointercom installation, thus allowing to have local services without engaging the main common line. This device can also be used to divide the system into blocks (DUO Extended Range version PDX2 which allows to manage up to 19800 users and to manage door keeper exchangers either main or secondary).

A few examples are:

- intercom and/or home automation services in one or more apartments with/without a secondary entrance;
- connection of a building (with/without secondary entrance) to one or more main entrances;
- division of the system into blocks (DUO Extended Range) for the connection of several buildings with/without main or secondary entrances and with/without main or secondary door keeper exchangers.

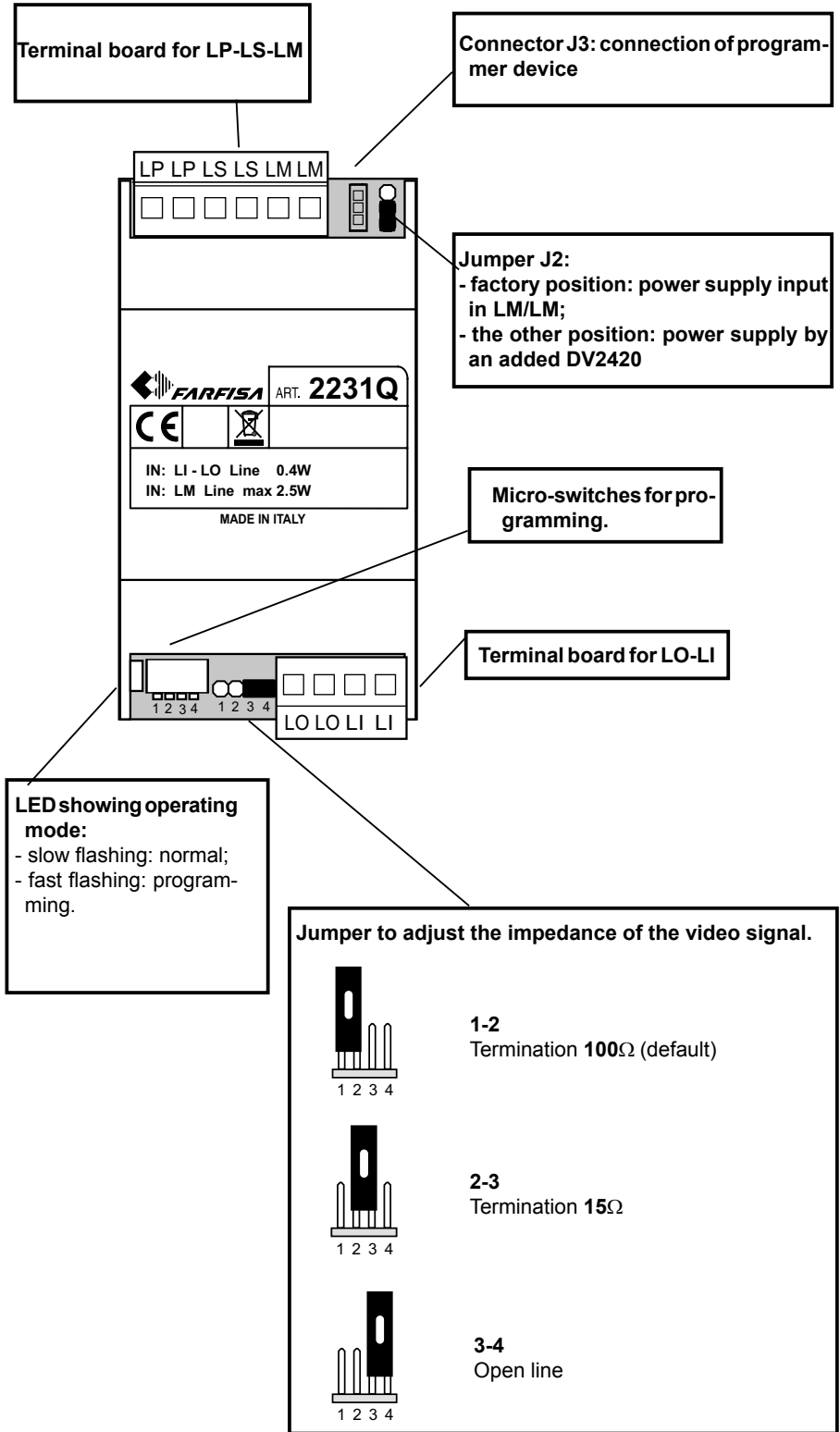
**Technical features**

Power supply from the line  
 Current (LI-LO): 10mA  
 Current (LM-LM): - stand-by 40mA  
                           - operating 70mA  
 Housing: 3 module A DIN  
 Operating temperature: 0° ÷ +50°C  
 Maximum humidity acceptable: 90% RH  
 Fits on DIN bar or with 2 expansion plugs

**Terminals**

- LM - LM** Line power supply input
- LI - LI** Main DUO line input
- LO - LO** Main DUO line output
- LP - LP** Input from secondary door station
- LS - LS** Secondary DUO line output

**Position of connectors and jumpers and related function.**



**Table 1 - Position of SW1's micro-switches and related numerical intervals.**

Numerical interval	F1	F2	F3	F4	F5	F6	F7	F8	F9	F10
Position of SW1's micro-switches										





## PROGRAMMING

### Preliminary notes

- To manage videointercom or intercom addresses connected to the lines LS are available 10 numerical intervals (F1÷F10). In each numerical interval can be stored the address of a single device or the first and the last address of a group of intercoms/videointercoms, with sequential addresses, related to the same line. For example if in the numerical interval F1 is stored the address 100, on the line LS only the calls addressed to the intercom/videointercom 100 is delivered. Vice-versa if on the same numerical interval F1 are stored the addresses 100 and 120, on the line LS are delivered the call addressed to all the intercoms/videointercoms whose address is between 100 and 120.
- To enable the secondary door station, if present in the riser, you need to store, in one of the 10 numerical intervals, the address of the door station connected to terminals LP. Use the other numerical intervals to store the addresses of any additional door stations connected to the LP terminals.
- **Attention:** if during the programming some error are made or if later it is necessary to modify some addresses already stored in the memory of the buffer art.2231Q, it is necessary to erase the whole memory of the device executing the "memory erasing" procedure and than reprogramming completely the device.

### Programming the numerical intervals

To program the numerical intervals F1÷F10 it is necessary:

- 1) select the numerical interval to be programmed, positioning the micro switches of SW1 according to the instructions provided in table 1 on previous page; red LED flashes quickly. For example, to program the interval F1, set to ON micro switch 1 of SW1 leaving OFF micro switches 2, 3 and 4; 
- 2) store the address of the external door station or internal station by following the procedure described here below.
  - Videointercom Zhero, myLogic: press the button .
  - Videointercom Exhito: press the button .
  - Intercom Exhito, Compact: pick up the handset, press the button , hang up the handset
  - Make a call, from secondary door stations.

In case you wish to program a group of addresses, store the address with the lowest value first.




If the final group address also has to be programmed in the interval, continue with step 3; if, on the other hand, only one address needs to be programmed, move on to step 4.

### Notes.

- Proper storage is indicated by the buffer LED turning off for one second and then turning back on in flashing mode.
  - Possible audio noise signals in this phase don't notice any anomaly in the programming.
- 3) From the internal station, having the user address with the highest value, store the address following the procedure of the selected model. The device acquires the address of the last internal station belonging to the group, allowing all the extensions programmed in interval F1 to connect to the LS line.
  - 4) Set OFF the microswitch 1 of SW1. This operation ends the programming phase of the numerical interval F1
  - 5) If required, proceed in a similar way to program the other 9 numerical intervals repeating the instructions reported on points from 1 to 4 and paying attention to set properly the microswitches of SW1 according to the numerical interval to be programmed (see table 1 on previous page).
  - 6) Set OFF all the microswitches of SW1 and exit the programming mode; red LED comes back flashing slowly
  - 7) Verify the correct operations of door stations and of intercoms/video-intercoms connected to line LS of the art.2231Q.

### Memory erasing

To erase all the data stored in the memory of the device it is necessary:

- set ON microswitches 1,2 and 4 of SW1 and leave OFF the microswitch 3 of SW1; red LED flashes quickly 
- wait for about 4 seconds; red LED lights up continuously;
- within 4 seconds set ON the microswitch 3; red LED turns OFF for about 2 seconds and than starts again flashing quickly; 
- at this stage all data have been erased;
- set OFF all the SW1 micro-switches; red LED comes back flashing slowly. 

### Automatic programming (code 15):

See page 4.19.

## DUO Extended Range.

### Functional Features.

The Line Buffer 2231Q is compatible with DUO digital systems and increases their potentialities by allowing the system to be divided into **99 blocks with 200 users** each. 19,800 users can therefore be managed in the system (**Duo System Extended Range**). To achieve this, each buffer is identified by a block address (block of the system to which the device belongs: from 01 to 99). The block 00 (i.e. not programmed) is reserved for compatibility with the existing products of DUO systems. Within each block 200 calls can be managed.



**Warning:** for correct operation of the system the main entrance units and devices connected to LI-LI or LO-LO lines must be set up for the DUO Extended Range, while the secondary entrance units and devices connected to LP-LP or LS-LS lines may be of the traditional type (DUO). Secondary entrance door stations connected to the LS-LS line must have addresses between **245 and 253**, addresses which cannot be attributed to the main entrance door stations, which can have addresses between 231 and 244.

### Line buffer programming

For operation in Duo Extended Range mode, the block address of the 2231Q Line Buffer must be programmed as follows:

- 1) position microswitches 2, 3 and 4 of SW1 to ON, leaving switch 1 OFF.



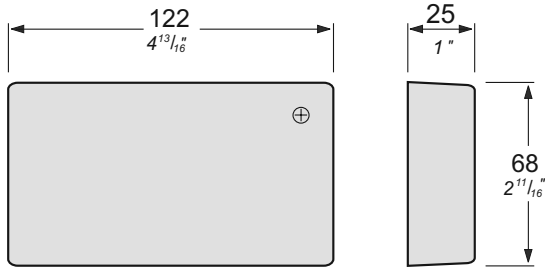
The red LED should flash quickly.

- 2) From one of the secondary entrance door stations, connected to the LP-LP inputs of the device, make a call to the desired block number and the device will automatically store the value. For example, if you want to programme the address of block 24 in the 2231Q Line Buffer, you must send a call, from the secondary entrance door station, connected to it, to the number 24.
- 3) Return all the microswitches of SW1 to OFF. The red LED should return to blinking slowly.





**LINE DISTRIBUTOR**



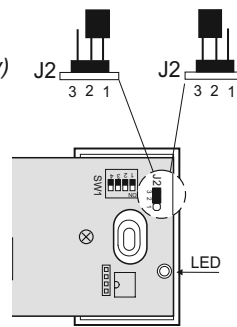
**Position of J2's jumper and related function**

**Operating mode**

**1-2 position**  
(Red LED flashes slowly)

**Programming mode**

**2-3 position**  
(Red LED flashes quickly)



**DM2421.** In DUO digital system the DM2421 line distributor allows the selective sending of the video signal, coming from two door stations to one riser or from one door station to two risers, according to the addresses programmed in the device; audio and call signals, on the contrary, are delivered to all the devices connected to the lines without considering their address. The LED, present in the device, turns on the L2 switching and for all the time of activation of the DUO system.

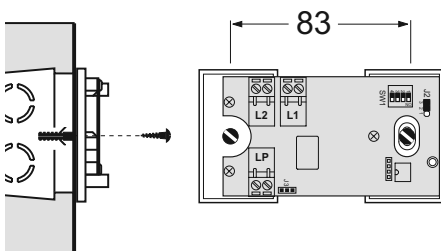
**Technical features**

Power supply from the line	
Stand-by current:	8mA
Operating current:	50mA
Housing:	122x68x25mm
Operating temperature:	0° ÷ +50°C
Maximum humidity acceptable:	90% RH
Fits with 2 expansion plugs	

**Terminals**

- LP - LP Line input
- L1 - L1 Line 1
- L2 - L2 Line 2

**INSTALLATION**



**PROGRAMMING**

**Preliminary notes**

To manage **device addresses** (external stations / internal stations) connected to the line L2 are available 10 numerical intervals (F1÷F10).

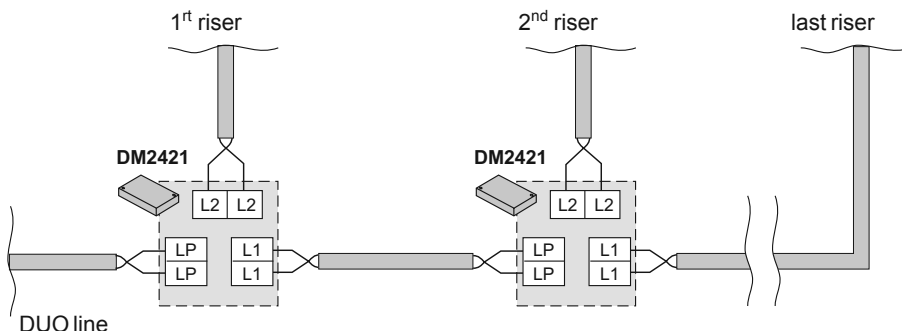
In each numerical interval can be stored the address of a single device or the first and the last address of a group of devices, with sequential addresses. *For example*, if in the numerical interval F1 is stored the address 100, on the line L2 only the video signal of the call addressed to the videointercom 100 is delivered. Vice-versa if on the same numerical interval F1 are stored the addresses 100 and 120, on the line L2 are delivered the video signals of the calls addressed to all the videointercoms whose address is between 100 and 120. The addresses not included in intervals F1÷F10 are forwarded to line L1.

**Attention:** if during the programming some error are made or if later it is necessary to **modify some addresses already stored in the memory**, it is necessary to **erase the whole memory of the device** executing the "memory erasing" procedure and than reprogramming completely the device.

**Programming the numerical intervals**

To program the numerical intervals **F1÷F10** it is necessary:

- 1) enter the programming mode moving the **jumper J2** from position **1-2** to **2-3**; the red LED flashes quickly;
- 2) select the numerical interval to be programmed, positioning the micro switches of **SW1** according to the instructions provided in table 4.4 on page 4.12.



*For example*, to program the interval **F1**, set to **ON micro switch 1** of **SW1** leaving **OFF** micro switches 2, 3 and 4;

- 3) store the address of the device by following the procedure described here below.
  - Videointercom **Zhero**, **myLogic**: press the button
  - Videointercom **Exhito**: press the button
  - Intercom **Exhito**: pick up the handset, press the button , hang up the handset
  - Door stations, make a call.

In case you wish to program a group of addresses, store the address with the lowest value first.

If the final group address also has to be programmed in the interval, continue with step **4**; if, on the other hand, only one address needs to be programmed, move on to step **5**.

**Notes.**

- Proper storage is indicated by the distributor LED turning off for one second and then turning back on in flashing mode.
- Possible audio noise signals in this phase don't notice any anomaly in the programming.

- 4) From the external station / internal station, having the user address with the highest value, store the address following the procedure of the selected model. The device acquires the address of the last external station / internal station belonging to the group, allowing all the extensions programmed in interval **F1** to connect to the **L2** line.

**Table 4.4.**  
Position of SW1's microswitches and related programming function

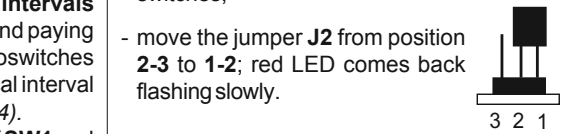
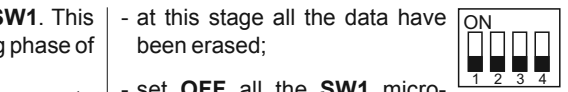
Position of SW1's microswitches	Programming function
	numerical interval F1
	numerical interval F2
	numerical interval F3
	numerical interval F4
	numerical interval F5
	numerical interval F6
	numerical interval F7
	numerical interval F8
	numerical interval F9
	numerical interval F10
	memory erasing

- 5) Set **OFF** the microswitch 1 of **SW1**. This operation ends the programming phase of the numerical interval **F1**.
- 6) If required, proceed in a similar way to program the other **9 numerical intervals** repeating the points from 2 to 5 and paying attention to set properly the microswitches of **SW1** according to the numerical interval to be programmed (see table 4.4).
- 7) Set **OFF** all the microswitches of **SW1** and exit the programming mode moving jumper **J2** from position **2-3** to **1-2**; red LED comes back flashing slowly.
- 8) Verify the correct operations of door stations and of intercoms/video intercoms connected to line **L2** of the art. **DM2421**.

### Memory erasing

To erase all the data stored in the memory of the device it is necessary:

- move the jumper **J2** from position **1-2** to **2-3**; red LED starts flashing quickly;
- set **ON** the microswitches **1,2** and **4** of **SW1** and leave **OFF** the microswitch **3** of **SW1**;
- wait for about 4 seconds; red LED lights up continuously;
- within 4 seconds set **ON** the microswitch **3**; red LED turns OFF for about 2 seconds and than starts again flashing quickly;



### OPERATION

The device has one input line (**LP**) and two output lines (**L1** and **L2**); data and audio signals are always distributed over three lines, while the video signal coming from the LP line is selectively switched to line L1 or L2, depending on how the device has been programmed.

The programming procedure requires to indicate only the addresses of devices connected to **line L2**; it is automatically assumed that all the other addresses belong to line L1.

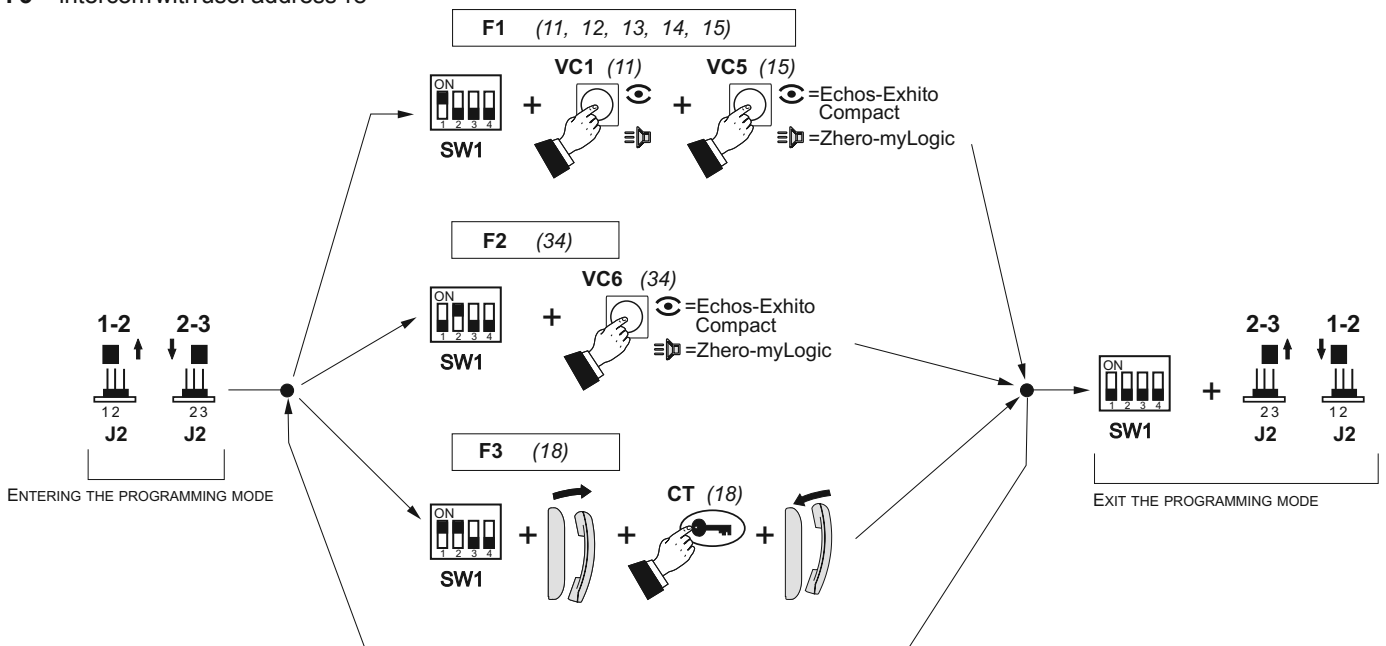
When a device belonging to line L2 is called, the DM2421 distributor sends the video signal on line L2, disconnecting line L1; the video signal of the remaining calls is sent to line L1.

### Example programming of 3 intervals (F1÷F3) for one distributor art. DM2421.

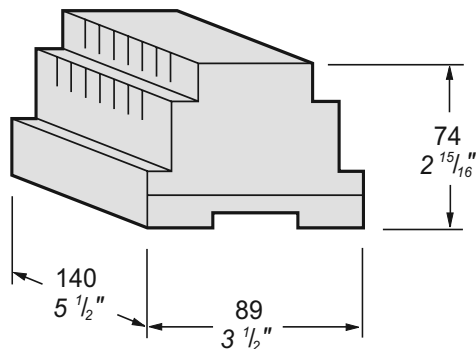
**F1** = video intercoms with user addresses from 11 to 15.

**F2** = video intercom with user address 34

**F3** = intercom with user address 18



## 4 INPUTS AND 4 OUTPUTS LINE DISTRIBUTOR



**DM2444.** In digital installations DUO the line distributor DM2444 allows to distribute the video signal coming from several external door stations to the internal videointercoms according to the addresses programmed in the address intervals of the output lines; audio and calling signals are on the contrary distributed to all the devices without taking care of their address.

**Warning.** The device do not allows multiple calls and conversations. A call originated from any external door station makes busy all the other input and output lines until the end of the conversation.

### Technical features

Power supply from the line  
 Stand-by current: 15mA  
 Operating current: 40mA  
 Housing: 8 module A DIN  
 Operating temperature: 0° ÷ +50°C  
 Maximum humidity acceptable: 90% RH  
 Fits on DIN bar or with 2 expansion plugs

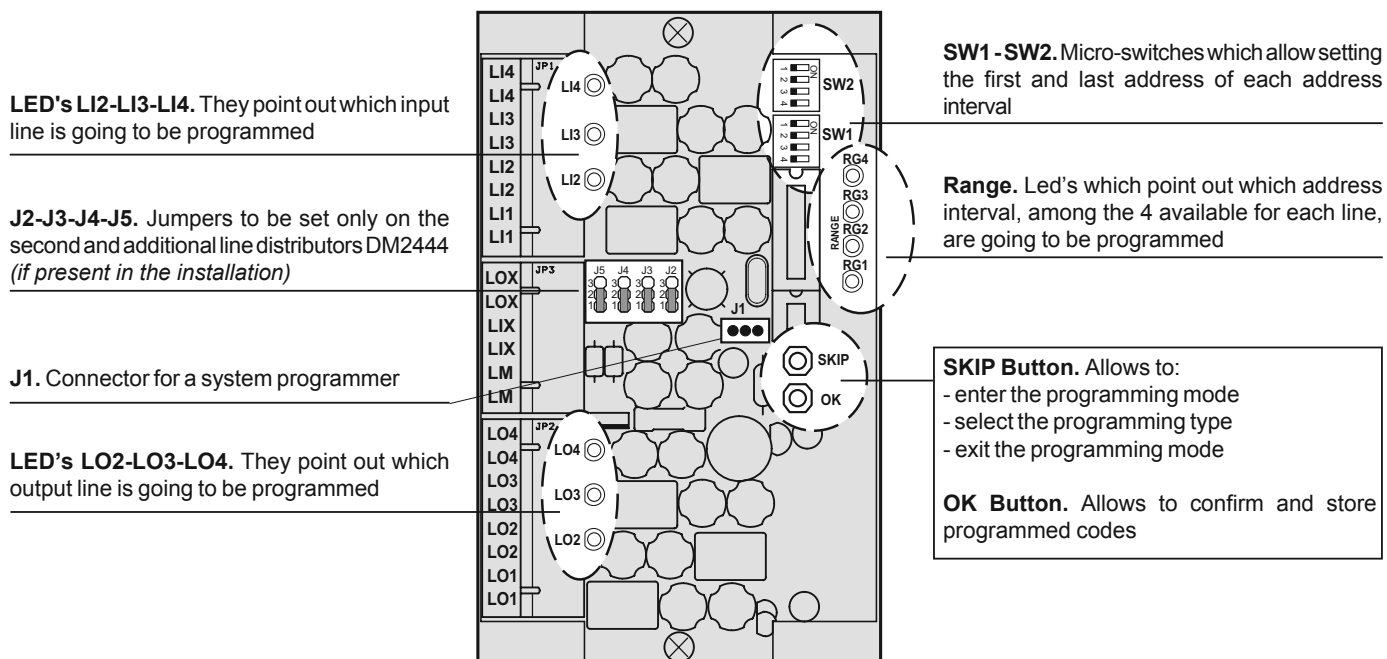
### Terminals

**LM** Power supply input  
**LI1 ÷ LI4** Line inputs  
**LO1 ÷ LO4** Line outputs  
**LOX (\*)** Connection to the output line (LO1) of a previous line distributor  
**LIX (\*)** Connection to the input line (LI1) of a previous line distributor

(\*) Connection to be made only if more than 1 line distributor DM2444 are present in the system.

## PROGRAMMING

### Functions of LED's, buttons and micro-switches during the programming phase



## Preliminary notes

- If input lines **LI2**, **LI3**, **LI4** and output lines **LO2**, **LO3**, **LO4** are connected to the system, they must be programmed to allow the management of the related addresses.
- Lines **LI1** and **LO1** must not be programmed; line distributor will send automatically on LI1 and LO1 all the addresses of the system which are not programmed in any address intervals of the other lines.
- For the management of the addresses of the devices connected to the lines **LI2**, **LI3**, **LI4**, **LO2**, **LO3** and **LO4**, are available 4 address intervals (**RG1+RG4**) for each line. In each address interval of an input or output line, can be stored the address of a single device or the first and last address of a group of devices (see example 1b). The addresses to be stored in the address intervals of the lines **LI2**, **LI3**, **LI4** start from 231 up to 250 and must correspond to those stored in the devices (normally external door stations) connected to those lines. The addresses to be stored in the address intervals of the lines **LO2**, **LO3**, **LO4** start from 001 up to 200 and must correspond to those stored in the devices (normally videointercoms) connected to those lines.

## Examples.

- 1a - If in the address interval **RG1** of the line **LO2** is stored the address 100, on **LO2** will be diverted the video signal for calls addressed only to the videointercom 100.
- 1b - If in the same **RG1**, on the contrary, are stored addresses 100 (the lowest address) and 120 (the highest address), on the **LO2** line will be diverted the video signal for calls addressed to any videointercom whose address is between 100 and 120.
- 2 - If in the address interval **RG1** of the line **LI2** is stored the address 232, the external door station connected to the line **LI2** must be coded with the address 232 and would be able to send calls to any videointercom.

- **Attention:** whether in the line distributor DM2444 it is made an **error** during the programming phase or later it is requested to **modify the already stored addresses**, it is necessary to **erase the whole memory of the device** by executing the procedure "Clearing the memory of the device" and then program again completely the device to avoid undesired programming.

## Entering the programming mode

- Remove the cover of the device to access to the programming buttons.
- Keep pressed the **SKIP** button as long as the Led **LI2** will light-up and the Led **RG1** starts flashing.



## Exit the programming mode

- It is possible to exit the programming mode following one of the following two procedures:
- keep pressed the **SKIP** button as long as all the led's **RG1**, **RG2**, **RG3** and **RG4** start flashing in a sequential way;
  - disconnect and connect again the power supply of the device.

**Warning.** You will exit automatically the programming mode if for about 5 minutes no operations are made; all the data entered until that moment will be automatically stored.

## Programming the address intervals

To program the address intervals of the lines **LI2+LI4** and **LO2+LO4**, it is necessary:

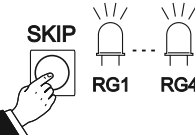
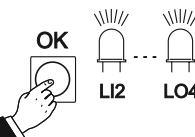
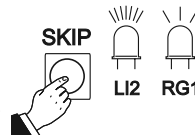
- 1) keep pressed the **SKIP** button as long as the Led **LI2** will light-up and the Led **RG1** starts flashing;
- 2) enter the address of the first device (the lowest address) you wish to assign to the **address interval RG1** of the line **LI2**. To enter the address you can choose one of the two following procedures:
  - a)- from the device with the lowest address connected to the line **LI2** (for instance an external door station) make a call to any internal users (the system will automatically store the address of the calling device and not that of the called device); correct storing of data is confirmed by the simultaneous lighting-up of all the 4 **RG** led's;
  - b)- using micro-switches **SW1** and **SW2** set the address to be stored in the address interval **RG1** (see table 4.5);
    - Press the **OK** button; correct storing of data is confirmed by the simultaneous lighting-up of all the 4 **RG** led's;
 If in this address interval only one address should be stored proceed directly to point "4".
- 3) enter the address of the last device (the highest address) you wish to assign to the **address interval RG1** of line **LI2**. To enter the address use one of the two procedures shown in the previous points "a" and "b";
- 4) - press the **SKIP** button to move to the programming of **address interval RG2** of the **LI2** line; Led **LI2** remains ON, Led **RG1** turns OFF and Led **RG2** starts flashing;
  - to program the address interval **RG2** proceed as indicated at the points "2" and "3";
  - if it is not necessary to program the address intervals **RG2**, **RG3** and **RG4**, press several times the **SKIP** button until the Led **LI3** lights-up and Led **RG1** starts flashing;
- 5) - proceed as indicated at the points "2", "3" and "4" to program the address intervals **RG1**, **RG2**, **RG3** and **RG4** of the lines **LI3** and **LI4**;
  - if it is not necessary to program the address intervals of those lines, press several times the **SKIP** button until the Led **LO2** lights-up and Led **RG1** starts flashing;
- 6) - proceed as indicated at the points "2", "3", "4", and "5" to program the address intervals of output lines **LO2**, **LO3** and **LO4**. The only difference is the point "2a". In this case the storage of the first (the lowest address) and the last address (the highest address) can be done by pressing the button  (for videointercoms **Exhito** series) or the button  (for videointercoms **myLogic** and **Zhero** series) of videointer-coms with the lowest and highest address which should be stored in the selected address interval;
- 7) exit the programming mode as reported in the chapter "exit the programming mode"

- 8) verify the correct operation of the system.

## Clearing the memory of the device

To erase completely the memory of the device, it is necessary:

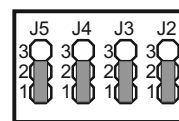
- enter the programming mode by pressing the **SKIP** button; Led **LI2** lights-up and Led **RG1** starts flashing;
- set the micro-switches of **SW1** and **SW2** to the value **85** moving the switch 1 and 3 of both **SW1** and **SW2** to **ON** position ;
- keep pressed the **OK** button until all the 6 Led's **LI2**, **LI3**, **LI4**, **LO2**, **LO3** and **LO4** momentarily light-up; the device memory has been completely cleared;
- keep pressed the **SKIP** button to exit the programming mode.



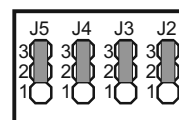
## Connecting several distributors to have a greater number of risers and/or external door stations

If more than 4 input (door stations) and/or output lines (risers) are required, add one or more line distributor DM2444.

For correct operations of line distributors, set the jumpers **J2**, **J3**, **J4** and **J5** in the following way:



**Position 1 - 2**  
On the first line distributor (factory setting)



**Position 2 - 3**  
On the second and additional line distributors

**Table 4.5**

**Cross-reference table between codes and microswitches position of SW1 and SW2.**

	SW2	SW1		SW2	SW1		SW2	SW1		SW2	SW1		SW2	SW1
1			21			41			61			81		
2			22			42			62			82		
3			23			43			63			83		
4			24			44			64			84		
5			25			45			65			85		
6			26			46			66			86		
7			27			47			67			87		
8			28			48			68			88		
9			29			49			69			89		
10			30			50			70			90		
11			31			51			71			91		
12			32			52			72			92		
13			33			53			73			93		
14			34			54			74			94		
15			35			55			75			95		
16			36			56			76			96		
17			37			57			77			97		
18			38			58			78			98		
19			39			59			79			99		
20			40			60			80			100		

# SERVICE MODULES

101		124		147		170		193	
102		125		148		171		194	
103		126		149		172		195	
104		127		150		173		196	
105		128		151		174		197	
106		129		152		175		198	
107		130		153		176		199	
108		131		154		177		200	
109		132		155		178		201	
110		133		156		179		202	
111		134		157		180		203	
112		135		158		181		204	
113		136		159		182		205	
114		137		160		183		206	
115		138		161		184		207	
116		139		162		185		208	
117		140		163		186		209	
118		141		164		187		210	
119		142		165		188		211	
120		143		166		189		212	
121		144		167		190		213	
122		145		168		191		214	
123		146		169		192		215	

## SERVICE MODULES

216		224		232		240		248	
217		225		233		241		249	
218		226		234		242		250	
219		227		235		243		251	
220		228		236		244		252	
221		229		237		245		253	
222		230		238		246		254	
223		231		239		247		255	

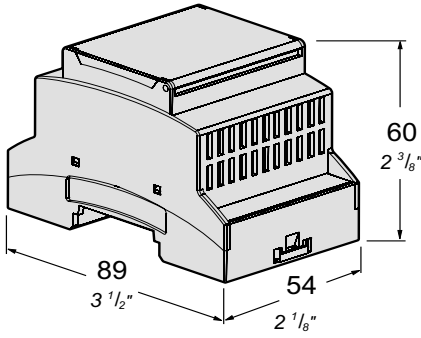
**Table 4.6**  
Example of programming the inputs and outputs of a DM2444 riser distributor

Lines	Address intervals								
	RG1		RG2		RG3		RG4		
	from:	to:	from:	to:	from:	to:	from:	to:	
INPUTS	LI1	Not programmed; accepts all addresses, except those inserted in the interval of lines LI2, LI3 and LI4.							
	LI2	232							
	LI3	233							
	LI4	234		235					
OUTPUTS	LO1	Not programmed; accepts all addresses, except those inserted in the interval of lines LO2, LO3 and LO4.							
	LO2	21	25	37		55		83	91
	LO3	100	114	132	144				
	LO4	121							

The example in the table assumes that:

- the transit of all the door station addresses from 231 to 250, except the addresses 232, 233, 234 and 235, is allowed on the **LI1** line;
- the transit of the door station address 232 is allowed on the **LI2** line;
- the transit of the door station address 233 is allowed on the **LI3** line;
- the transit of the door station addresses 234 and 235 is allowed on the **LI4** line;
- the transit of all the internal station addresses from 1 to 200, except the addresses from 21 to 25, 37, 55, from 83 to 91, from 100 to 114, from 132 to 144 and 121, is allowed on the **LO1** line;
- the transit of all the internal station addresses from 21 to 25, 37, 55 and from 83 to 91, is allowed on the **LO2** line;
- the transit of all the internal station addresses from 100 to 114 and from 132 to 144, is allowed on the **LO3** line;
- the transit of the internal station address 121, is allowed on the **LO4** line.

**VIDEO MODULATOR**



**VM2521.** When one or two supplementary analog video cameras are connected to it (e.g. CCTV cameras), the VM2521 video modulator allows their PAL video signals to be sent on the Farfisa DUO bus.

The modulator connects directly to the DUO line without the need for a dedicated power supply.

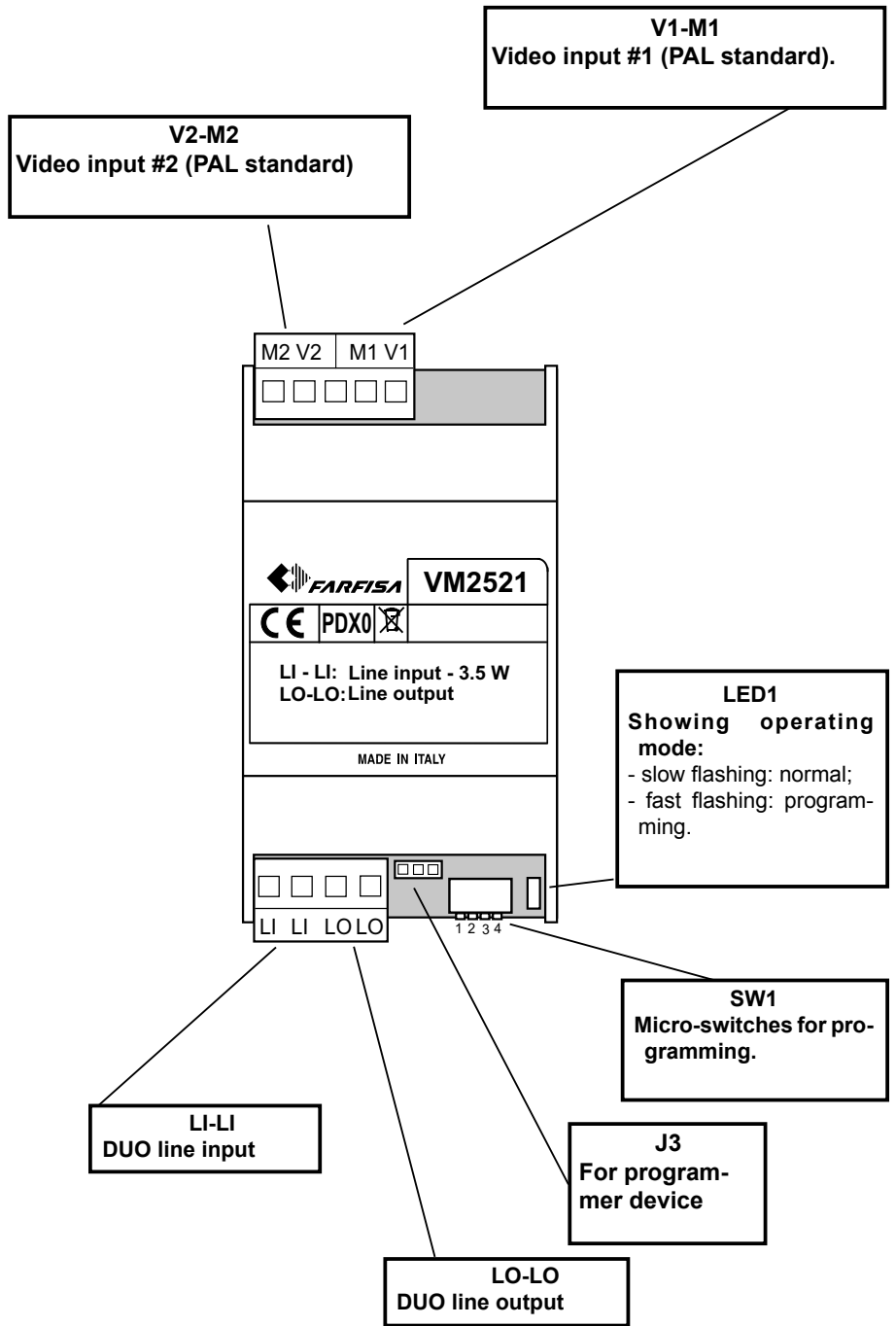
**Technical features**

Power supply: from DUO line  
 Power consumption: - stand-by 10mA  
 - operating 100mA  
 Enclosure: DIN 3 A modules  
 Operating temperature: 0° ÷ +50°C  
 Max Humidity: 90% RH

**Terminals**

**V1 - M1** Input video signal #1 (PAL)  
**V2 - M2** Input video signal #2 (PAL)  
**LI - LI** DUO line input  
**LO - LO** DUO line output

Position of connectors e related function.





## INSTALLATION

The VM2521 video modulator must be located along a section of the DUO bus and serves to connect 1 or 2 PAL colour video cameras (V1-M1 and V2-M2 inputs, where V is the video signal and M is the video ground) to the system.



**Caution:** for correct system operation, the supplementary video cameras must have a video ground that is isolated from the earth conductor.

The device is powered from the line and does not require any local power supply. Its power consumption must therefore be considered in the overall load calculation for the line power supply.

For each input (V1-M1 or V2-M2), two addresses can be stored, among those reserved for external stations (231 - 250). The two addresses allow the inputs to be displayed individually (different addresses for each video input) or sequentially (the same address for the two video inputs). For example, if addresses 231 and 232 are assigned to video input #1 and addresses 231 and 233 to video input #2, by connecting to the door station 232, you will receive the picture from the first video camera, by connecting to the door station 233, you will receive the picture from the second video camera, while any time you connect to the door station 231, you will receive alternatively the picture from the first video camera and that from the second one. The VM2521 modulator can operate as an "independent device" or as a "device controlled by a door station already in the system". Its operating mode is set by received commands, so the device does not require any specific programming, but it is the door station that must be appropriately programmed to control the modulator.

When the modulator operates in "independent device" mode, it behaves like an external video station, without the audio functions and without the possibility to make calls. Therefore, it is possible to connect to it from any internal station (using the addresses of its two inputs). When the modulator operates as a "device controlled by an external station already in the system", the control of its video cameras is integrated with any video cameras on the door station (read the instruction manual of the door station for details of its operation and programming).



**Attention:** the door stations, ready for interfacing the VM2521 video modulator, are identified by revision PDX1.

## PROGRAMMING

### Preliminary information

Use the DIP switch SW1 to enter the programming mode. The following programming is possible:

- First address of video input #1.
- Second address of video input #1.
- First address of video input #2.
- Second address of video input #2.
- Delete the stored data and return to the factory values.
- Set up for automatic programming (with the **PGR2990** programmer).

### Programming the first address of video input #1 (code 01)

- Using the button on any internal station that can be connected to the video modulator, store the first address that you want to assign to video input #1 of the modulator.
- On the modulator, position DIP switch SW1 to compose the code 01.



LED1 will flash quickly.

- On the internal station, press the button previously programmed with the address to be assigned to the input.
- LED1 will turn OFF for about 1 second and then it will start flashing quickly again to indicate that the programming has been carried out.

### Programming the second address of video input #1 (code 02)

- Using the button on any internal station that can be connected to the video modulator, store the second address that you want to assign to video input #1 of the modulator.
- On the modulator, position DIP switch SW1 to compose the code 02.



LED1 will flash quickly.

- On the internal station, press the button previously programmed with the address to be assigned to the input.
- LED1 will turn OFF for about 1 second and then it will start flashing quickly again to indicate that the programming has been carried out.

### Programming the first address of video input #2 (code 06)

- Using the button on any internal station that can be connected to the video modulator, store the first address that you want to assign to video input #2 of the modulator.
- On the modulator, position DIP switch SW1 to compose the code 06.



LED1 will flash quickly.

- On the internal station, press the button previously programmed with the address to be assigned to the input.
- LED1 will turn OFF for about 1 second and then it will start flashing quickly again to indicate that the programming has been carried out.

### Programming the second address of video input #2 (code 07)

- Using the button on any internal station that can be connected to the video modulator, store the second address that you want to assign to video input #2 of the modulator.
- On the modulator, position DIP switch SW1 to compose the code 07.



LED1 will flash quickly.

- On the internal station, press the button previously programmed with the address to be assigned to the input.
- LED1 will turn OFF for about 1 second and then it will start flashing quickly again to indicate that the programming has been carried out.

### Erasing the stored data (code 11)

To delete the data stored in the device memory:

- position DIP switch SW1 to compose the code 11



LED1 will flash quickly.

- Wait for about 4 seconds; LED1 will remain ON continuously.
- Within 4 seconds move microswitch 3



LED1 will turn OFF for about 2 seconds, then it will start flashing quickly again.

- All the data stored in the device has been erased.

### Setting up automatic programming (code 15)

The video modulator can also be programmed by connecting the **PGR2990** programmer to connector J3 (automatic programming). To enable automatic programming:

- position DIP switch SW1 to compose the code 15



LED1 will flash quickly.

- Connect the **PGR2990** programmer to connector J3.
- Program the device.
- Disconnect the **PGR2990** programmer from connector J3.

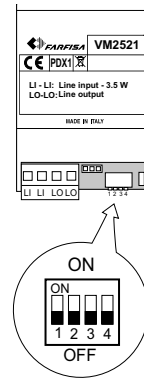


**Warning:** after programming, return all the DIP switches of SW1 to the OFF position



LED1 will flash slowly again.

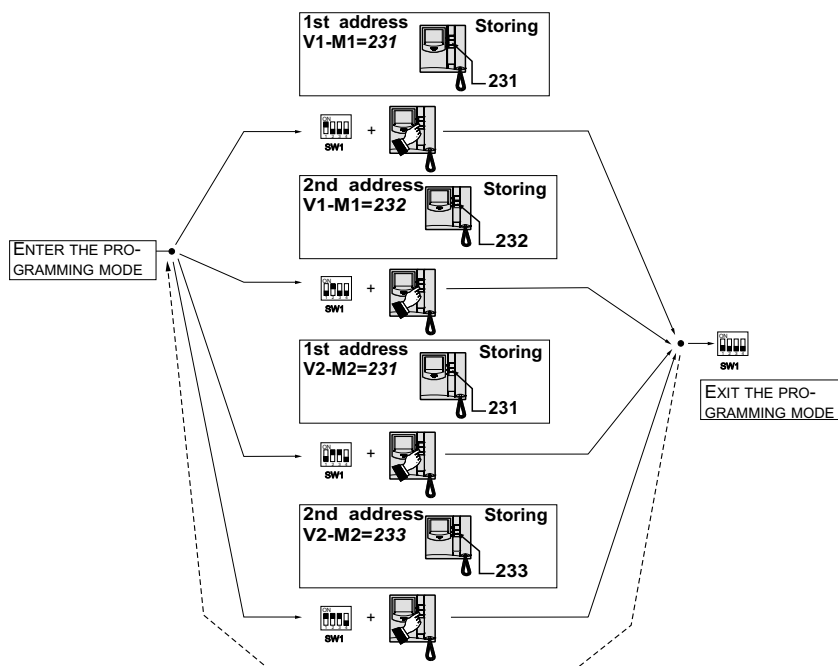




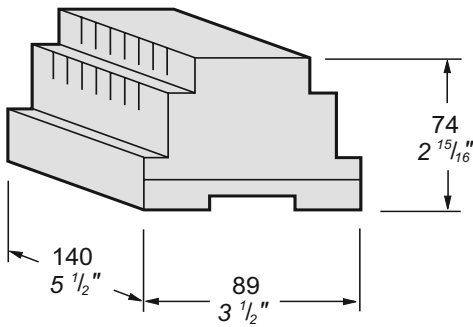
**Table 1 - Position of SW1's micro-switches and related programming.**

Programming	First address of video input #1	Second address of video input #1	First address of video input #2	Second address of video input #2	Erasing memory data	Automatic programming
	Position of SW1's micro-switches					

**Example of programming** a VM2521 video modulator with the first address of video input #1=231, the second address of video input #1=232, the first address of video input #2=231 and the second address of video input #2=233.



**4- OR 7-EXCHANGE SELECTOR**



**2287.** The device, controlled by the commands coming from the DUO digital line, allows for the selection of up to 4 or 7 surveillance cameras and/or the activation of other services. The relays of the device switch cyclically every time the selector receives the activation address of the cyclic operation, or you can select the individual outputs by sending to the device the address of the output to be switched.

**Technical features**

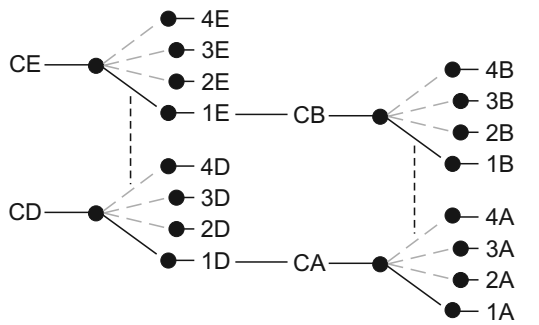
- Power supply from the line
- Stand-by current: 15mA
- Operating current: 40mA
- Housing: DIN 8 modules A
- Operating temperature: 0° ÷ +50°C
- Maximum humidity acceptable: 90% RH
- Fits on DIN bar or with 2 expansion plugs

**Terminals**

- LM - LM** Line inputs
- CA - CB** Common to exchanges 1A/B÷4A/B
- 1A/B ÷ 4A/B** Outputs of lines A and B
- CD - CE** Common to exchanges 1D/E÷4D/E
- 1D/E ÷ 4D/E** Outputs of lines D and E

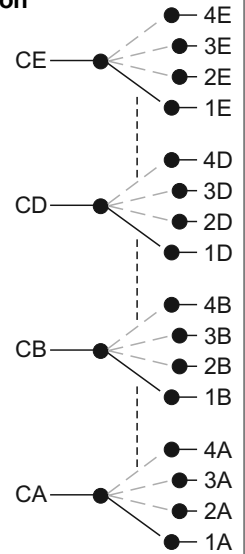
**7-exchange operation**

With this setting, you need to connect the outputs 1D and 1E respectively to the common CA and CB; the outputs are enabled independently (1A/B, 2A/B, 3A/B, 4A/B, 2D/E, 3D/E, 4D/E).



**4-exchange operation**

With this setting the outputs with the same number are simultaneously enabled (1A/B/D/E, 2A/B/D/E, 3A/B/D/E, 4A/B/D/E).



**PROGRAMMING**

**Functions of the LED's, buttons and micro-switches during the programming phase**

**LED's LI2-LI3-LI4.** Indicate which output (1÷4D/E with common CD and CE) is being programmed.

**J1.** Connector for a system programmer.

**LED's LO2-LO3-LO4.** Indicate which output (1÷4A/B with common CA and CB) is being programmed.

**SW1 - SW2.**  
Micro switches that allow:  
- the activation of the only outputs connected during the cyclic operation;  
- entry of the addresses during programming.

**Range RG1÷RG4.**  
LEDs indicating the confirmation of the correct programming (cyclic or fixed light) or normal operation (flashing light).

**SKIP button.** Allows:  
- to access programming;  
- to select the type of programming;  
- to exit programming.

**OK button.** Allows:  
- to confirm the programming;  
- to access and change the setting from 4- to 7-exchange.

## Preliminary information

- The activation addresses of the outputs, as a rule, range from 211 to 230 and must match the addresses stored in the buttons (or contacts for the myLogic series) of the videointercoms connected to the DUO line.
- The selector from factory is programmed according to the instructions in the chapter "Factory settings"; for any changes it is necessary to first indicate whether the item must operate at 4- or 7-exchange and then enter the operating modes and activation codes of the outputs.

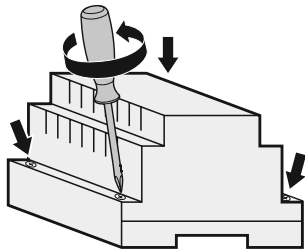
## Factory setting

- **4-exchange** operating mode (simultaneous switching of outputs ).
- Address **211** for the cyclic and contemporary activation of the outputs from 1 to 4.
- **No address stored** for the activation of the individual outputs.
- All outputs **used** (ON position of all the SW1 and SW2 micro-switches).

## Programming mode steps

- 1 - Remove the cover to access the buttons and programming micro-switches.
- 2 -Set the device to operate at 4 or 7 exchanges.
- 3 - Enter the activation codes of the outputs.
- 4 - Enable the only outputs connected.

### 1 - Remove the cover



### 2 - Programming of the operating mode to 4 or 7 exchanges

To change the operating mode of the device, it is necessary to:

- press and hold the **OK** button until the continuous lighting of the LEDs **RG1+4** according to the current setting (all 4 LEDs if in **4** exchange mode or only the LED **RG1** if in **7** exchange mode);
- press **OK** to modify it and wait until the LEDs indicate the confirmation of the new operating mode (continuous lighting of the LED **RG1** if **7-exchange**; of the 4 **RG1+4** LEDs if **4-exchange**);
- to exit the programming, press and hold **SKIP** until the LEDs **RG1+4** start to flash if **4-exchange** or the sole LED **RG1** starts to flash if **7-exchange**.

### 3 - Output activation address programming

The programming of addresses for enabling outputs has the following path:

- Enter the programming mode
- Program the **cyclic** operation
- Program the individual outputs to enable **individual** in the following order:
  - 4-exchange** version: 1 A/B/D/E - 2 A/B/D/E - 3 A/B/D/E - 4 A/B/D/E
  - 7-exchange** version: 1A/B - 2A/B - 3A/B - 4A/B - 2D/E - 3D/E - 4D/E
- Exit programming mode.

#### a) Enter the programming mode

- Hold down the **SKIP** button until the 4 LEDs **RG1+4** light up sequentially.

#### b) Program the cyclic operation

- The cyclic operation allows you to switch the outputs by pressing one single button from the videointercom. Each press will sequentially enable the **activated** outputs (see section "Activation/deactivation of the outputs") starting from 1A/B to 4D/E (if 7-exchange) or 1A/B/D/E to 4A/B/D/E (if 4-exchange); by continuing to press, it restarts from the output 1 A/B.

To enter or disable the address use one of 3 methods described in the section "how to enter addresses while programming" then exit as described in the section "exit the programming mode" or press **SKIP** to switch to the programming of selective addresses for the outputs **1A**

Table 4.8

Cross-reference between codes and microswitches position of SW1 and SW2.

	SW2	SW1		SW2	SW1
211			221		
212			222		
213			223		
214			224		
215			225		
216			226		
217			227		
218			228		
219			229		
220			230		

and **1B** (with **2D** and **2E** if 4-exchange); the 4 LEDs **RG1+4** will light up steadily.

## How to enter addresses while programming

To enter addresses, you can follow one of the following 3 procedures:

- send the address to be stored in the selector by pressing the button of the videointercom previously programmed with this address; confirmation of storage is indicated by the temporary power OFF and subsequent sequential power ON (cyclic programming) or fixed power ON (individual programming) of the 4 LEDs **RG1+4**;
- via the micro switches **SW1** and **SW2** compose the **address** to be stored (the same address previously assigned to the **button of the videointercom** or of all videointercoms enabled). For the codes see table 4.8;
  - press **OK**; confirmation of storage is indicated by the temporary power OFF and subsequent sequential lighting (cyclic programming) or fixed lighting (individual programming) of the 4 LEDs **RG1+4**;
  - compose the address to be stored on the front panel keypad or the doorkeeper exchanger and press the Enter key; confirmation of storage is indicated by the temporary power OFF and subsequent sequential lighting (cyclic programming) or fixed lighting (individual programming) of the 4 LEDs **RG1+4**.

**Attention.** If you do not want the cyclic operation or enabling for one or more outputs, while entering the addresses, in the corresponding position, store the code **000** by setting all micro switches **SW1** and **SW2** to **OFF** position and pressing **OK** to confirm.



## 3) Programming the individual outputs

After programming the cyclic operation, you can program the outputs to be able to activate them **individually** by the buttons on the videointercom. The following tables show the programming sequences of the outputs and related illuminations of the LEDs.

### 4-exchange version

Outputs	1A	2A	3A	4A
	1B	2B	3B	4B
	1D	2D	3D	4D
	1E	2E	3E	4E
Led ON		LO2 LI2	LO3 LI3	LO4 LI4
	RG1÷4	RG1÷4	RG1÷4	RG1÷4

### 7-exchange version

Outputs	1A	2A	3A	4A	2D	3D	4D
	1B	2B	3B	4B	2E	3E	4E
Led ON		LO2	LO3	LO4	LI2	LI3	LI4
	RG1÷4	RG1÷4	RG1÷4	RG1÷4	RG1÷4	RG1÷4	RG1÷4

- Program the outputs 1 choosing one of the 3 methods described in the section "how to enter addresses while programming" then press the **SKIP** button to switch to the programming of the outputs 2A and 2B (including 2D and 2E if 4-exchange); in addition to the LEDs **RG1÷4** the LED **LO2** lights up (and **LI2** if 4-exchange).
- Program the outputs 2 choosing one of the 3 methods described in the section "how to enter addresses while programming" then press the **SKIP** button to switch to the programming of the outputs 3A and 3B (including 3D and 3E if 4-exchange); in addition to the LEDs **RG1÷4** the LED **LO3** lights up (and **LI3** if 4-exchange).
- Proceed to the complete programming of the selector or exit as shown in the following section.

### d) Exit the programming mode

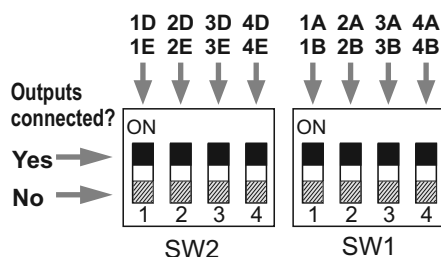
Press and hold the **SKIP** button until the flashing of all LEDs **RG1÷4** (or just **RG1** if set to 7-exchange).

#### Attention.

- If no operation is performed for **approximately 5 minutes** it automatically exits the programming mode; the data entered up to that point will be stored.
- Before using the device, do not forget to **set the micro switches SW1 and SW2** according to the devices connected to the selector (see next section).

### 4 - Activation/deactivation of the outputs

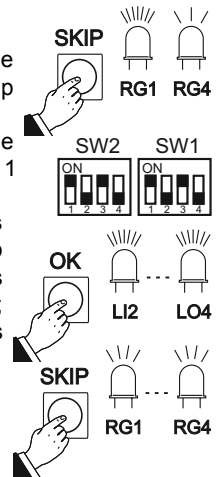
If using the cyclic mode it is recommended to disable the unused outputs in order to avoid image gaps during the scanning of cameras or non-activation of functions for other uses. To indicate the outputs used, set the micro switches **SW1** and **SW2** to **ON** (used outputs) or **OFF** (unused outputs) according to the following drawing.



## Return to factory settings

To restore the factory settings, you must:

- enter programming mode by holding down the **SKIP** button until the 4 LEDs **RG1÷4** light up sequentially;
- set the micro switches **SW1** and **SW2** with the value **85** bringing to **ON** position the levers 1 and 3 of both micro switches;
- press and hold the **OK** button until all **6 LEDs LI2, LI3, LI4, LO2, LO3 and LO4** light up momentarily; at this point the memory has been cleared and factory settings are restored;
- press and hold the **SKIP** button until the LEDs **RG1÷4** start flashing.



## OPERATION

The outputs of the selector can be enabled in **cyclic** mode using one single button from the videointercom and/or **individually** by matching each button of the videointercom to a specific output.

#### Attention.

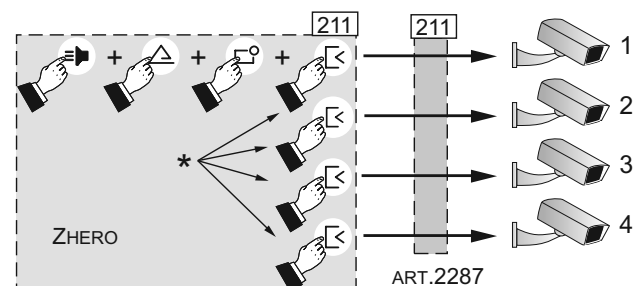
- The buttons of the videointercom must be programmed with the same addresses (codes 211 to 230) of the active outputs of the selector.
- If the videointercom does not turn on, it is likely that the line is occupied by another user; try after dial tone.
- During operation, the videointercom may turn off for the following reasons:
  - the 30-second period for turning on the videointercom has completed;
  - a call has been made from an external unit to another user.

#### ● Cyclic operation

For cyclic switching, it is necessary, from the videointercoms, to repeatedly press the button programmed for this function; each press sequentially switches the active outputs; when the last output is reached, by continuing to press, the switching restarts from the first output. Proceed as follows:

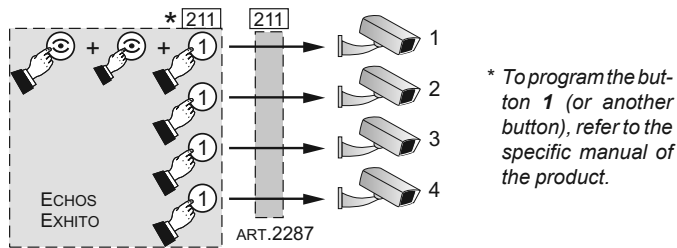
#### a) Zhero series

- press to turn ON the videointercom;
- press (symbol on the screen ) to enter the advanced functions;
- press "**monitor**" to activate the input of the surveillance camera (terminals **M** and **V** of the push-button panel);
- repeatedly press the button programmed for cyclic function (factory with the sign "actuacions").



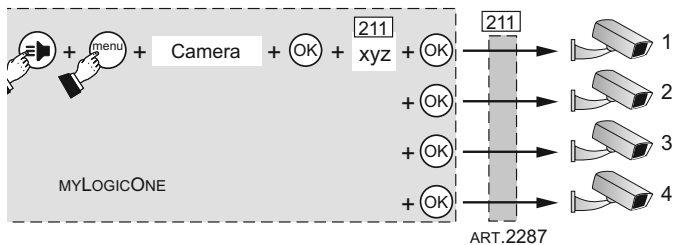
## b) Exhito series

- press to turn ON the videointercom;
- press again to activate the input of the surveillance camera (terminals **M** and **V** of the push-button panel);
- repeatedly press the button programmed for cyclic function.



## c) myLogicOne series

- press to turn ON the videointercom;
- press "menu" to display the list of services that can be activated;
- select "camera" for the activation of the surveillance camera (terminals **M** and **V** of the push-button panel) and press **OK**;
- select the **name** programmed for the cyclic operation and repeatedly press **OK**.



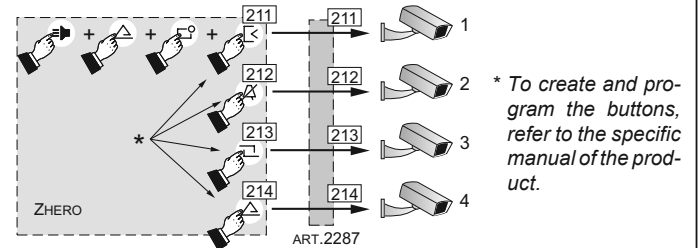
**xyz** To enter the name and address adjustment (for example: Cyclic 211), refer to the specific manual of the product.

## Individual operation

Press one button at a time to switch the outputs; by pressing a single button, the selector switches to the chosen output. From the videointercoms enable the requested service (e.g. enabling surveillance cameras) as per the following procedure:

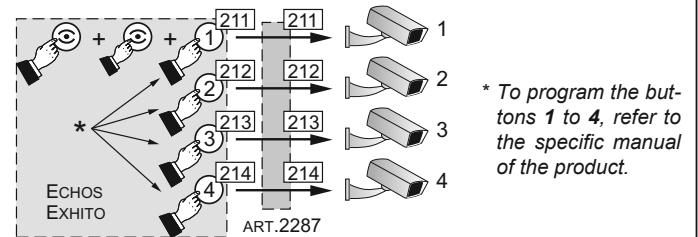
## a) Zhero series

- press to turn ON the videointercom;
- press (symbol on the screen ) to enter the advanced functions;
- press "monitor" to activate the input of the surveillance camera (terminals **M** and **V** of the push-button panel);
- press the button corresponding to the camera to be enabled.



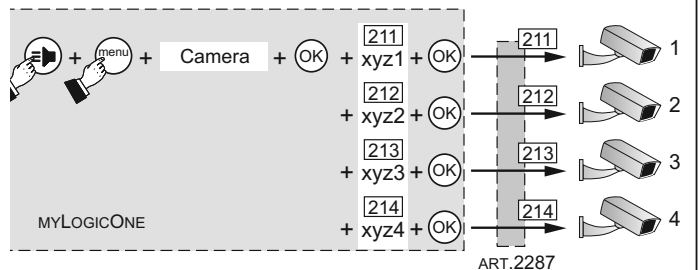
## b) Exhito (only EX3262) series

- press to turn on the videointercom;
- press again to activate the input of the surveillance camera (terminals **M** and **V** of the push-button panel);
- press the button corresponding to the camera to be enabled.



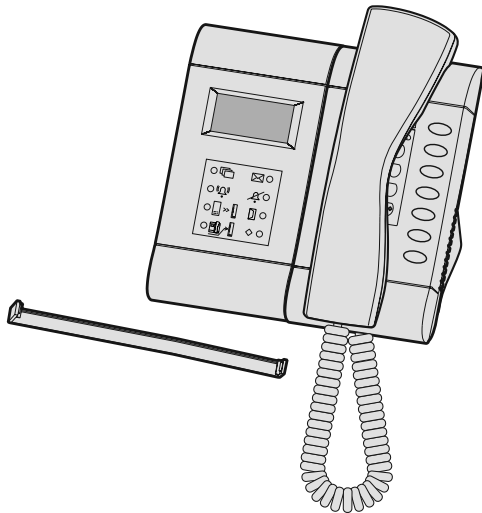
## c) myLogicOne series

- press to turn on the videointercom;
- press "menu" to display the list of services that can be activated;
- select "camera" for the activation of the surveillance camera (terminals **M** and **V** of the push-button panel) and press **OK**;
- select the **name** of the camera to be activated and press **OK**.



**xyz** To enter the name and for address (for example: Camera 1 - 211; Camera 2 - 212; etc.), refer to the manual of the product.

## DOORKEEPER EXCHANGER



**PDX2000.** Doorkeeper exchanger PDX2000 is a component of the Digital System "DUO" and comes with a table adaptor and junction box for an easy connection to the installation. Equipped with an alphanumerical keypad, an LCD display and 7 service buttons suitable for making all the functions. The doorkeeper exchanger can communicate with 200 users (intercoms or videointercoms) and with one or more door stations.

### Main functions

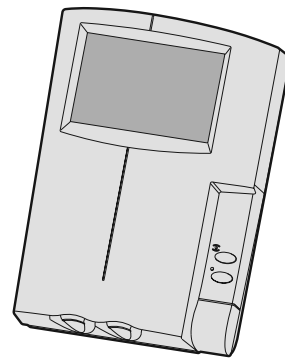
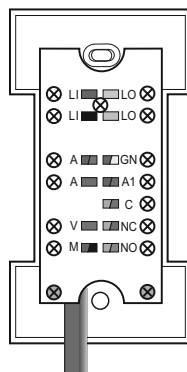
- Three operating modes: day, night and direct call
- Communication between internal users or internal users and door stations
- Monitor of one or more door stations
- Inclusion on a busy user
- Booking of calls (it can store up to 50 unanswered calls)
- Selective door lock release
- Users directory

### Technical data

Power supply directly from the line  
 Operating current:  
 Max: 0.5A  
 Stand by: 0.04A  
 OFF (night): 0.02A  
 Permanent memory for programming data  
 LCD Display: matrix points 64x128  
 LED's: 8  
 Alphanumerical keypad: 15 keys  
 Service buttons: 7  
 Internal relay: 1  
 Maximum load contacts relay: 12Vac/12÷24Vdc - 1A  
 Operating temperature: 0° ÷ +50°C  
 Maximum admissible humidity: 90%RH

### Terminal board

**LI / LI** Duo line inputs  
**LO / LO** Duo line outputs  
**A / A** Auxiliary power input (12-15Vdc - 0.5A)  
**C** Common contact of internal relay  
**NC** Normally open contact of internal relay  
**NO** Normally closed contact of internal relay  
**V** Video output for an auxiliary monitor (unbalanced 75Ω)  
**M** Video output ground  
**GN** Negative input for a local call  
**A1** Positive input for a local call



**ST7100CW.** White monitor with colour 4" LCD.

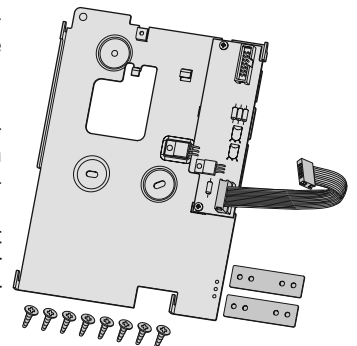
### Technical data

Power supply	12÷15Vdc
Operating current	0.5A
Monitor	4" LCD
TV standard	PAL
Bandwidth	>5MHz
Video signal on 75Ω	0.8÷1.5Vpp
Starting up time	1 sec.
Operating temperature	0°÷+50°C
Max. permissible humidity	90%RH

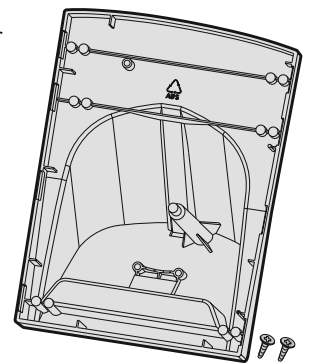
**WB7260.** Bracket to fix the monitor **ST7100CW** to the wall or to the table adaptor (art. **TA7100W**).

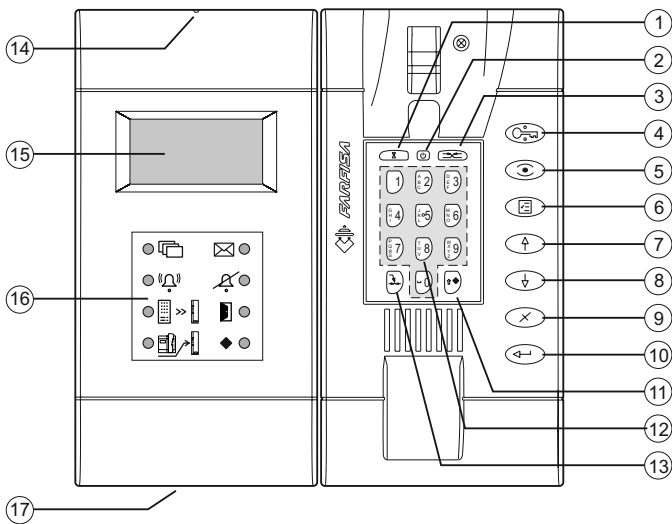
Complete with:

- flat cable for electrical connection of one videointercom **ST7100CW** to doorkeeper exchanger **PDX2000**.
- templates for correct alignment and fixing of the monitor **ST7100CW** to the doorkeeper exchanger **PDX2000**.



**TA7100W.** White Table adaptor for **ST7100CW** monitor.





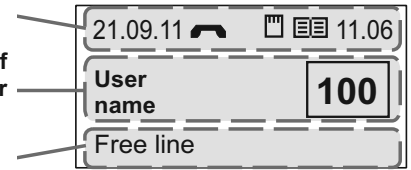
## CHARACTERISTICS

- 1 - Button “**hold**”. During the conversation with an internal user or a door station, pressing it, it is possible to hold the conversation in progress and then resume it by pressing again the same button. The user in hold is flashing on the display.
- 2 - Button “**ON-OFF**”. It allows to power ON and OFF the doorkeeper exchanger (function **day-night**).
- 3 - Button “**connect**”. It allows to put in communication 2 internal users or a door station with an internal user.
- 4 - Button “**door opener**”. It allows to release the lock of the door station in conversation in that moment or that of the last door station from which a call has been made.
- 5 - Button “**monitor**”. It allows to control a door station quickly connecting to it (or in case of multiple entrances. To the last door station from which a call has been made).
- 6 - Button “**menu**”. This is the button which allows to access all the functions to set and program the doorkeeper exchanger. To move inside the submenus use the arrow buttons.
- 7 - Arrow **up** (or **back**).
- 8 - Arrow **down** (or **forward**).
- 9 - Button “**erase**”. It allows to erase a character or a selection during settings or insertion of names.
- 10 - Button “**enter**”. It allows to confirm and proceed to the next entry.
- 11 - During the normal operations of the doorkeeper exchanger it allows to **actuate the internal relay**. During the insertion of data this button is used to select the **type of character** (upper or lower case, numbers, etc.).
- 12 - **Alphanumerical Keypad**.
- 13 - Button “**inclusion**”. It allows the doorkeeper exchanger operator to include during a communication in progress.
- 14 - Button “**reset**”. Press this button to restart the doorkeeper exchanger. During the reset no data will be lost.
- 15 - **LCD Display**. It shows data and functions during the operation of the doorkeeper exchanger or during the programming.
- 16 - **LED's** to underline the most important functions of the doorkeeper exchanger.
- 17 - **Memory card socket**. Using the memory card it will be possible to import or export data and update the software of the product with any newer versions downloaded from [www.farfisa.com](http://www.farfisa.com).

## Display

The display is organized into 3 different areas

- **Status bar**
- **Name and address of internal users and door stations**
- **Operating info**



## Status bar

It is shown in the upper part of the display and gives the following info (from left to right):

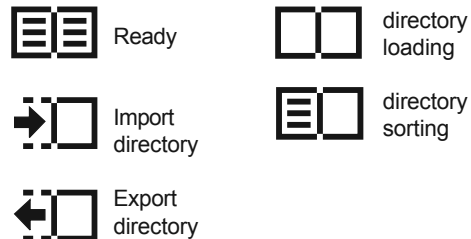
- **Date** (day-month-year)
- **Communication status** (see the following icons)

- Handset on hook
- Handset off hook
- Call to or from a user
- Communication in progress between doorkeeper exchanger operator and user or between two users
- Call from door station
- Communication in progress between doorkeeper exchanger operator and door station or between door station and internal user

- **Memory card inserted** (see the following icons)



- **Directory** (see the following icons)



- **Keypad locked**



- **Time** (hours-minutes)











**Attention.** All the **devices** connected to a DUO system, with the presence of a **PDX2000 doorkeeper exchanger**, must have a software release 400 or higher.



## SERVICE MODULES

### LED's

Under the display there are 8 LED's which indicate some important functions of the doorkeeper exchanger.

-  Shows that one or more bookings are present
-  Shows the presence of a message
-  Shows that a call is in progress (flashing)
-  Shows that the ringer tones of the doorkeeper exchanger have been excluded (minimum volume)
-  Shows that the direct call mode of the doorkeeper exchanger has been activated
-  Shows an opened door (if this function has been foreseen in the installation)
-  Shows that the "diverted to a user" operating mode of the doorkeeper exchanger has been activated (if supported by the software version)
-  Shows the activation of the internal relay in monostable or bistable operating modes

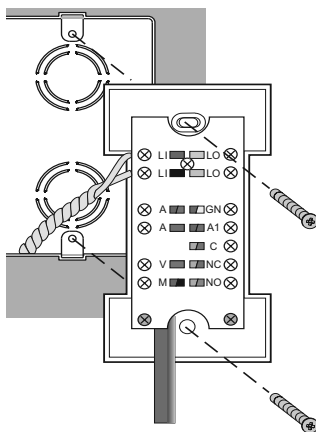
## INSTALLATION

The doorkeeper exchanger is ready for the installation on a desk.  
To fix the doorkeeper exchanger to the wall it is necessary to dismount the plastic table adaptors and use the same metal wall brackets. Do not use the junction box with the white connection cable and make the connections directly to the terminal board of the doorkeeper exchanger.

Fix the junction box to the wall with screws and expansion plugs or to a wall box (83mm) and make the connection according to the installation diagram.

Check for the correctness of the wiring.

Power-ON the system by connecting the power supplies to the mains.



## MOUNTING THE MONITOR ST7100CW SIDE BY SIDE THE DOORKEEPER EXCHANGER PDX2000

With the doorkeeper exchanger **PDX2000** it is possible also to get the image from door stations installing the monitor art. **ST7100CW**.

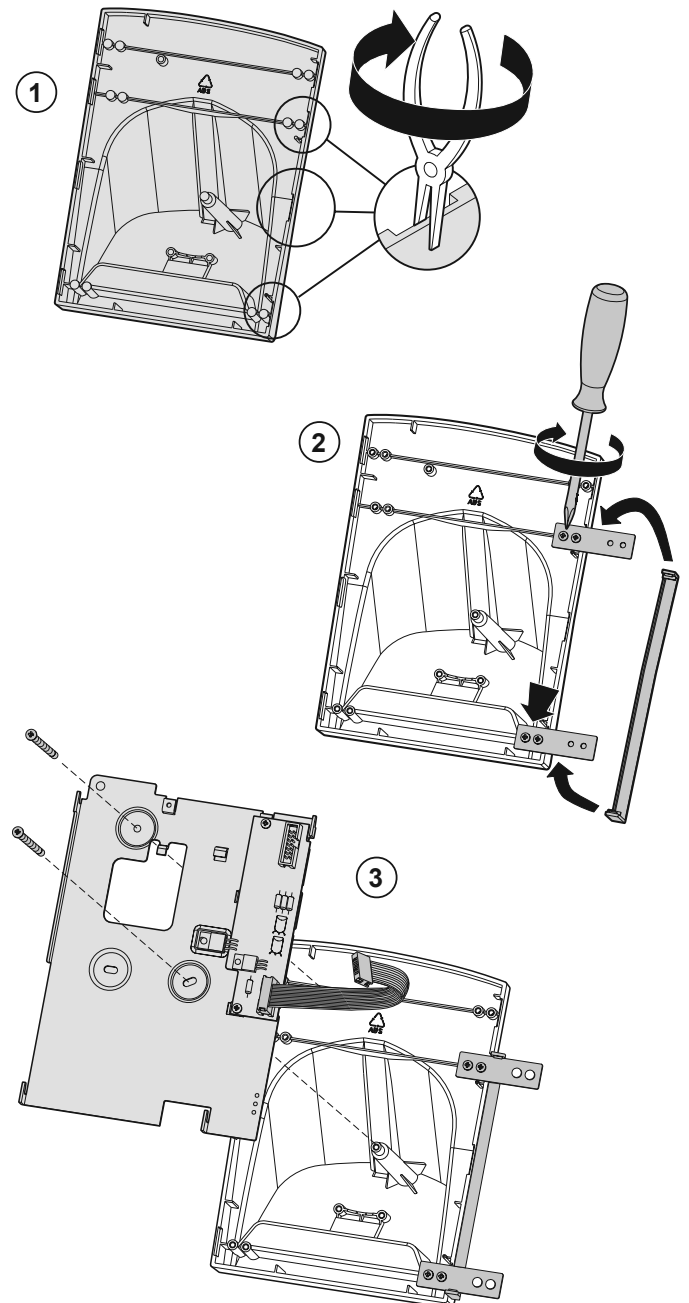
To install table add to the doorkeeper exchanger the following products:

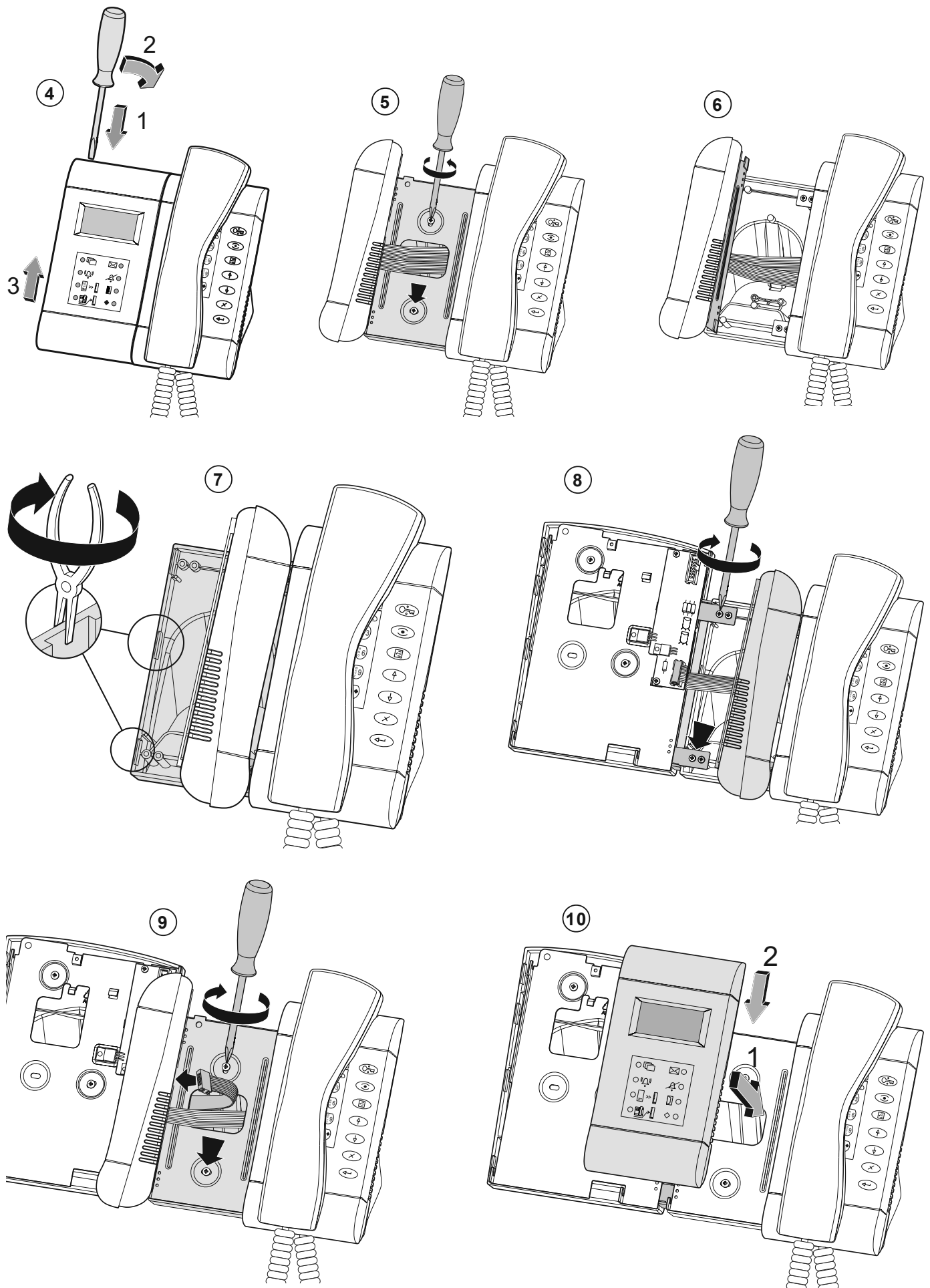
- 1 **ST7100CW** monitor
- 1 **WB7260** wall bracket
- 1 **TA7100W** table adaptor

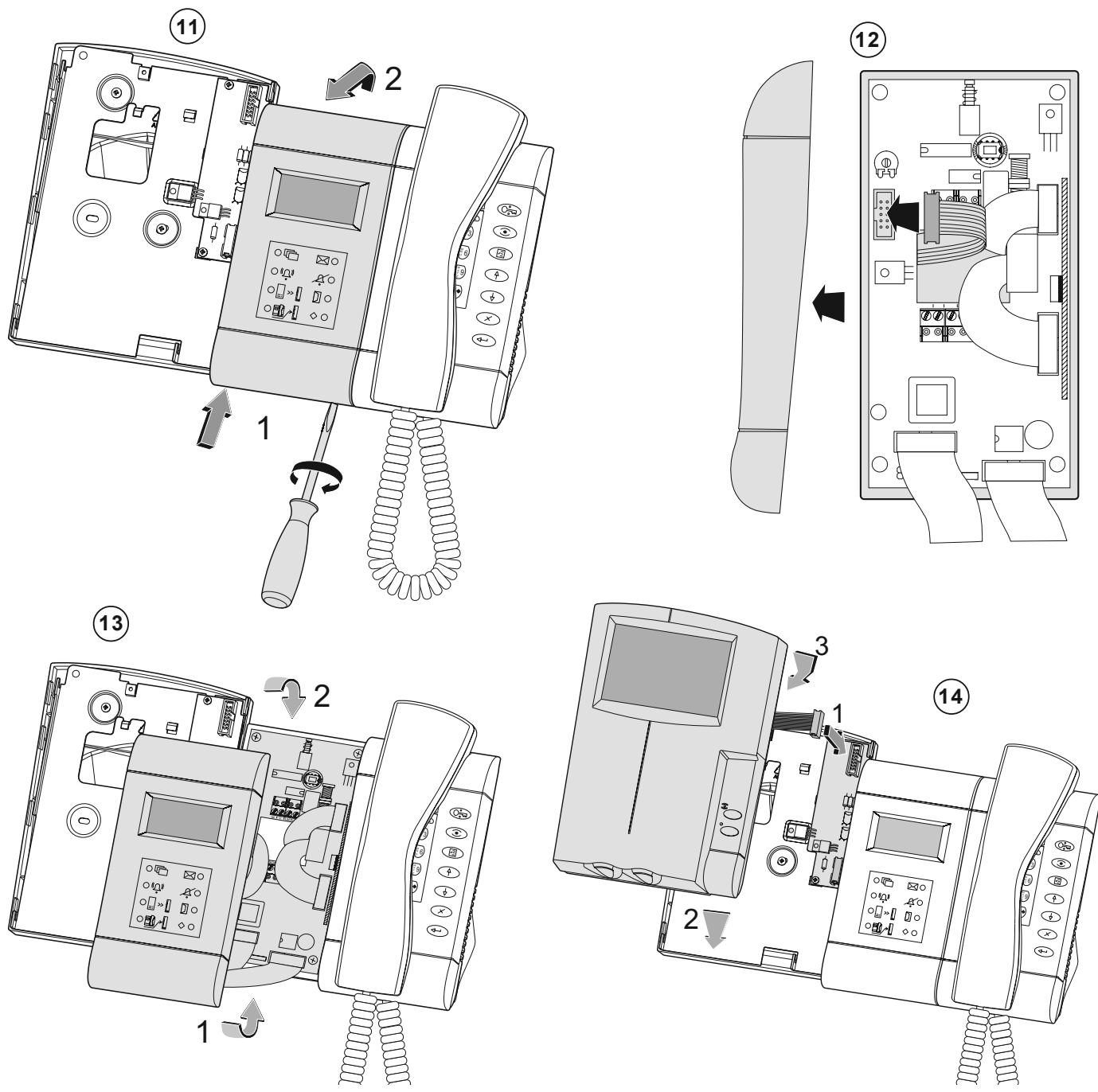
If the doorkeeper exchanger is installed on the wall, do not use the adapter TA7100W.



### Installation steps



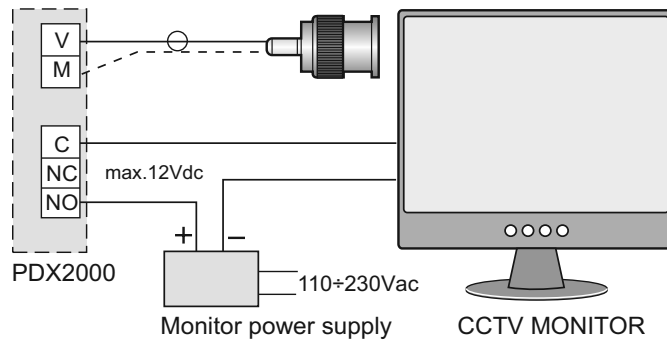




**Connection of a CCTV monitor**

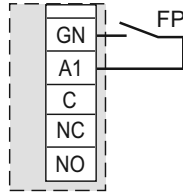
**Attention!** Please use a monitor with no earth connection (Class II) or use a ground loop separator. CCTV monitor can work either in continuous or timed mode. In the case of continuous mode (direct powering from the main) monitor is still powered-ON also when the door station is not connected (no image).

In timed mode monitor is powered-ON only when the door station is in connection (with image). To operate in this way it is necessary to connect the CCTV monitor as shown in the following diagram and program the internal relay of doorkeeper exchanger as reported in the chapter "Operating mode of internal relay" (see page 4.34).



## Connection of a local calling button (bell function)

Connecting a button (FP) between terminals A1 and GN it is possible to enable the doorkeeper exchanger ringing with a different ringing tone and without engaging the doorkeeper exchanger itself (only bell function).



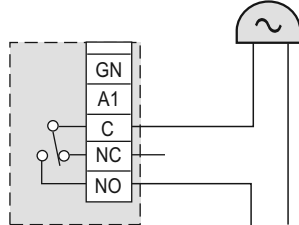
## Connection of a supplementary ringing bell or a lamp signaler for the incoming calls

By applying a self-powered ringer between terminals C and NO it is possible to drive to another room the calls received by the doorkeeper exchanger.

- Contacts C and NO of the relay are open in idle state and closed in activation mode.

- Contacts C and NC of the relay are closed in idle state and open in activation mode.

It is possible to program the ON time of the relay, acting in the proper submenu in the "advanced settings" menu.



## PROGRAMMING

For a correct operation of a digital system "DUO", it is necessary to program all the devices present in the installation.

- **Doorkeeper exchanger** is programmed from factory with the address 201. If it is necessary address can be changed following the instructions reported on the chapter "PDX Address" (see page 4.35).
- In all the **internal stations** a button, pressing which you will call the doorkeeper exchanger, must be programmed with the same address of doorkeeper exchanger (according to the previous example 201); follow the procedure for programming individual internal stations (see chapter 2).
- Program all the **door stations** to set them for the presence of the doorkeeper exchanger (see chapter 3 / 3A).

## Operating functions

The doorkeeper exchanger can operate in the following operating mode: OFF, ON and Direct Call.

### Doorkeeper exchanger OFF (night)

Doorkeeper exchanger is not operative while the other devices of the system still continue to work as intended. All the call directed to the doorkeeper exchanger will be lost.

### Doorkeeper exchanger ON (day)

All the call either originated by the door stations or by internal users are intercepted by the doorkeeper exchanger except those made by the secondary door stations which can be managed by a secondary doorkeeper exchanger (if present in the installation).

### Direct Call

Enabling this function all the call originated by the door stations are diverted directly to the internal users without being intercepted by the doorkeeper exchanger. Doorkeeper exchanger will handle only the **call from internal users** and is able to **manage bookings** and **make an inclusions** to a communication in progress.

## Operating instructions

### Power-OFF

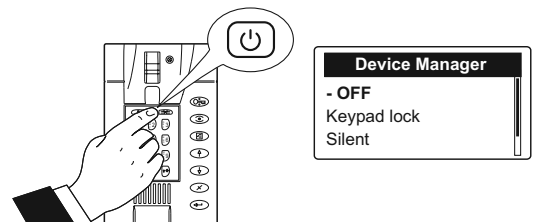
Keep pressed the button until the doorkeeper exchanger switches OFF or when the "device manager" menu appears select power "OFF" and then press . Already stored bookings will not be lost.

### Power-ON

Keep pressed the button for some seconds, the doorkeeper exchanger powers ON and starts to operate according to the previous settings.

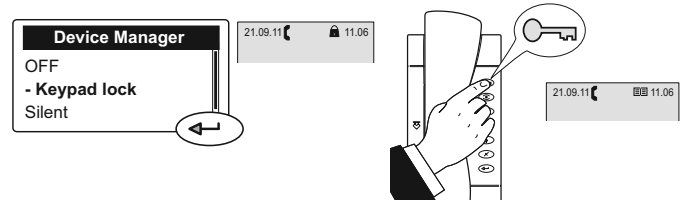
## Device manager

When the doorkeeper exchanger is ON, pressing shortly the button to display the "Device Manager" menu; in the menu are listed the following functions: Power-OFF, keypad lock, ringer tones OFF, ringer tones ON and software release.



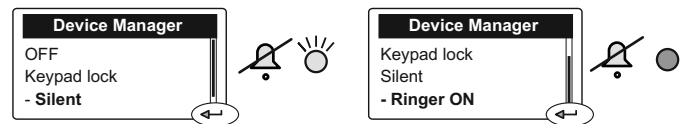
### Keypad lock

Activating this function, the keypad of the doorkeeper exchanger is locked, it is only possible answer to the incoming calls from door stations or internal users. In "Device Manager" menu select "keypad lock" and press ; on the display will appear . To unlock the keypad press for several seconds the button .



### Ringer tones OFF and ON

To set OFF (or ON) all the ringer tones of the doorkeeper exchanger it is necessary: - access the menu "Device Manager" by pressing shortly the button - select "Silent" - press ; LED will light-ON. To activate again the ringer tones select "Ringer ON" and press ; LED switches-OFF.



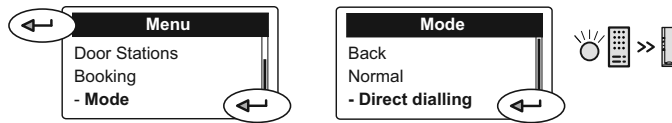
### Release Software

To display the software release of the doorkeeper exchanger select "release" and press . To exit this page press .

## Operating Modes

### Enable Direct Call

To enable the Direct Call function it is necessary: press - select "Mode" - press - select "Direct dialling" - press ; LED >> will light-ON showing that the Direct Call function has been activated.



**Note:** in case of power failure or switching-OFF the doorkeeper exchanger, the function **Direct Call** remains stored and will be activated again at the next power-ON.

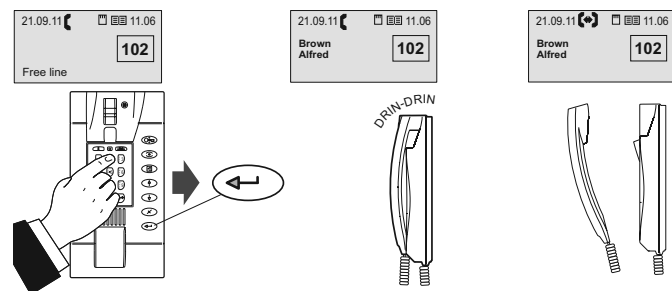
### Back to the operating mode "DAY"

To disable the Direct Call function and operate in "DAY" mode it is necessary: - press - select "Mode" - press - select "Normal" - press ; LED >> switches-OFF.

## OPERATION

### Make a call from doorkeeper exchanger

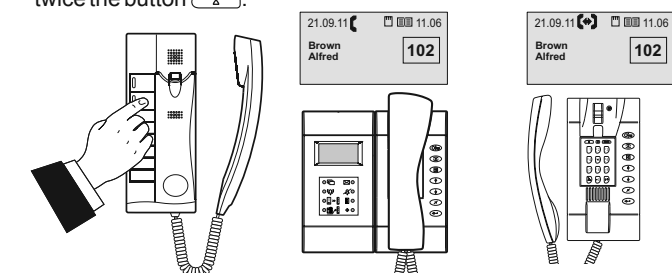
To make a call from the doorkeeper exchanger to an internal user it is necessary to dial the number of the required user using the keypad or select the name of the required user from the directory (see chapter "directory") and then press .



### Call the doorkeeper exchanger

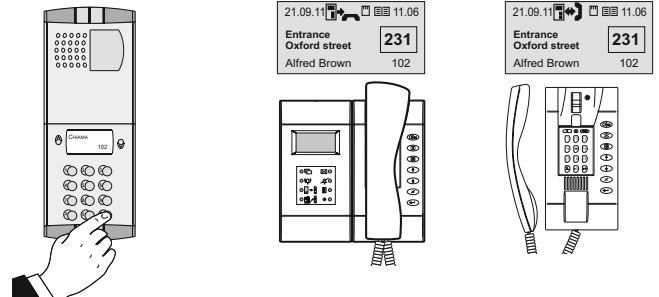
To call the doorkeeper exchanger from an internal station, it is necessary:

- pick-up the handset (or press in the models **Zhero**, **myLogic** and **Echos**);
  - if the line is free you will get a dialing tone
  - if the line is busy you will get a busy tone
- press the button on which the address of the doorkeeper exchanger has been stored
  - if, after about 30 seconds, doorkeeper exchanger operator does not answer or if it rejects the call, automatically the call will be stored in a booking queue
  - if the line is busy immediately the call is booked on the doorkeeper exchanger and an acoustic tone will be heard
  - if the line is free, doorkeeper exchanger starts ringing (see "select ringer and number of ringing" on page 4.34) its display shows the name and the address of the calling user; LED and light-ON.
- pick-up the doorkeeper exchanger handset within 30 seconds to answer the call. Communication time is about 90 seconds and during the last 10 seconds an acoustic tone will remind the communication time is going to expire; if some extra time is necessary press twice the button .



### Call from door station

Making a call from a door station, the doorkeeper exchanger will ring with the programmed ringer tone (see "select ringer and number of ringing" on page 4.34), the display will show the name and the address of the calling door station and of the user the caller is looking for; LED will light-ON indicating the incoming call. Pick-up the handset to talk with the door station, press the button to release the lock. Communication will last after 90 seconds or replacing the handset.

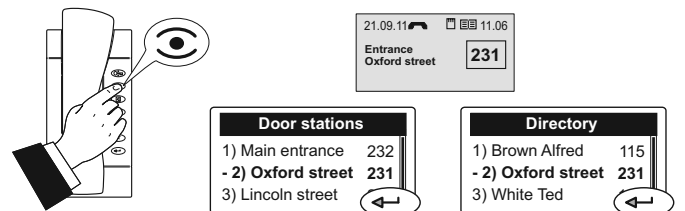


**Note.** If, when the door station makes a call, the doorkeeper exchanger is engaged in a communication with another user or there is a communication on "hold" or there is communication between two internal users, the doorkeeper exchanger will ring only with a single tone and LED lights-ON for all the time of the call. To communicate with the door station it is necessary to close all the communications in progress.

### Connection of the doorkeeper exchanger to the door stations

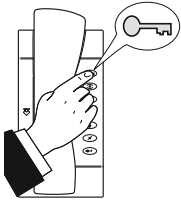
At any moment it is possible to monitor the door stations pressing the button . If in the installation there are more door stations, pressing the button the doorkeeper exchanger will be connected with the last door station which has made a call. For a **selective** connection with a specific door station it is necessary to operate as described in the following:

- pick-up the handset, dial the address of the door station you want to monitor (e.g.:231) and press to be connected only video with the door station (press or replace and pick-up again the handset to activate also the audio)
- pick-up the handset and dial the address of the door station you want to monitor (e.g.:231), press to be connected audio and video with the door station
- with the handset on-hook, select the requested door station from the **door stations** list. Press - select "Door stations" - press - select the requested door station from the list - press , you get only the video (to enable the audio pick-up the handset)
- with the handset on-hook select the door station from the **directory**. Press - select "Directory" - press - select the requested door station from the list - press , you get only the video (to enable the audio pick-up the handset).



### Door lock release

At any moment the lock of a door can be released by pressing the button . If more than one door is present in a system, pressing , you will release the lock of the door whose door station is actually in communication with the doorkeeper exchanger, or, if any communication is in progress, you will release the lock connected to the last door station which has made a call. To release selectively the lock, follow the same procedure described in the "Connection of the doorkeeper exchanger to the door stations" chapter and after getting audio and video communication (not only video) press the button and .



Door stations	
1) Main entrance	232
- 2) Oxford street	231
3) Lincoln	

Directory	
1) Brown Alfred	115
- 2) Oxford street	231
3) White Te	

## Hold state

While the doorkeeper exchanger is in communication with an internal user or a door station it is possible to hold the communication by pressing the button . The details of user or door station on hold will be transferred to the bottom of the display and flashing; the internal user or door station on hold will get an acoustic or visual signalling. To resume the communication, press again .

## Communication between two internal users

While the doorkeeper exchanger is in communication with an internal user it is possible to connect him with another internal user for a period of 60 seconds (which can not be extended) following the below procedure:

- press the button ; user actually in communication with the doorkeeper exchanger will be put on hold receiving a tone on the handset
- hold receiving a tone on the handset dial the address of the second internal user you want to call (or select him from the directory)
  - if the second user do not answer, press to resume the line or wait for 30 seconds the call will last; press to talk again with the first user on hold
  - if the second user answers, but does not wish to talk with the other user, wait the user replace the handset or press to close the call and get the line; press again to resume the first user on hold
  - if the second user answers and wishes to talk with the other user, press button ; on the display of the doorkeeper exchanger, until the communication lasts, appears the details of the two users in connection.

**Attention.** In some particular installations this feature can not be guaranteed for all the users.

To interrupt a communication between to users see chapter "Inclusion".

## External to Internal Communication

While the doorkeeper exchanger is in communication with a door station it is possible to transfer the call to an internal user for 60 seconds (which can be extended) following the below procedure:

- press the button ; door station actually in communication with the doorkeeper exchanger will be put on hold
  - if the address of the internal user which is displayed is correct press
  - if it is wrong press to erase it and dial the correct address (or select him from the directory)
  - if the called user do not answer, press to resume the line or wait for 30 seconds the call will last; press to talk again with the door station on hold
  - if the called user answers, but does not wish to talk with the person asking for him at the door station, wait the user replace the handset or press to close the call and get the line; press again to resume the door station on hold.
  - if the called user answers and wishes to talk with the person asking for him at the door station, press button ; on the display of the doorkeeper exchanger, until the communication lasts, appears the details of the door station and the internal user in connection.

To interrupt a communication between the door station and the internal user see chapter "Inclusion".

## Inclusion

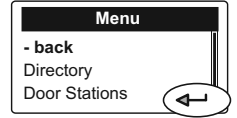
While a communication between two internal users or between a door station and an internal user is in progress the doorkeeper exchanger operator can include into the conversation by picking-up the handset and pressing the button . During the inclusion, a background tone will warning that a third person is listening.

To exit from the inclusion mode doorkeeper exchanger operator has to replace the handset.

To release the line doorkeeper exchanger operator can also interrupt the communication making first an inclusion (by pressing button ) than pressing again the button , selecting YES in the submenu which appears on the display and finally pressing .

## Menu

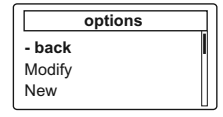
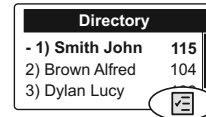
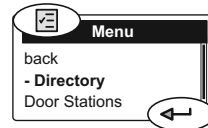
Pressing this button you will access to the settings, programming and operating modes of the doorkeeper exchanger: Directory, Door Stations, Booking, Operating modes and Settings. To access to the submenus uses the buttons and confirm by pressing .



## Directory

In the Directory can be stored up to 300 names of users or door stations with their addresses (e.g. Alfred Brown 104; Entrance Oxford St. 231). To access the directory it is necessary:

- press the button - select "directory" - press (all the names stored in the directory will be displayed in alphabetic order, or you get a blank page if any user has been previously stored) - press - you access the following functions: Modify, New, Delete, Sort by Name, Sort by address, List, Details, Export, Import.



**Note.** While entering or modifying a name it is possible to change the character's type by pressing the button .

## Entering names and addresses

To enter the user's names or the door station's identification names you can use either the alphanumeric keypad or a memory card (see chapter "Import/export of names" on page 4.33).

To enter the names by the keypad follow the below instructions:

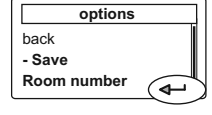
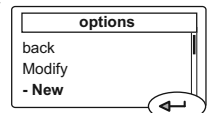
- after entered the directory menu as described previously select "New", press , enter the user's or door station's name (e.g. Alfred Brown) using the alphanumeric keypad; in case of typing error, place the cursor on the right of the wrong character and press to erase it;
- press to confirm e move to enter the user's address. **Attention:** the address to enter must correspond to the address stored into the device to be called (Mr. Alfred Brown's intercoms or videointercoms address e.g. 104)
- after having entered the user's address press , select "Save" and press to store the user into the directory.

To add other users to the directory repeat the previously described operations.

If it is necessary to store two users with the same address (wife and husband; professional office and apartment) it is sufficient to create two different users with different name but with the same address.

## Modify a user's name or user's address

- In the directory select the requested user - press - select "modify" - press - using the button place the cursor to the last character of the name to be modified - press several times to delete all the characters of the name - enter the new name - press - cursor automatically moves to the address box - press to erase the address - enter the correct address - press - cursor moves to a small box on which there is written the number "0" (do not change it;



## SERVICE MODULES

only in some specific cases it is possible to change this number) - press - select "Save" - press ; changing is automatically stored and you will be back to the directory list.

### Delete a user

In the directory select the user to be deleted - press - select "delete" - press - with the button select **Yes** - press ; user is automatically deleted and you will be back to the directory list.

### Sorting of user's names

Select the sorting you like ("by name" or "by address") than press you will be back to the directory list sorted according to your chose.

### Display of users

The users can be displayed like a list or one by one in details. Make the choice and press to be back to the directory. In both cases to move from one user to another you have to use the button and .

### Import/Export of users to/from the directory

To load in a quick way the directory it is possible to use a personal computer and a very common writing program like Block Notes, Word pad or similar. Users must be written in the following way:

"User's name and surname" followed by a "semicolon" (;) "blank space" and than "user's address" (3 figures) followed by a "semicolon" (;) "blank space" and than "room number" (normally write "0", only in some specific cases this number can be changed) followed by a "semicolon" (;), than press to insert another user.

E.g.: Alfred Brown; 104; 0;

Ted White; 110; 0;

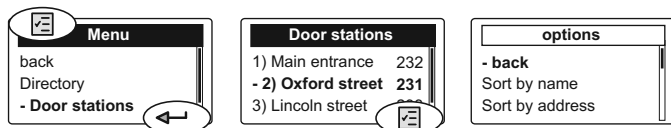
.....

Save the file into the memory card with the name: **contacts** (pay attention that doorkeeper exchanger recognizes only a file named **contacts.txt**; the name of the file must be written using only lower cases letters) – insert the card into the proper socket of the doorkeeper exchanger – open the directory menu – press - select "import" – on the display appears: "procedure in progress: please wait" and a loading bar will show the percentage of already loaded data. Once finished the loading procedure the system will go back to the directory. If the loading procedure doesn't start, please control for the presence in the memory card of the file: **contacts.txt** (written with lower cases letters and the extension .txt), please double check for the correctness of data written inside the file (see above example and take care that after the name and surname there is a **semicolon** as separator followed by a blank space than a 3 figures address, again a **semicolon** as separator followed by a blank space and 1 figure number than a **semicolon** as separator without any blank space. Very important is that for each user there must be exactly 3 **semicolon** as separators). Finally check that the program used to write the file will create a standard .txt file.

To download the directory to the memory card, select "export". Wait the end of downloading to remove the memory card from the socket. Doorkeeper exchanger will create in the memory card the file **contacts\_ddmmyyyy.txt**, were dd is the current day of the month, mm is the current month of the year and yyyy are the current year.

### Door stations

Selecting "**Door Stations**" and pressing you will access the list of door stations of the system (if previously stored in the directory). Press to access the submenu were it is possible to chose the sorting mode of the list (same procedure described in the chapter "directory" on page 4.32) or press to connect to the selected door station (as described in the chapter "Connection of the doorkeeper exchanger to the door stations" on page 4.31).



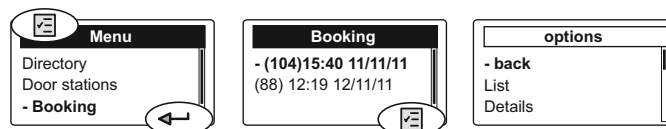
**Attention!** The list of door stations of the system is automatically created from the users stored in the directory. All the users with addresses from 231 to 250 will considered as door stations.

### Booking management

The presence of a booking queue in the doorkeeper exchanger is indicated by the flashing LED .

To display the booking list it is necessary:

- press the button - select "Booking" - press ; the booking list will be displayed with the details of the user's address, date and hour of calling;



- pick-up the handset and press to call the currently selected users from the booking list

- if the user doesn't answer he remains booked
- if the user answers the booking will be cancelled.

At the end of conversation replace the handset.

To cancel a booking without calling back the user it is necessary:

- select the user's name from the booking list - press - select "delete" - press - using the button select **"Yes"** - press .

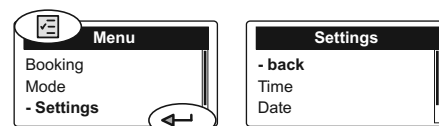
To exit the booking menu press the button - select "back" or "exit" - press .

### Operating Mode

You access the operating modes of doorkeeper exchanger ("day" or "direct calling"). See "Enable direct call" and "Back to the operating mode - day" on page 4.31.

### Settings

In this menu it is displayed the list of settings. Time, Date, Language, Ringing Tones, Ringing Volume, Backlighting, LCD Contrast and Advanced Settings.



#### Time

Select "Time" and press - with the keypad enter the actual hour - press - with the keypad enter the actual minutes - press - select "save" - press - the new time is stored and you will be back on the previous page.

10 : 44

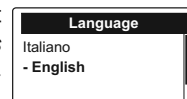
#### Date

- Select "Date" and press - with the keypad enter the actual day of the month - press - with the keypad enter the actual month of the year - press - with the keypad enter the two last figures of the actual year - press - select "save" - press - the new date is stored and you will be back on the previous page.

27 . 09 . 11

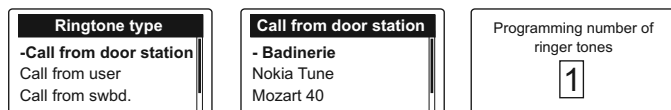
#### Language

- Select "Language" and press - from the list select the desired language (from the factory it is selected Italian) - press - select "save" - press - the new language is stored and you will be back on the previous page.



## Select ringer tones and number of ringing

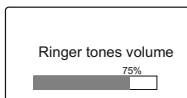
Doorkeeper exchanger can receive 4 different kinds of call (from door station, from user, from another doorkeeper exchanger and local call using a button connected between GN and A1). Operating in the following way it is possible to select a different ringing tone for each call: - select "Ringing Tones" and press - from the list select the kind of call which you want to change - press - you will hear the actual ringing tone, from the list select the desired ringing tone - press - you access a page on which is written the actual number of ringing, if you want to change it erase the actual number and enter, with the keypad, the new number (from 1 to 9) - press - select "save" - press .



## Ringing Volume

Ringing volume is the same for all the kind of calls.

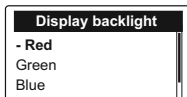
- To adjust it select "Volume" and press - an adjusting bar is displayed on the screen - with the buttons adjust the volume - press - select "save" - press .



Ringing Tones can be disabled choosing the lowest level of volume in this menu or directly from the Device Manager menu. Ringing volume can be also momentarily adjusted acting on the buttons while receiving a call.

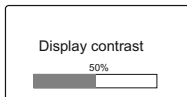
## Display Backlighting

Select LCD Backlighting - press - chose the desired color from the list or create a new color - press - select "save" - press .



## Display Contrast

Select LCD Contrast - press - an adjusting bar is displayed on the screen, adjust the contrast of LCD acting on the buttons - press - select "save" - press .



## Advanced and System settings

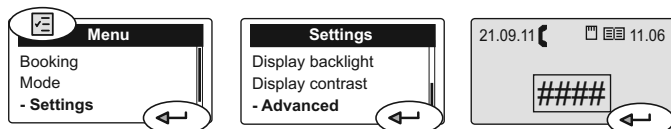
Advanced and system settings are **fundamental** for the correct working of the system, therefore they are accessible only entering a 4-digit password. From the factory the **password is 1234**. It is advisable to change it with a personal one (see chapter "Password changing" on page 4.34).

**Attention.** It is advisable to write down the new password and keep it in a safe place; If you lose the password you must ask a new one directly to ACI FARFISA.

## Advanced

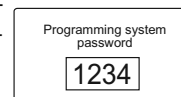
To access the advanced menu you should:

Press - select "settings" - press - select "advanced" - press - enter the 4-digit password - press - the following functions will be listed: Password, Relay mode, Relay timing, Restore factory settings, Clear all bookings, Delete list, Recovery Directory.



## Changing Password

To change the password it is necessary: - select "Password" - press - press to erase the actual password - enter the new 4-digit password - press - select "save" - press .

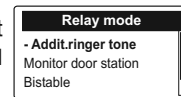


## Operating mode of the internal relay.

Relay inside the doorkeeper exchanger (terminal boards C, NC, NO) can be used for:

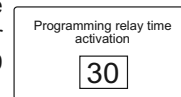
- **additional ringer** for the incoming calls, a lamp signaller can also be driven
- **power-ON a CCTV monitor** only during the calls from the door stations
- **bistable relay** operated by the button ; when the relay is activated the LED will light-Up
- **monostable relay** operated by the button ; when the relay is activated the LED will light-Up, timing of relay should be set according the instructions of chapter "Timing of internal relay".
- **remain activated** when the doorkeeper exchanger is switched to night mode.

To set the operating mode it is necessary: - select "Relay mode" - press - select the requested mode - press - select "save" - press .



## Timing of internal relay

To set the activation time of relay, only when the relay operates as "additional ringer tone" and "monostable", it is necessary: - select "Relay timing" - press - press to erase the previous programmed activation time - enter the new activation time in seconds (from 1sec to 99 sec.) - press - select "save" - press .



## Others

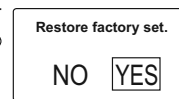
**To operate these functions the assistance of a Farfisa technician is necessary.**

- Save DUO Logs
- LED x debug
- Video always ON

## Factory settings

To restore the factory settings and reset all the data previously programmed (except the directory) it is necessary:

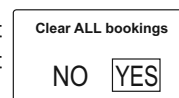
-select "Restore factory settings" - press - select **YES** to confirm or **NO** to exit - press - select "save" - press .



## Clear all bookings

To cancel all the booking queue:

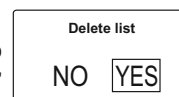
-select "Clear all bookings" - press - select **YES** to confirm or **NO** to exit - press - select "save" - press .



## Erasing completely the directory

To completely erase the directory:

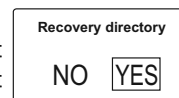
-select "Delete list" - press - select **YES** to confirm or **NO** to exit - press - select "save" - press .



## Restoring the users' in the directory

To restore the last erased directory:

-select "Recovery directory" - press - select **YES** to confirm or **NO** to exit - press - select "save" - press .

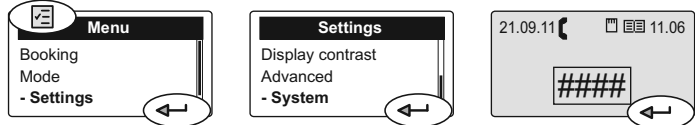




## System

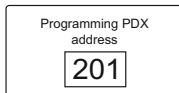
**Attention.** In this submenu there are some parameters whose changing can affect the correct operation of the system. It is necessary to modify these parameters only if in the system there is more than one doorkeeper exchanger. If in the system there is only one doorkeeper exchanger do not modify any parameter. To access this submenu it is necessary:

- press - select "settings" - press - select "system" - press
- enter the 4-digit password - press - the following functions will be listed: PDX address, PDX hierarchy, PDX type.



### PDX address

To change the PDX address, it is necessary: select "PDX address" - press - press to erase the previous address of the doorkeeper exchanger (from the factory 201) - enter the 3-digit new address (allowed addresses from 201 to 210) - press - select "save" - press .

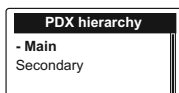


**Attention.** Internal users must have on their intercom or videointercom a button coded with the same address of the doorkeeper exchanger.

### PDX Hierarchy

If in an installation there is one or more doorkeeper exchangers on the main line and other doorkeeper exchangers in one or more secondary lines it is necessary to set each of them according to the following instructions:

- set as "Main" those connected to the main line
- set as "Secondary" those connected to the secondary lines

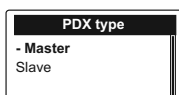


From the factory all the doorkeeper exchangers are set as "Main". Once in the PDX hierarchy menu - press - select "Main or Secondary" - press - select "save" - press .

### PDX type

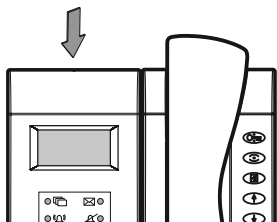
If in an installation there are more doorkeeper exchangers at the same hierarchical level it is necessary to set one of them as "Master" and the others as "Slaves" (for secondary doorkeeper exchangers this setting is required only for those connected to the same secondary line; more doorkeeper exchangers connected to a different secondary lines doesn't require to be set as "Master" and "Slave", on the contrary all of them must be set as "Master"). From the factory all the doorkeeper exchangers are set as "Master".

Once in the PDX Type menu - press - select "Master or Slave" - press - select "save" - press .



### Reset

Reset button is placed on the top of doorkeeper exchanger and can be operated only with a small stylus. To reset the doorkeeper exchanger keep pressed it for some seconds (avoiding to make an excessive strength), the doorkeeper exchanger will reboot soon without losing any data.



### Software updating

By means of the memory card it is possible to load in the doorkeeper exchanger memory new software releases which can be downloaded from the web site [www.farfisa.com](http://www.farfisa.com).

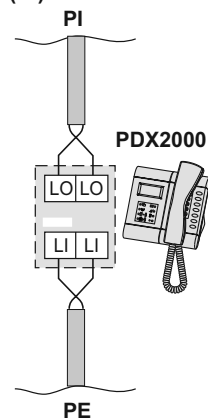
To upgrade the software release act as in the following:

- load the new software release into a memory card;
- insert the memory card in the proper socket located on the bottom of doorkeeper exchanger;
- press reset button (use a suitable stylus and do not make an excessive strength). Doorkeeper exchanger will reboot loading the new software version in a few seconds without losing any data or settings previously stored.

## Examples of the doorkeeper exchanger connections

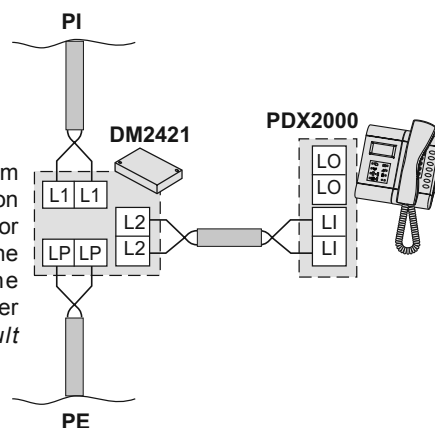
In every installation diagram the most suitable points for connecting the doorkeeper exchanger are marked with a diamond. The number inside indicates the usable types of connection from those shown in this section.

- 1 The in/out connection on the doorkeeper exchanger from the door station (PE) and the internal line (PI).



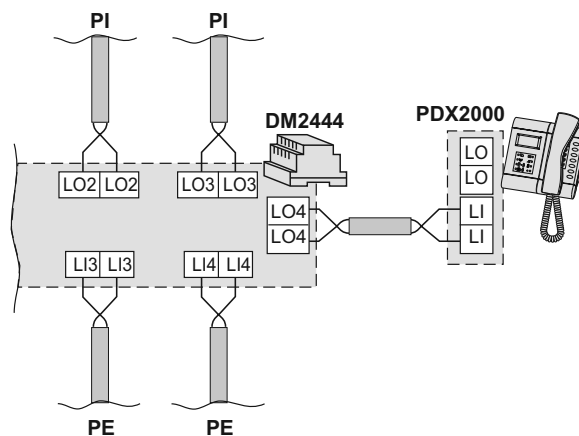
**Attention!** Remove the impedance between the 2 terminals LO in the junction box of doorkeeper exchanger.

- 2 The doorkeeper exchanger connection from the door station (PE) and the internal lines (PI) through the DM2421 distributor-switcher.



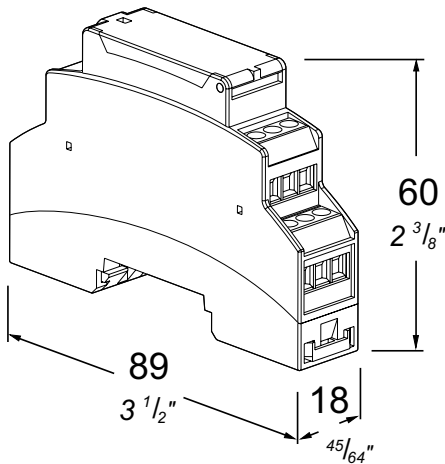
**Attention!** Program only the F1 interval on the DM2421 distributor line L2 inserting the address of the PDX2000 doorkeeper exchanger (default 201).

- 3 Connection of the doorkeeper exchanger to one of the DM2444 riser distributor outputs.



**Attention!** Program the DM2444 distributor LO4 output inserting the address of the PDX2000 doorkeeper exchanger (default 201). The other DM2444 inputs and outputs must be programmed following the indications on the installation schematic.

## ACTUATOR



**2281Q**, The actuator art.2281Q, designed for the DUO system, allows the activation of home automation functions or auxiliary services, such as extra locks, stair lights and ringer amplifiers without adding wires to the installed line. It is equipped with a **Relay and an Input Port** with which it is possible to acquire information about the status of a device connected to it, typically one contact (switch, device for end of stroke, etc.). The information acquired can be transmitted to the other devices in the system.

It is possible to connect more than one actuator to the same system, by correctly programming the relay and the input port addresses of each individual actuator; it is also possible to set the relay activation time between 0 and 99 seconds, the activation time also sets the operating mode of the relay, the relay can actually behave like a device:

- **monostable (activation time from 1 to 99 sec.)**. On receiving the command, the relay is activated for the programmed time and then turns off;
- **bistable (activation time 0 sec.)**. On receiving the command, the relay changes its status from active to inactive or vice versa until it receives the next command, following which the relay changes its status again.

### Technical data

Power supply:	from DUO line
Current	
stand-by:	0.01A
operating:	0,04A
Operating temperature:	0° ÷ +50°C
Maximum permitted humidity:	90% RH
Housing:	1 DIN module A

### Terminals

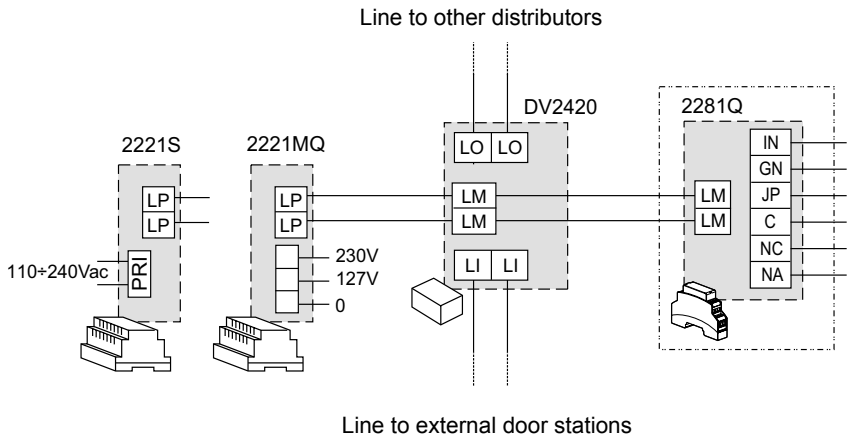
<b>LM/LM</b>	DUO Line
<b>IN</b>	Input Port
<b>GN</b>	Ground
<b>JP</b>	Program enabling
<b>C</b>	Relay common contact
<b>NA</b>	Relay normally open contact
<b>NC</b>	Relay normally closed contact

**Rating of relay contacts:** 240Vac - 1A

## INSTALLATION

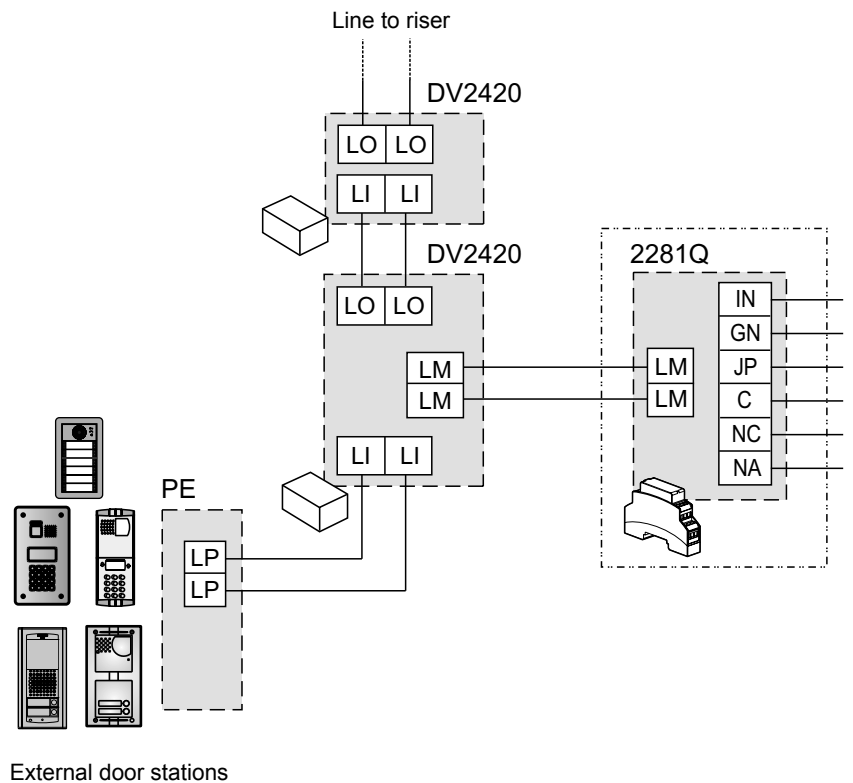
Some examples of possible applications are shown below.

**Connecting the actuator to the distributor DV2420 of the installation.**



**Connecting the actuator to an additional distributor DV2420.**

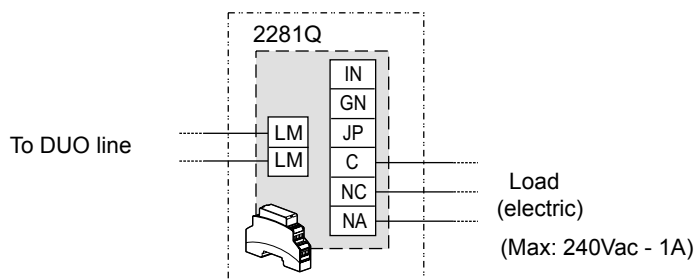
When there is the need to connect the actuator near to the external unit or along the line of one of the external units, you must add a DV2420 as shown in the following example.



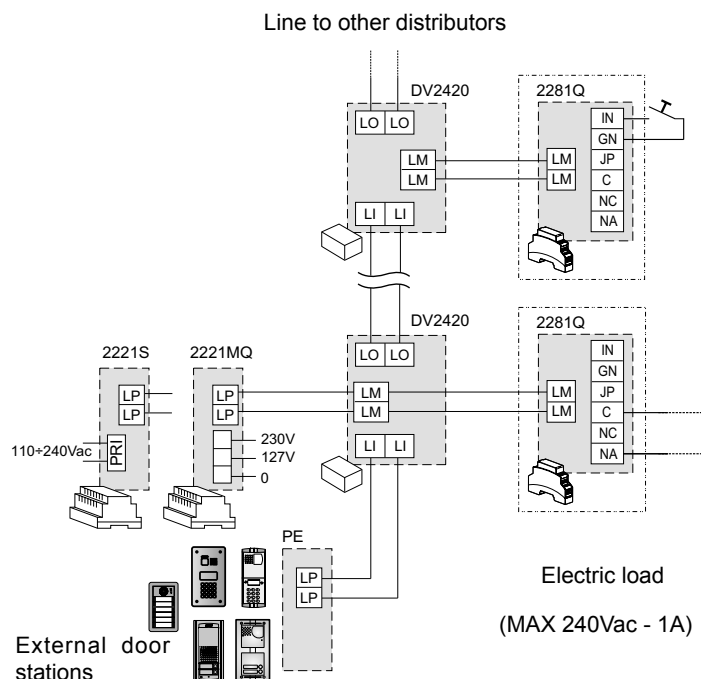
## SERVICE MODULES

### Output connections of an actuator:

- In stand-by the relay C and NA contacts are open; they are closed when the actuator is activated.



**Connection of 2 actuators connected on the same riser line: the first with input command (i.e.: a button) and the second with output switching (i.e.: connection of a relay to actuate staircase lights, electrical door locks, etc.)**



**Attention:** The actuators must be correctly programmed (see paragraph Activation from another actuator).

## OPERATION

### Activation of the actuator from internal units

The direct activation of the relay is always permitted by the internal unit which is in call, from the other internal units, the relay can only be activated at rest (no on-going call); with some devices and some system configurations, the relay activation can also take place in different situations (for information contact Farfisa customer service).

To activate the relay, it is necessary:

#### - from intercom/video intercom with handset

- to pick up the handset;
- verify that the system is free;
- press the pre-programmed button with the address of the relay to be activated, on the handset you will hear a 1 second confirmation sound;

#### - from hands free intercom/video intercom

- press the pre-programmed button with the address of the relay to be activated;
- if the system is free you will hear a 1-second confirmation sound;
- if the system is busy, you will hear a 1-second alert sound, in this case you should wait until the system is free and then press the button again.


### Activating the actuator from door stations

To activate the relay from door stations, after you have enabled this option in the actuator operating modes (code 2 or 6 depending on whether the actuator is defined as primary or secondary), it is sufficient:

#### - from the push-button panel with encoder

- to press the button with the stored address of the relay to be activated;

#### - from digital push-button panel

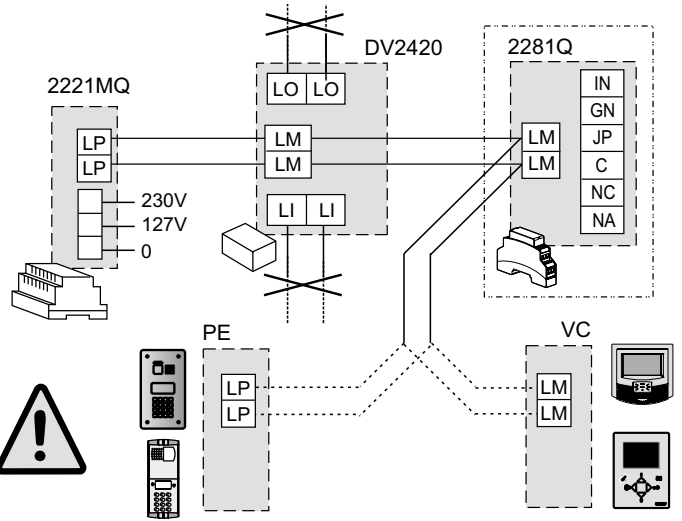
- to enter the relay address to be activated and press the button .

### Activation from another actuator

It is possible to activate the relay of a first actuator by pressing a button connected to the input port of a second actuator (terminals IN and GN). To perform this operation you must program the address of the input port of the second actuator, that is connected to the button, with the address of the relay to be activated. After pressing the button connected to the second actuator, the relay of the first actuator is activated according to the mode and time programmed for it.

## PROGRAMMING

For programming it is necessary that, in the system line where the actuator is connected, there is only one external unit or an internal unit with which to send the programming code (programming codes are equivalent to the addresses); **directly connect the external unit or the internal unit, with which you intend to program the actuator, to the terminals of the latter and disconnect the rest of the line as shown in the following figure.**



If you connect an external unit, some codes (231-255) can not be programmed because the device can not consist of such addresses.

Programmings that can be performed are:

### RELAY PARAMETERS

- 1. Address**  
Address with which the relay is identified within a DUO installation (factory setting 211, permitted values 211-220).
- 2. Activation time**  
Time in seconds that the relay is activated, **the value 0 sets the relay to bistable operation** (factory setting 1 second, permitted values 0-99 seconds).
- 3. Operational mode**  
Each value defines an operational mode of the relay as shown in Table 1 (factory setting code 0, permitted values 0-2-4-6). Example: the relaunch ringtone in an apartment where it is present an internal station already requires operating mode 6 (can be activated from external stations and at the same time is a slave device).
- 4. Additional address**  
Additional address by which the actuator can be identified within an installation (factory setting no value, permitted values 211-220).

**Table 1. Codes for the Relay operating modes**

Code	0	2	4	6
activation from external door stations		✓		✓
master device	✓	✓		
slave device			✓	✓

### INPUT PORT PARAMETERS

- 1. Address**  
Address with which the input port is identified within a DUO installation; (factory setting 221, permitted values 221-230).
- 2. Command transmitted by the device**  
Select the command transmitted by the device at the opening/closing of the IN-GN contacts as shown in Table 2; (factory setting code 0, permitted values 0-1-4).
- 3. Destination address of the command**  
Address of the device to which transmit the command; (factory setting no value, permitted values 1-250).

**Table 2. Codes for selecting the command transmitted by the device at the closing of the IN-GN contacts**

Code	0	1	4
Warning for open/closed door*	✓		
Lock activation of the external unit with address equal to the command destination address		✓	
Floor call to the internal unit with address equal to the command destination address			✓

(\* ) Warning command is transmitted to all the devices therefore it is not necessary to program the destination address.

## Access programming

- To access "relay" programming it is necessary to jumper terminal **JP** with **GN**;



(the red LED flashes quickly).

- To access "input port" programming it is necessary to jumper terminal **JP** with **IN**;



(the red LED flashes quickly).

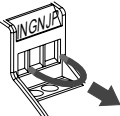
## Exit programming

- To exit the "relay" programming it is necessary to remove the jumper between terminal **JP** and **GN**;



(the red LED returns to flashing slowly).

- To exit the "input port" programming it is necessary to remove the jumper between terminal **JP** and **IN**;



(the red LED returns to flashing slowly).



**Attention:** programming must be carried out in sequence from number **1** to number **4** for the **relay** and from **1** to number **3** for the **input port**, only if, after performing a programming, the following are not required, you can exit this mode by performing the procedure "exit programming".

For example, if the intention is to program the relay address, you must:

- access programming;
- program the new address, the device acquires the value and prepares itself for the programming of the activation time;
- with no additional programming requested, you can exit the programming.

If you want to program the operating mode of the relay you must:

- access programming;
- program the relay address (even if the value already programmed is correct), the device acquires the value and prepares itself for the programming of the activation time;
- program the relay activation time (even if the value already programmed is correct), the device acquires the value and prepares itself for the programming of the operating mode;
- program the required operating mode, the device acquires the value and prepares itself for the second relay address programming;
- with no programming of this parameter requested, you can exit the programming.

## Programming the relay parameters

- Enter relay parameter programming as described in the section "access programming";
- The device is set to receive the relay address;
- from the external unit or from the internal unit (after having properly programmed a button) make a call to the address that corresponds to the address you wish to program (**between 211 and 220**). You will hear a confirmation sound and the device is ready for programming the activation time;
- exit if no further programming is needed, or from the external unit or internal unit (after having correctly programmed a button) make a call to the address that corresponds to the desired activation time (**between 0 and 99 seconds; the 0 code sets the relay in bistable operation**). You will hear a confirmation sound and the device is ready for programming the operating mode;
- exit if no further programming is needed, or from the external unit or internal unit (after having correctly programmed a button) make a call to the address that corresponds to the desired mode code (**0, 2, 4, 6**; for the meanings of the codes see Table 1). You will hear a confirmation sound and the device is ready for programming the second relay address;
- exit if no further programming is needed, or from the external unit or internal unit (after having correctly programmed a button) make a call to the address corresponding to the second address you want to assign to the relay (**between 211 and 220**). You will hear a confirmation sound and the device is ready to exit the programming;
- Programming is completed so you must exit the programming by performing the appropriate procedure. If you made a mistake, enter again the programming mode and start over with the programming of the relay parameters.

## Programming of the input port parameters

- Enter input port parameter programming as described in section "access programming";
- The device is set to receive the address of the input port;
- from the external unit or internal unit (after having correctly programmed a button) make a call to the address that you want to assign to the input port (**between 221 and 230**). You will hear a confirmation sound and the device is ready for programming the command transmitted by the device;
- exit if no further programming is needed, or from the external unit or internal unit (after having correctly programmed a button) make a call to the address that corresponds to the code of the desired command (**0, 1, 4**; for the meanings of the codes see Table 2). You will hear a confirmation sound and the device is ready for programming the destination address of the command;
- exit if no further programming is needed, or from the external unit or internal unit (after having correctly programmed a button) make a call to the address that corresponds to the destination address of the command to be programmed (**between 1 and 250**).

You will hear a confirmation sound and the device is ready to exit the programming. For the "**Door open/closed warning**", it is not necessary to program any destination address because it is a command which is transmitted to all devices.

- Programming is completed so you must exit the programming by performing the appropriate procedure. If you made a mistake, enter again the programming mode and start over with the programming of the input port parameters.

## Returning to factory settings (default)

To return the actuator to the factory settings and therefore delete all the modifications made during the programming phase, you must:

- enter the relay or input port programming as described in section "access programming";
- **to return to the factory values of all relay parameters**, program the address of the relay to the value **211**;
- **to return to the factory values all input port parameters**, program the address of the input port to the value **221**;
- exit programming.

## Integration in the system with DUO technology

In order to use the relay effectively you need to save in the button of internal units (intercom or video intercom) from which you want to activate the service, the same address assigned to the relay (for the programming see the instructions of the internal unit used).

# SERVICE MODULES

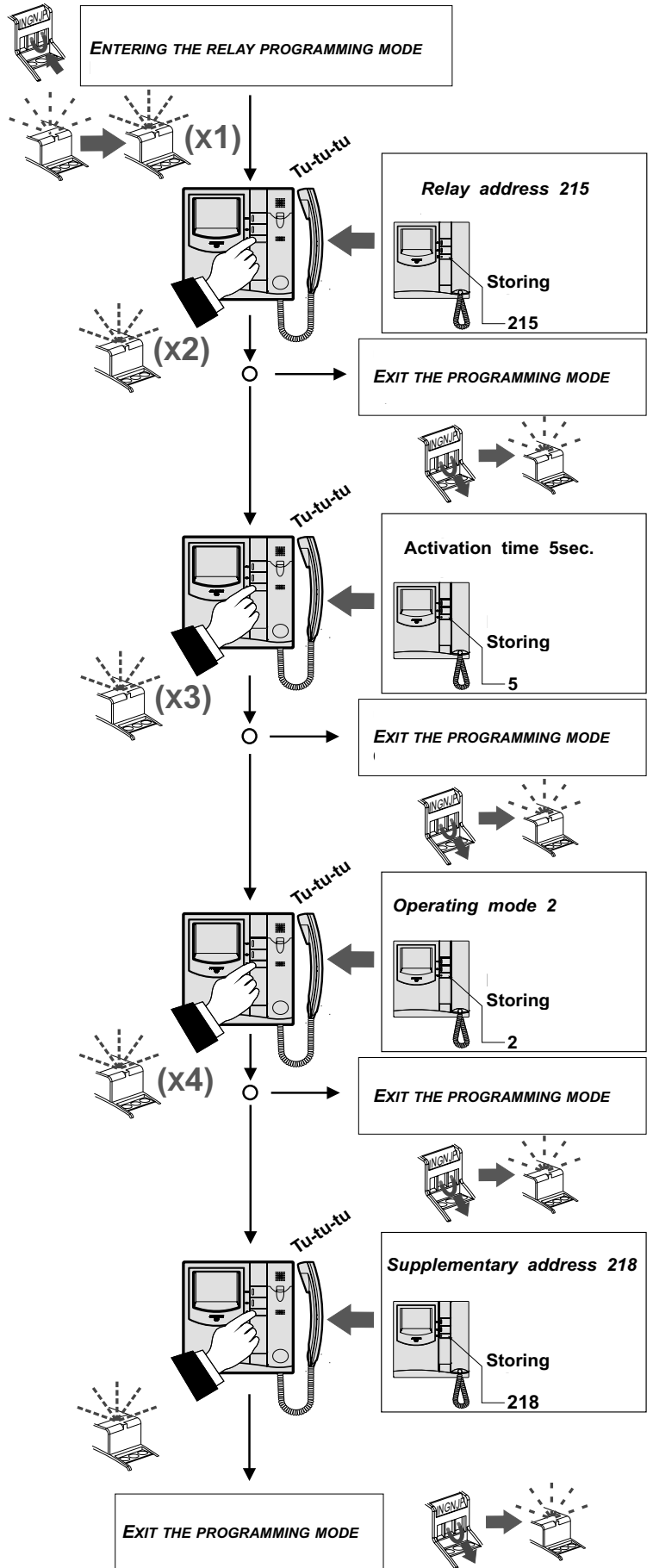
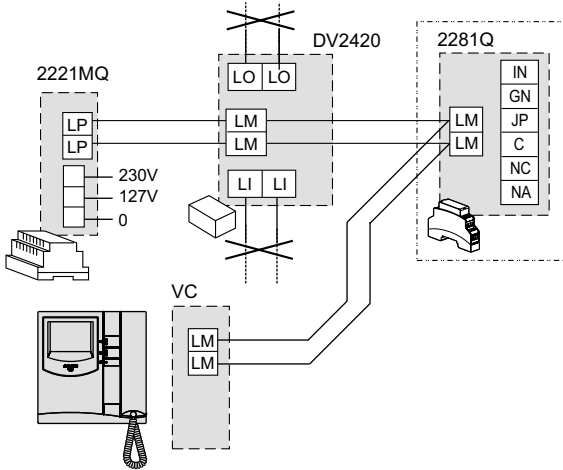
Example of programming a relay of an actuator using a videointercom:

Address: 215

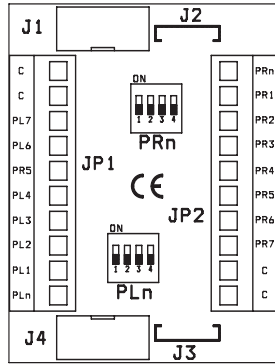
Activation time: 5 seconds

Operation mode: relay activated from external units being a main device (code 2)

Additional address: 218



## ENCODING BOARD



**XT2928U.** By connecting the calling buttons of an analog push-button panel to the input terminals of the device, it is possible to send coded calls to Farfisa digital systems.

### Terminals

**C** common input of buttons.

**PL7-PLn** input for left-side calling buttons.

**PRn-PR7** input for right-side calling buttons.

### Connectors

**J1-J2-J4** connection to Farfisa digital systems.

## INSTALLATION

- Connect calling buttons to the input terminals of the board XT2928U as shown in fig.3a - 3b.
- Using the supplied cables, connect the board XT2928U to a Farfisa digital encoding module (use J1 or J2 according to the connector of the Farfisa encoding module; fig.1a or fig.1b).
- Connect an eventual second board to the first using the connector J4 of the first board and J1 of the second one (fig.2).
- Connect in a similar way the eventual other boards XT2928U if present in the system (fig.2).

## PROGRAMMING

By setting the micro-switches PRn and PLn, it is possible to codify respectively the calling buttons connected to the input right-side terminals (PRn-PR7) and those connected to the left-side input terminals (PL7-PLn); the value on the micro-switches sets the value of the first calling button (PRn or PLn) as shown in the table on the next page, the other buttons will get the 7 sequential values (e.g. by moving to **ON the switch 3 and leaving to OFF switches 1, 2 and 4** of micro-switches **PRn**, the calling buttons **PRn-PR7** will get respectively the values **32, 33, 34, 35, 36, 37, 38 and 39**).



### Warning

- To know the address of the user called by pressing the button, refers to the technical manual of the digital encoder to which board XT2928U is connected.

- When the micro-switches are set to **n=0** (values of buttons 0-7), the first button (**PRn or PLn**) won't call any user because the Farfisa digital encoders doesn't accept the **0 (zero)** value.

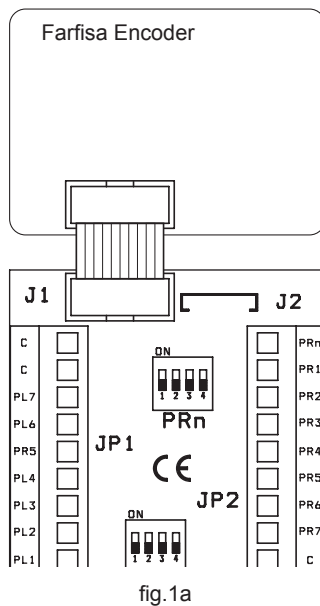


fig.1a

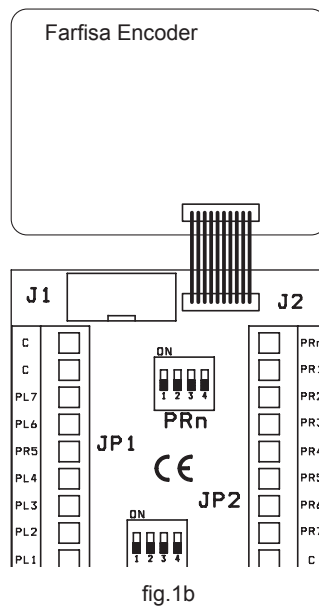


fig.1b

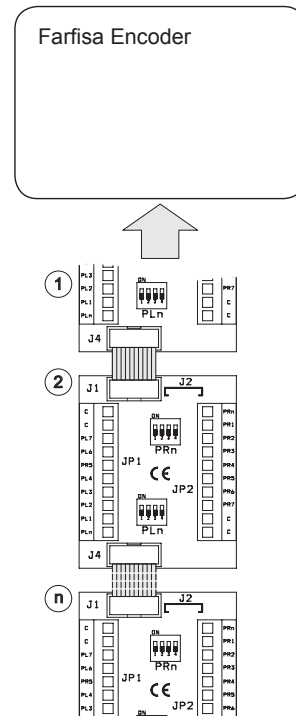


fig. 2

# SERVICE MODULES

Connection of calling buttons and position of micro-switches for coding the left-side push-buttons (PLn-PL7).

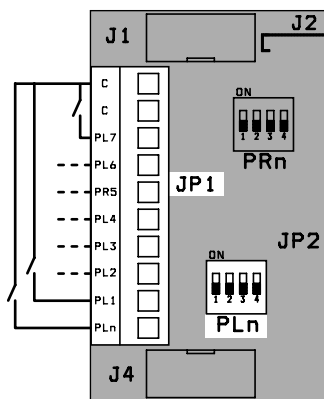


fig.3a

Connection of calling buttons and position of micro-switches for coding the right-side push-buttons (PRn-PR7).

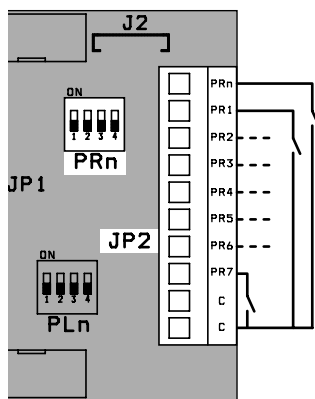


fig.3b

Position of micro-switches      Values of buttons

PRn      PRn ÷ PR7  
PLn      PLn ÷ PL7



0 ÷ 7



8 ÷ 15



16 ÷ 23



24 ÷ 31



32 ÷ 39



40 ÷ 47



48 ÷ 55



56 ÷ 63



64 ÷ 71



72 ÷ 79



80 ÷ 87



88 ÷ 95



96 ÷ 103



104 ÷ 111



112 ÷ 119



120 ÷ 127



## Chapter 5

# INSTALLATION NOTES and DIAGRAMS

<b>INSTALLATION NOTES</b>	<b>5.1</b>
<b>Graphic symbols</b>	<b>5.2</b>
<b>Main features</b>	<b>5.3</b>
- Example schematics and calculation of the devices equivalent loads and impedances	5.3
<b>Conductors</b>	<b>5.4</b>
- Tables of conductores	5.4
- Schematic for distance calculation	5.4
<b>Videointercom system connections</b>	<b>5.6</b>
- Internal stations and floor video distributors - Connections and combinations	5.6
- Video signal amplification	5.8
<b>Intercom system connections</b>	<b>5.10</b>
<b>Door station connections</b>	<b>5.11</b>
- Door open warning or other functions	5.13
<b>Internal station connections</b>	<b>5.14</b>
<b>How to increase the number of risers and external door stations</b>	<b>5.15</b>
<b>INSTALLATION DIAGRAMS</b>	<b>5.16</b>
<b>Article list</b>	<b>5.44</b>

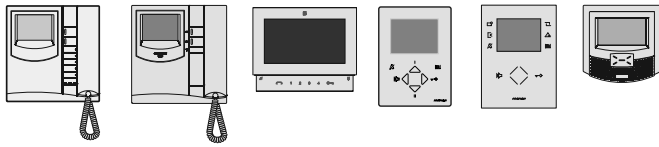
# INSTALLATION NOTES

## Graphic symbols

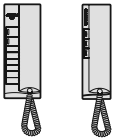
For a better comprehension of the installation diagrams we have made a list of the graphic symbols most often used.

### INTERNAL STATIONS

#### Videointercoms (VC)

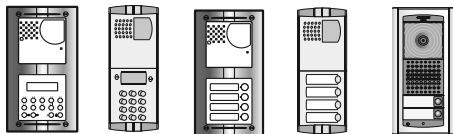


#### Intercoms (CT)

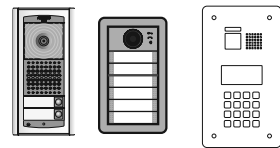


### EXTERNAL DOOR STATIONS (PE)

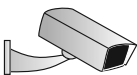
#### Push-button panel with local power



#### Powered from the bus push-button panel



#### Surveillance camera

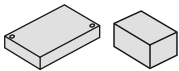


### POWER SUPPLIES AND SERVICE MODULES

#### Power supplies, transformers, amplifier, actuators, buffers and line distributors



#### Floor and risers distributors



#### Doorkeeper exchanger



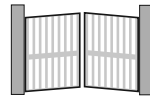
### OTHER SYMBOLS



Push-button



Electric door lock



Automatic gate



**J.. mobile jumpers** to adjust line impedance (available in floor distributors and video amplifiers) and program external door stations, and devices. Their correct position allows for the correct operation of the installation.



**SW.. microswitches** in digital encoders and push-button modules. They must be positioned as indicated in the installation diagrams and installation instructions.



**Twisted cable** for the connection of the DUO digital line



**Optional wire** (normally for connection of floor buttons and door lock button)



**Division lines** (for convenience purposes only the first and last user are illustrated in multi-way installations. Theoretically, all articles that are necessary for the installation are included between the two division lines)



**Sections.** The letters shown in the circle are the reference letters of the distance table on page 5.4.



**Indication extension of installations.** More posts and / or door stations.



**Points of possible connection** of main (P) or secondary (S) PDX2000 doorkeeper exchanger.



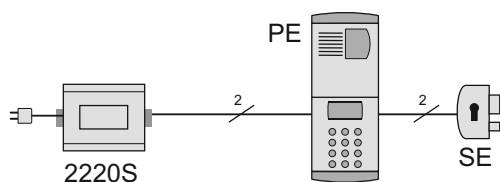
**Switchboard.** We recommend to install all articles in this frame in the same switchboard.

## Main features

- The **cable runs** of intercom and video intercom installations must be kept separate from the mains or any other electrical installation as required by the **International Safety Standards** and the entire installation must be realized in compliance with the safety rules in force in any specific Country.
- The DUO videointercom system needs a correct power supply and audio, video and data impedance over the riser line. It is recommended to comply with the instructions provided in this chapter to get the best audio-video performance possible. The noncompliance with these rules could result in the following drawbacks typical of 2 wire video intercom systems:
  - data transmission errors with possible inability to make calls and service activation;
  - disturbed or poor quality video images;
  - disturbed audio.

## Power supplies

- It is necessary to provide a disconnecting and safety switch before the power supply. Use a single general switch in case of several power supplies (also in multiple entrance).
- Before connecting the power supplies make sure that the rating complies with the electrical mains.
- Except for powered from the bus external stations, the **2220S** power supply provides power to an door station (PE), electric door lock (SE) and name plate lighting. If the system has several external stations, use a power supply for each door station.



- The **2221MQ** (or **2221S**) line power supply provides the power to apparatus connected to the DUO line (intercoms, video intercoms, floor or riser distributors, powered from the bus external door stations, actuators for services, doorkeeper exchanger, etc.). Several power supplies can be used, if connected correctly, in the following cases:
  - excessive load (the sum of the apparatus equivalent loads ( $C_E$ ) connected to the DUO line is greater than available from the power supply;
  - installation on several independent risers (add a power supply for each riser).

## Impedance

When designing a 2-wire DUO digital system, in addition to the absorption of the apparatus, it is also necessary to calculate the impedance of the DUO line determined by the number of devices connected. The equivalent total system impedance is calculated by summing the impedances  $Z_E$  (see table 5.1) of each device.

The presence of the line separators item **2231Q** allows several separate DUO lines. In this case, to calculate the impedance of each line, it is necessary to sum the impedances of the devices on the common part of the line with that on each single riser. On each DUO line the maximum total equivalent impedance allowed is **700  $Z_E$** .

**Table 5.1. Loads and equivalent impedances of devices (\*)**

Rif.	Device	$C_E$	$Z_E$	$Z_E = < 700$
AL	2221MQ	400 **	10	There can be a maximum of 3 DV2420 line distributors on each riser.
	2221S	700 **	10	
AT	2281Q	10 ***	10	
AV	2223Q	15	10	
MO	VM2521	10	10	
DL	DV2420	30	10	
DM	DM2421	10	8	
	DM2444	10	8	
DV	DV2421Q	0	0	
	DV2422A	10	8	
	DV2424Q	0	0	
PDX	PDX2000	30	10	
PE	AD2101AGL	20	15	
	AD2110MAS	-	0	
	AD2120CPL	-	0	
	AD2121CAG/L	-	10	
	CA2124AB	20	10	
	CD213..MAS	-	10	
	CD213..PL	-	10	
	CT2138AB	12	0	
	CV2124AB	20	10	
	TD2000.	80	10	
	TD2000.A	80	10	
	TD2100MAS	-	10	
	TD2100PL	-	10	
	VD2101AGL	20	15	
	VD2120CMAS	-	0	
VD2120CPL	-	0		
VD2121CAG/L	-	10		
SM	2231Q ▲	8	8	
ST	2287	10	10	
CT	EX352	8	10	
	EX362	10	10	
VC	EX3252C	8	10	
	EX3262C	10	10	
	ML2002C	10	10	
	SE4252	10	10	
	ZH1252W	8	10	
	ZH1262	10	10	

(\*) Values for each single unit.

(\*\*) Maximum load supplied by the **2221MQ** or **2221S** power supply.

(\*\*\*) Equivalent load **2281Q** always active = 50.

$C_E$  = Equivalent load related to the current absorption of the device. The total load of the various devices must not exceed the value of the chosen power supply (**2221MQ=400  $C_E$  / 2221S=700  $C_E$** )

$Z_E$  = Equivalent attenuation impedance of the device on the DUO line. The total equivalent impedance of the various devices must not exceed the value of **700  $Z_E$** .

▲ **Attention!** These items divide the system into two separate DUO lines, before proceeding with the calculation, read the section "Impedance".

## Conductors

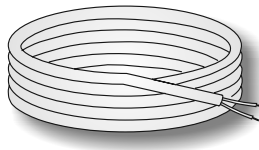
For connection of equipment throughout the Duo digital system a non-polarised two conductor cable is used preferably with twisted wires. The wires must be sized according to the distance to the various apparatus and the number of modules to be applied.

It is also important to comply with the recommended maximum distances between the various apparatus as indicated in the table of wire sizes. The use of inadequate wire sizes and a lack of compliance with the distance between the various apparatus could compromise the performance and affect the proper operation of the system.

**2302.** Twisted pair cable specified for the digital installation with DUO systems.

### Technical characteristics of cable

Number of conductors: 2  
 Colour of conductors: red/black  
 Cross-section: 2x1mm<sup>2</sup>  
 Material: tinned copper  
 Twisting pitch: 40mm  
 Nominal impedance: 100Ω



**2302E.** Cable for outdoor use with the same characteristics as item 2302.

**Table 5.2.**  
**Maximum permitted distances of the intercom systems (measures in meters)**

Section	Type of cable			
	Farfisa art.2302 2x1mm <sup>2</sup>	NOT twisted AWG18 2x0.75mm <sup>2</sup>	Twisted AWG22 2x0.32mm <sup>2</sup>	CAT5 AWG24 2x0.2mm <sup>2</sup>
<b>A</b>	50 m.	50 m.	35 m.	10 m.
<b>C</b>	800 m.	650 m.	250 m.	150 m.

**A** = Distance between power supply 2220S and door station.

**C** = Distance between farthest external door stations and internal stations.

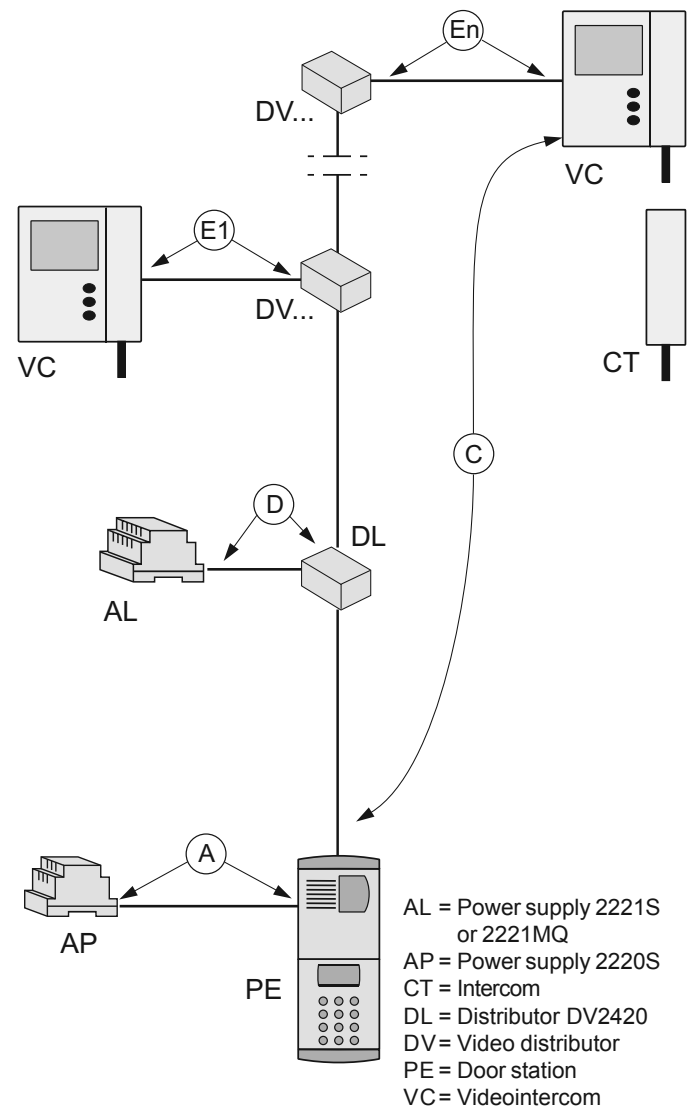
**Table 5.3.**  
**Maximum permitted distances of the videointercom systems (measures in meters)**

Section	Type of cable				Distance between:
	Farfisa art.2302 (2x1mm <sup>2</sup> )	NOT twisted AWG18 (2x0.75mm <sup>2</sup> )	Twisted AWG22 (2x0.32mm <sup>2</sup> )	CAT5 AWG24 (2x0.2mm <sup>2</sup> )	
<b>A</b>	50	35	10	5	art.2220S and external door station
<b>C (*)</b>	200	25	50	40	farthest powered from the bus door s. and internal stations
<b>C (*)</b>	200	30	150	150	farthest traditional door stations and internal stations
<b>D</b>	50	35	5	5	art.2221S-2221MQ and DV2420
<b>E</b>	30	20	20	20	art.DV2421-DV2424 and internal station connected to it
<b>E1+E2+..En</b>	300	200	300	300	adding all the <b>E</b> sections

(\*) These distances can be increased by applying one or more video amplifiers correctly.

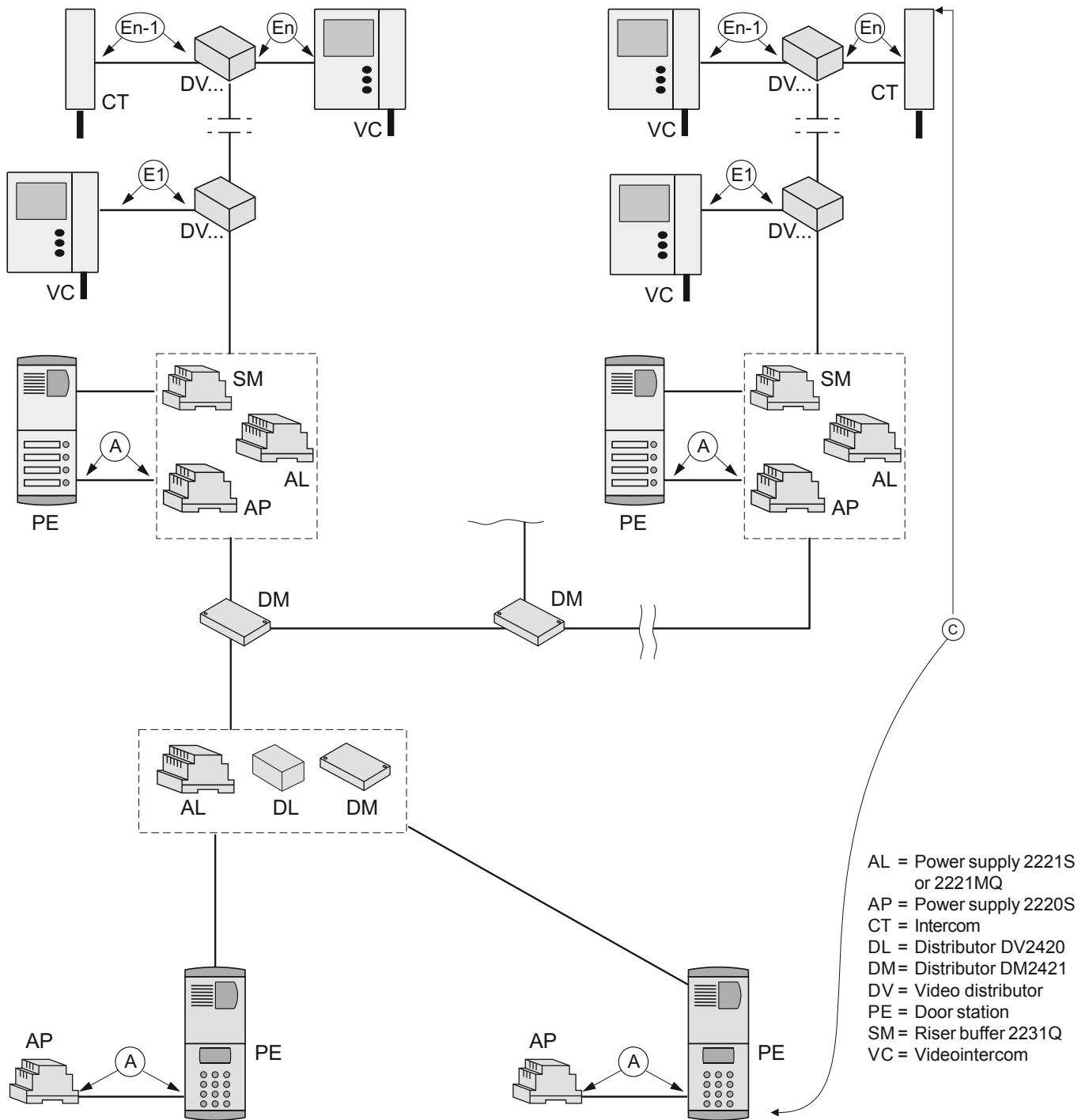
## Schematic for distance calculation

### Video intercom system to 1 external station and 1 riser



# INSTALLATION NOTES

Multi-way installation with 2 main common entrances and 2 risers, each riser with 1 secondary door station



**Notes.**

- The total length of (E1), (E2).. (En) should not exceed 300 meters.
- The section C is the maximum distance of the installation (distance between farthest internal station and external door station).
- For higher distances of section C one or more line amplifiers art. 2223Q must be used.

## Video intercom connections


Each DUO line (main or derived) must have the final section terminated in order to have the correct resistive load. Normally the line terminating equipment is the internal station (video intercoms and/or intercoms) which are therefore provided with jumpers for line matching.

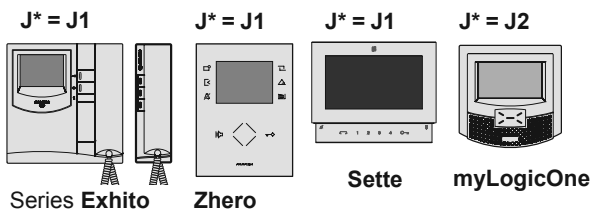
As standard, all internal stations are designed to have a line impedance of 100Ω.

This configuration can be varied only in the following cases:

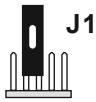
- video signal interference; change impedance to 15Ω;
- internal station is not the last apparatus; move the jumper to the open line (see the "intercom/video intercom serial connection to the distributor output" section).

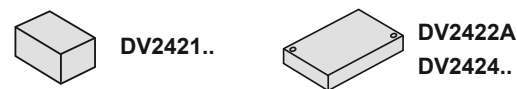
**Table 5.4. Adaptation impedance closing in internal stations of the DUO line (LM terminals)**

Jumpers	Position of the jumpers
 J*	1-2 = termination 100Ω (default)
	2-3 = termination 15Ω
	3-4 = open line



**Table 5.5. Adaptation impedance closing in video distributors of the DUO line (LO terminals)**

Jumpers	Position of the jumpers
 J1	1-2 = termination 47Ω
	2-3 = open line (default)
	3-4 = termination 70Ω
	4-5 = termination 100Ω



## Connection of video intercoms, intercoms and actuators to the riser line

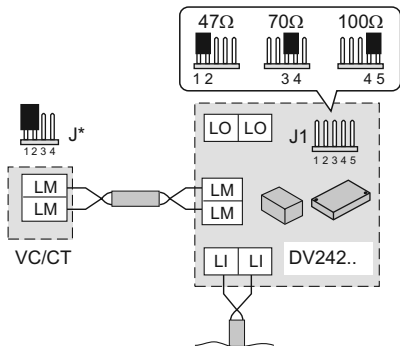
For a correct video signal distribution an active or passive floor distributor must be used. To match the distributor and internal station consult the following table.

**Table 5.6. Choice of distributor depending on the internal station used**

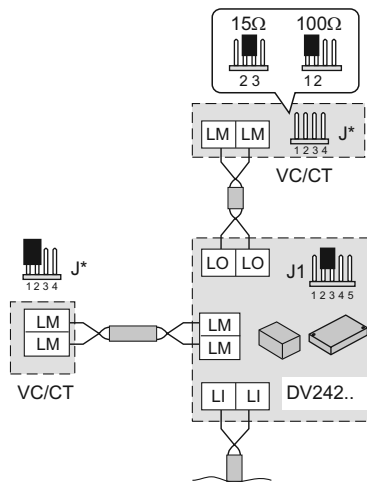
Internal station	Floor distributors and name of derived outputs			
	active			passive
	DV2421Q	DV2424Q	DV2422A	DV2420
	LM	LM	L1 / L2	LM
2281Q	-	-	-	✓
EX3252C	✓	✓	✓	-
EX3262C	✓	✓	✓	-
EX352	✓	✓	✓	-
EX362	✓	✓	✓	-
ML2002C	✓	✓	✓	-
SE4252	✓	✓	✓	-
ZH1252W	✓	✓	✓	-
ZH1262	✓	✓	✓	-

## Ways of terminating the impedance of the DUO line on the last riser video distributor

**a) LO terminals not connected** Terminate the line impedance placing the jumper J1 in one of the three possible positions



**b) LO terminals located at the last riser video intercom/intercom.** The line impedance is terminated placing the jumper J\* (see table 5.4) of the video intercom or the intercom in one of the 2 possible positions. The jumper J1 on the distributor must be left in the open line (2-3) position.



VC/CT = videointercom or intercom

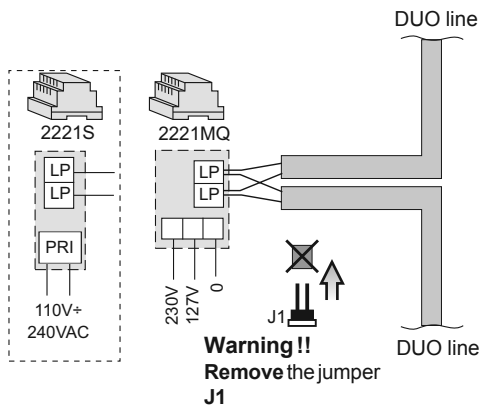
## Connection of art. 2221MQ or 2221S to the DUO line

The power is supplied to the riser by art. 2221S or 2221MQ that must be installed between the first internal station and the external door station (or line buffer, in case of multiple risers). Each riser must have its own line power supply.

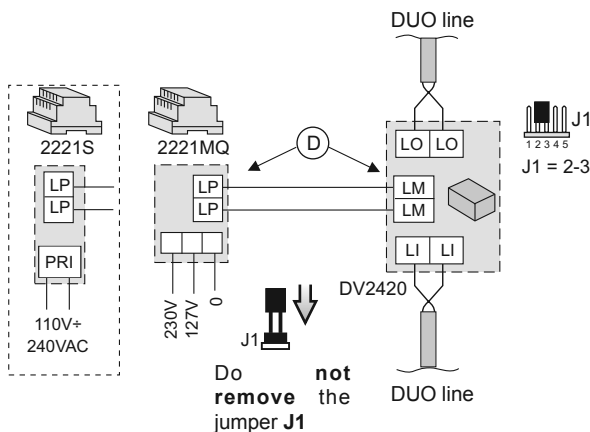
Art. 2221MQ or 2221S can be connected to its line in five different modes:

- directly to the line with connection in -out of the wires;
- through connector box with 1 metre maximum distance;
- through line distributor DV2420;
- through line buffer 2231Q;
- through distributor of riser DM2444.

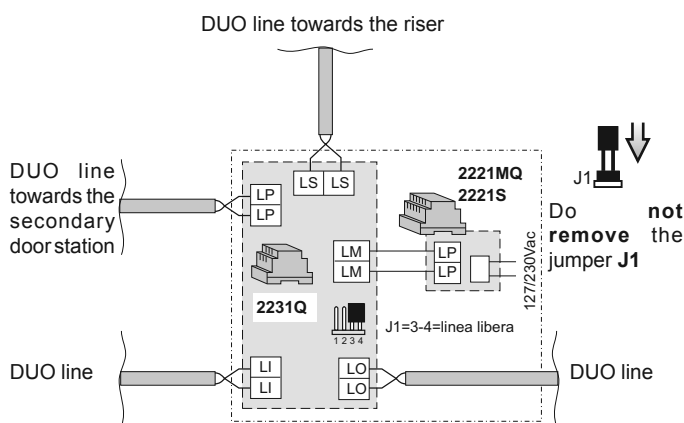
### Connection in-out directly from the line



### Connection with line distributor DV2420



### Connection with buffer of riser 2231Q



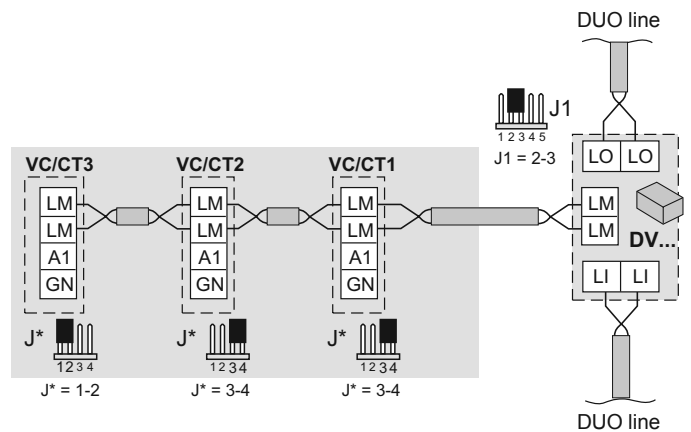
## Connection with floor distributor

The floor distributors must have the jumper J1 in position 2-3 (open line) except the last one which must terminate and match the line impedance. The last video distributor can also be terminated by connecting a video intercom or intercom. Choose between the positions 1-2 (47Ω), 3-4 (70Ω) and 4-5 (100Ω) depending on the video quality obtained. Also all the individual video intercoms (VC) and/or intercoms (CT) connected to the outputs must have the line terminated (to find the position and the name of the jumper, see table 5.4 and the descriptions of each individual item).

### Intercom/video intercom serial connection to the floor distributor output

Each output of the distributors can be connected to up to 3 intercoms/video intercoms connected serially (in-out).

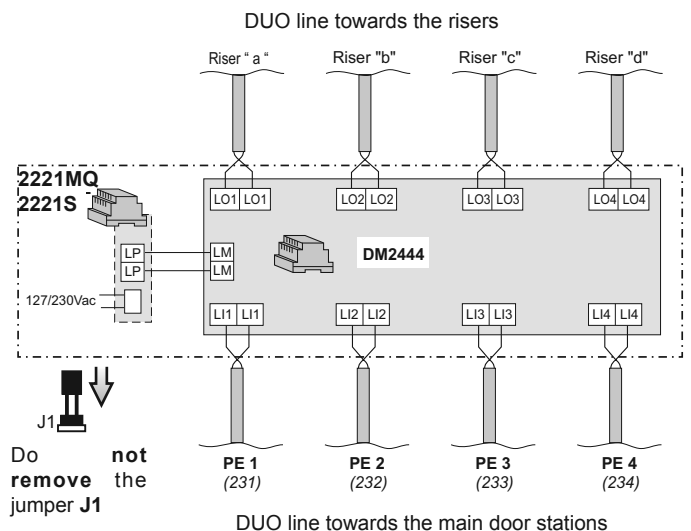
In this case the line impedance must be terminated only on the last internal station (normally jumper J1 or J2 position 1-2 depending on the model) while the other must have the line open (position 3-4).



**Attention!** Place the line termination jumper J.. of the video intercoms or intercoms on the following way:

- VC/CT1 between 3 and 4 (open line)
- VC/CT2 between 3 and 4 (open line)
- VC/CT3 between 1 and 2 (closing on 100Ω) or between 2 and 3 (closing on 15Ω)

### Connection with distributor of risers and entrances DM2444



# INSTALLATION NOTES

## VIDEO SIGNAL AMPLIFICATION

Connecting the art.2223Q video amplifier in the video door entry system DUO you can increase the maximum distance allowed on one single section, but not the maximum number of internal stations.

### Connection of video amplifier to increase the riser length

If the length of section C (distance between external door station and last videointercom) is **higher than 200 meters** (using 2302/2302E), the riser line must be interrupted by adding the necessary devices according to the information contained in the 2 application diagrams below. These diagrams can be inserted in all basic videointercom diagrams.

#### a) - Application diagram of amplifier art. 2223Q directly powered from DUO line

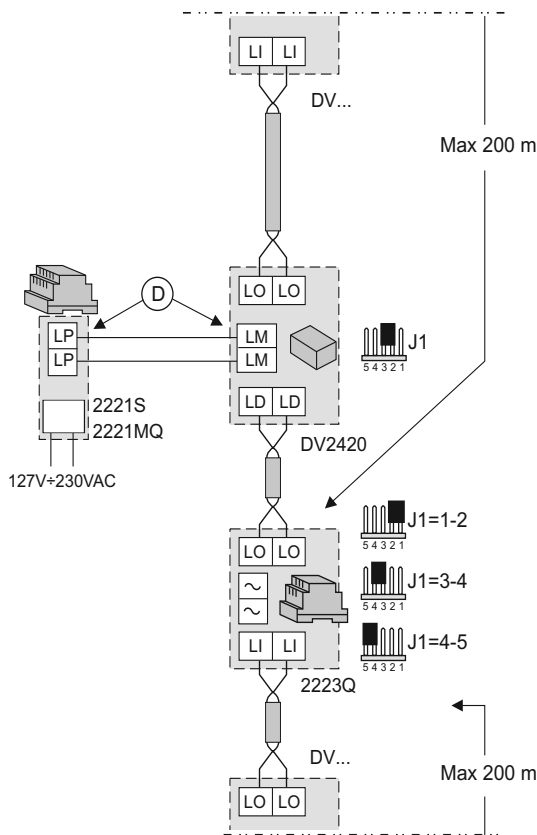
The following articles must be added to the basic diagram as illustrated in the diagram below:

- video amplifier art. **2223Q**

and to restore the line power supply

- line distributor **DV2420**

- line power supply art. **2221S** or art.**2221MQ**



#### b) - Application diagram of amplifier art. 2223Q powered from additional transformer

The following articles must be added to the basic diagram as illustrated in the diagram below:

- video amplifier art. **2223Q**

- transformer **PRS210**

and to restore the line power supply

- line distributor **DV2420**

- line power supply art. **2221S** or art.**2221MQ**

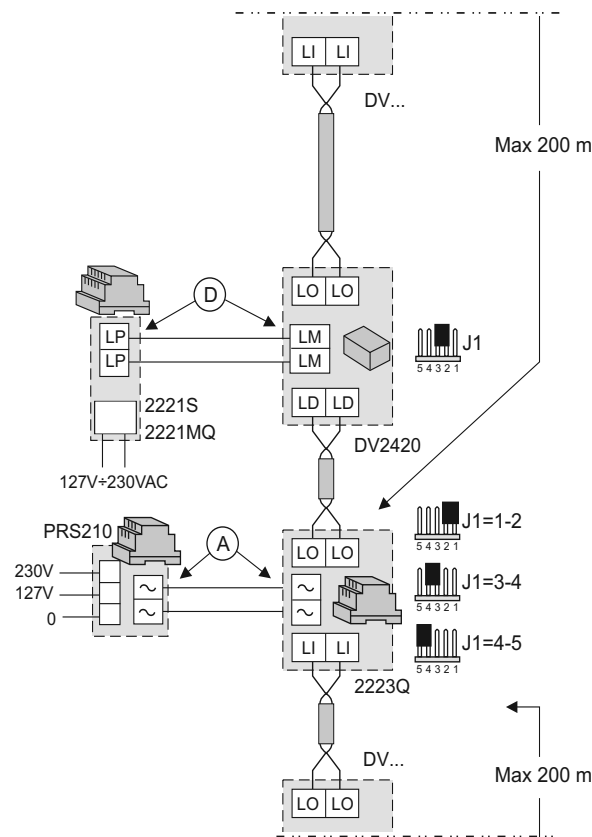


Table 5.7

Position and description of the jumpers of the items			
Articles	Jumpers		Description
DV2420	J1	2-3	open line
2223Q	J1	1-2	termination 47Ω
		3-4	termination 70Ω
		4-5	termination 100Ω



# INSTALLATION NOTES

## Amplifier between external unit and riser power supply

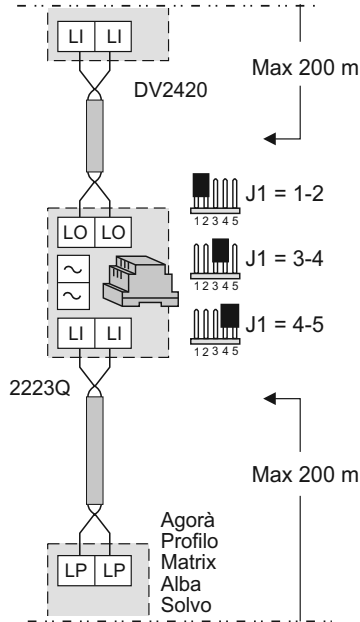
Another possible location of the amplifier is that between the external unit and riser power supply, if distances make it necessary.

**Connection of the video amplifier to increase the distances between riser and external station:**

### a) - Application diagram of amplifier art. 2223Q directly powered from DUO line

The following articles must be added to the basic diagram as illustrated in the diagram below:

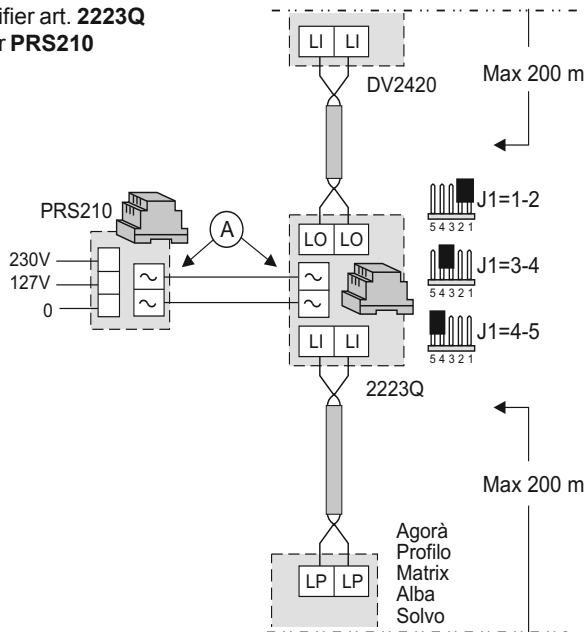
- video amplifier art. **2223Q**



### b) - Application diagram of amplifier art. 2223Q powered from additional transformer

The following articles must be added to the basic diagram as illustrated in the diagram below:

- video amplifier art. **2223Q**  
- transformer **PRS210**

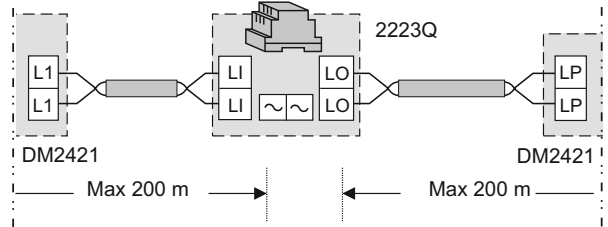
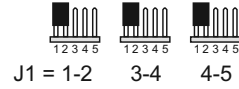


## Amplifier between risers

### a) - Application diagram of amplifier art. 2223Q directly powered from DUO line

Add:

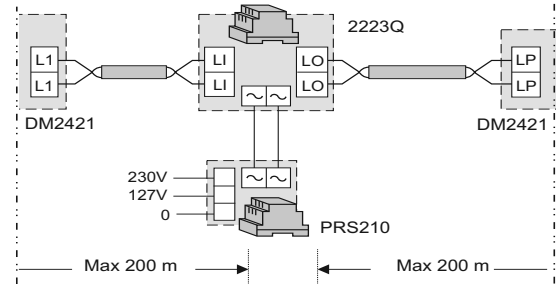
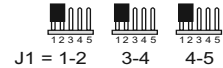
- video amplifier art. **2223Q**



### b) - Application diagram of amplifier art. 2223Q powered from additional transformer

Add:

- video amplifier **2223Q**  
- transformer **PRS210**



5

DUO system

VIDEO INTERCOMS

## Intercom system connections

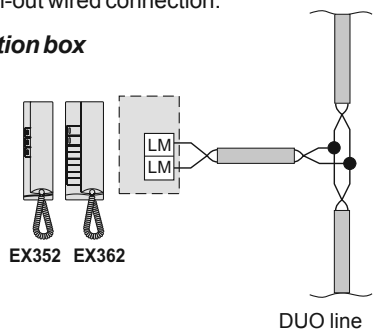
An intercom system is a system composed **exclusively** of intercoms and door stations with **only** audio. For mixed systems (intercoms and video intercoms) or for the use of an external audio-video station, see the chapter "Connections for video intercom systems".

### Connection of intercoms to the riser

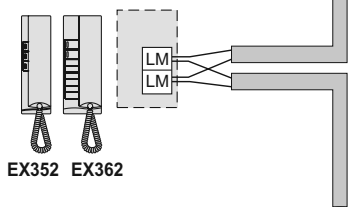
There are substantially 2 ways of connecting an intercom to the DUO line:

- a) through a landing junction box;
- b) directly to the line with an in-out wired connection.

#### a) Through a landing junction box



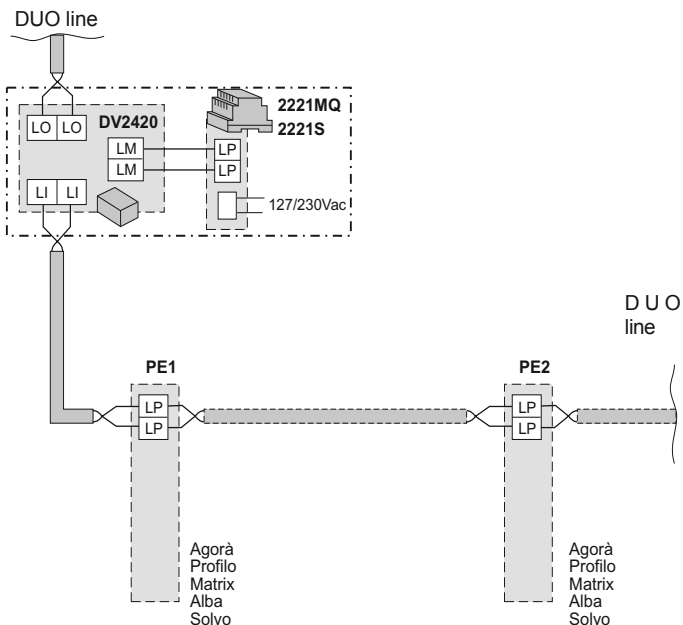
#### b) Connection in-out directly from the line to the intercom



## Connection of the main and secondary door stations

Several main and secondary external stations may be installed in an intercom system, each one powered by its own specific 2220S power supply or powered from the bus. The main external stations can be applied at any point in the DUO line connected to the IN input of the DV2420 distributor or, if not present, to the LP input of the 2221MQ (or 2221S).

### Connection in-out directly from the line

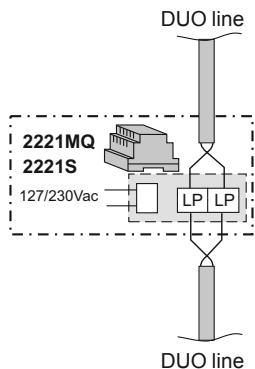


## Connection of the power supply to the riser

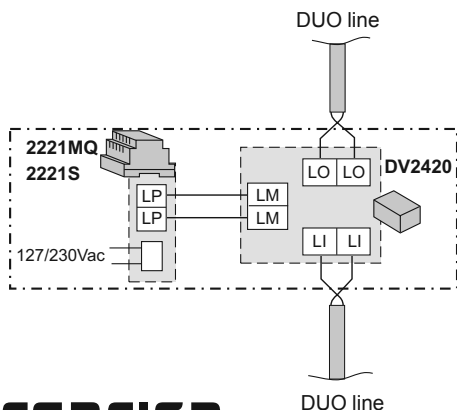
On the DUO 2-wire line, in addition to digital signals for calls, conversations and auxiliary activations, the power is carried to all the connected apparatus. The 2221MQ (or 2221S) power supply can be connected directly to the line or through the DV2420 distributor.

### Connection in-out directly from the line

This type of connection should be used only if there are **more than 5** intercoms installed in the system or if **external door stations** are powered from the bus.



### Connection with line distributor DV2420



# INSTALLATION NOTES

## DOOR STATION CONNECTIONS

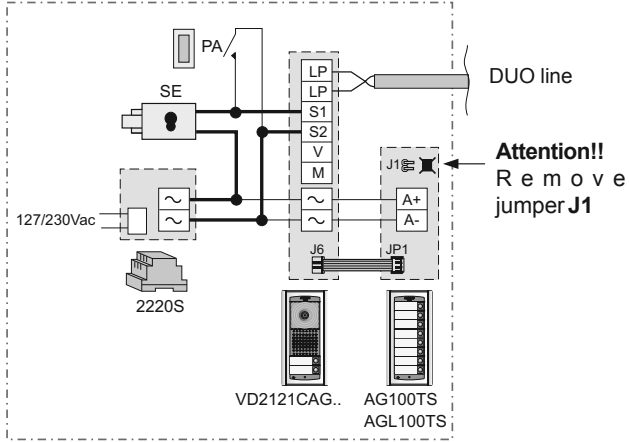
### Door stations with digital encoder CD2131..., CD2132..., CD2134..., CD2138..

In systems with a digital encoder, using the MA24S, PL24S, PL228S, AG100TS and AGL100TS push button modules, it is better to power the illuminated name plates of these modules with an additional 13Vac transformer of sufficient power.

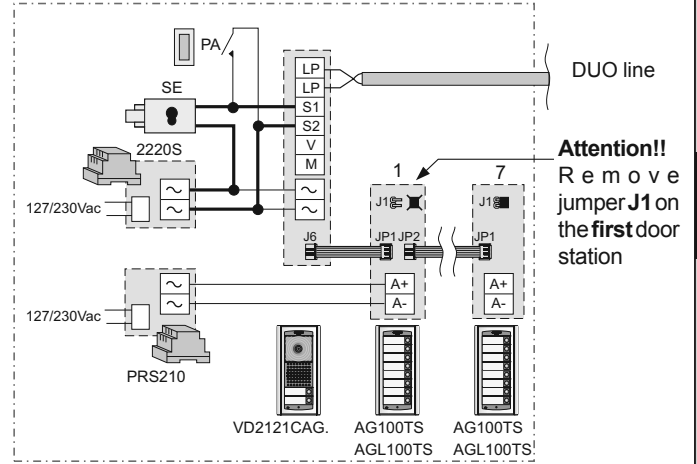
Using the PRS210 transformer you can supply up to a maximum of: 7 AG100TS, AGL100TS external stations; 6 PL24S, PL228S push button modules; 6 MA24S push button modules.

### Agorà series

#### Connecting an external door station with up to 10 buttons

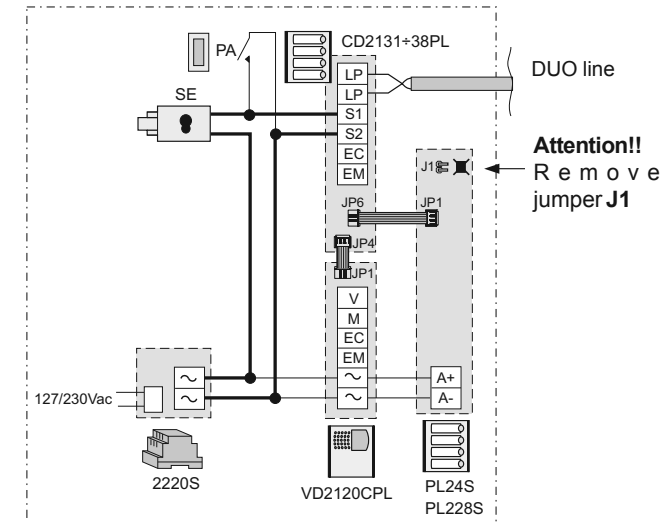


#### Connecting an external door station with up to 122 buttons

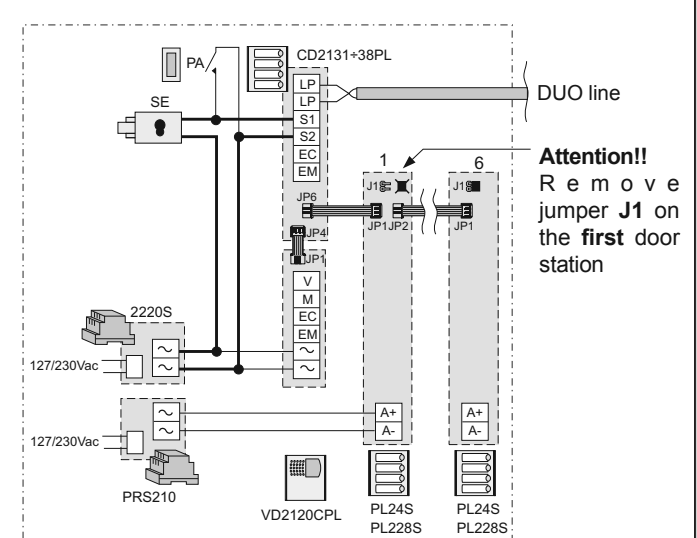


### Profilo series

#### Connecting an external door station with up to 8 buttons (or 16 if double row)

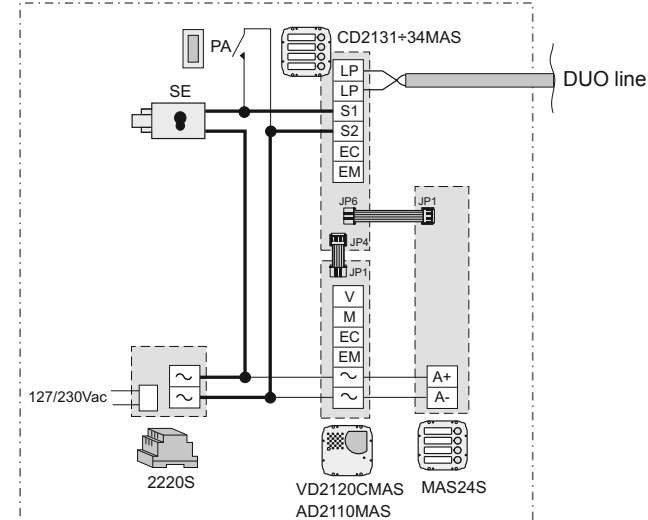


#### Connecting an external door station with up to 128 buttons

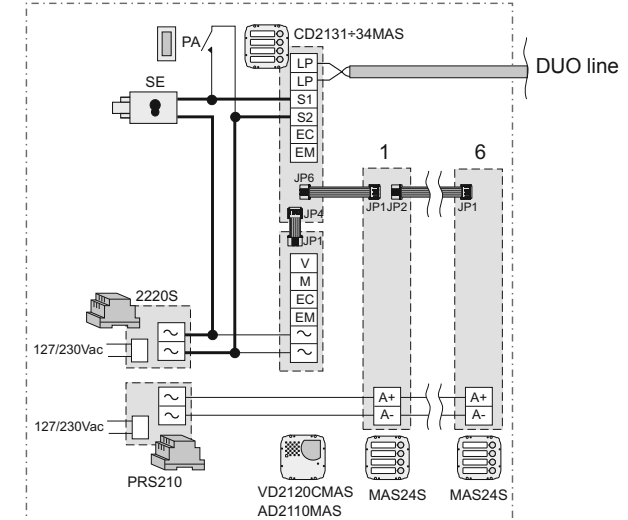


### Matrix series

#### Connecting an external door station with up to 8 buttons



#### Connecting an external door station with up to 128 buttons



# INSTALLATION NOTES

## Door stations with digital keyboard TD2100PL or TD2100MAS

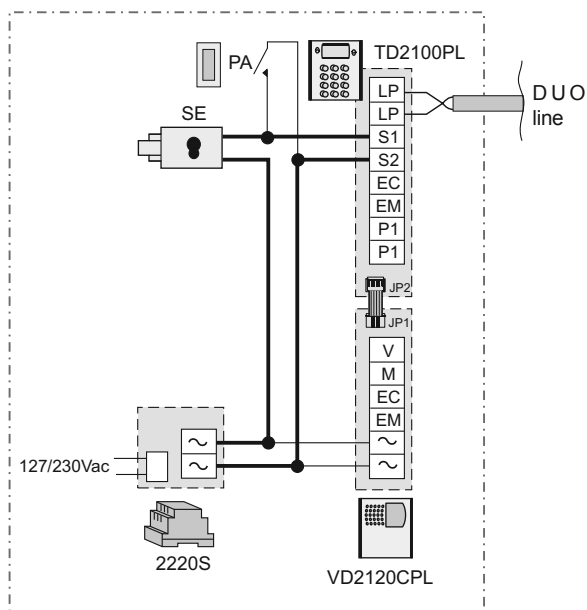
Using the **TD2100PL** (or **TD2100MAS**) digital keyboard in place of the push button modules allows a reduction of the external station dimensions and a greater number of users can be activated. Furthermore it is possible to operate the electric lock directly from the keyboard by composing one of the **sixteen** personal codes that can be activated. Use the programming code **00** to insert lock activation codes. It is also recommended that you program **bit 2** of the system programming (code **03**) to shorten the activation procedure.

### Direct call to an internal with additional button

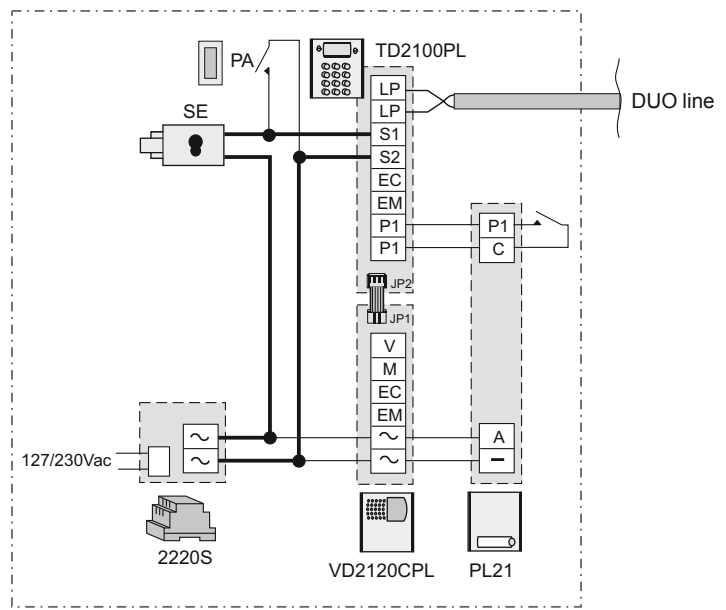
It is possible to connect an external button to the **TD2100..** digital keyboard to allow a direct call to an internal (e.g. call the doorkeeper, an office, etc). For this service, it is required to:

- add the **PL21** (Profilo series) 1 push button module or the **MAS22** (Matrix series) 2 push button module;
- connect the **P1** and **C** terminals of the push button module to the **P1** terminals of the keyboard. For the name plate illumination connect the **A** and  $\sim$  terminals;
- program the digital keyboard to insert the user address to call with the additional button (programming code **11** for TD2100PL; **00** for TD2100MAS).

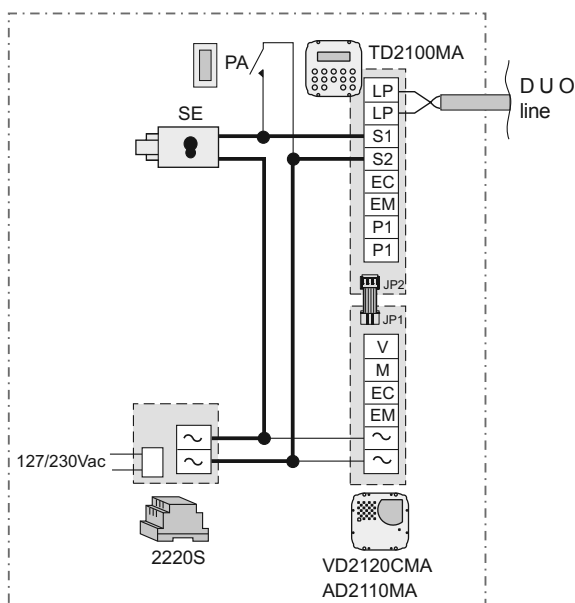
### Profilo series



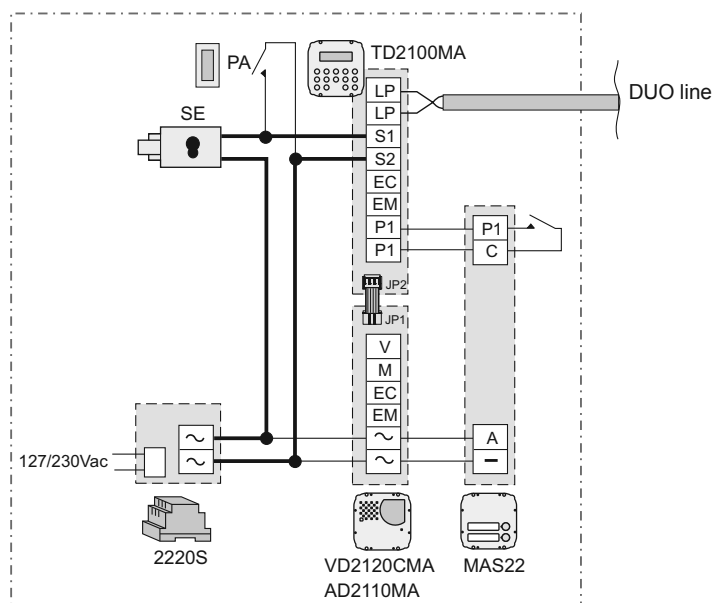
### Connecting a button for direct call to an user



### Matrix series



### Connecting a button for direct call to an user



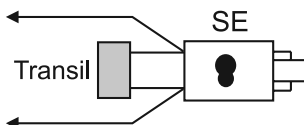
## Electric door lock

As shown in the installation diagrams the electric lock can be operated using the same power supply which powers the door station (in case of locally powered door station)) or directly by the door station itself (in case of power from the bus door station), but for a correct operation the electric lock must be a 12VAC/1A max type. To operate a powerful electric lock it would be advisable to use an extra power supply and an extra relay.

### Very important

To comply with the European Standards on Electromagnetic Compatibility and to increase the reliability of the product, it is necessary to connect a suppression device when switching inductive loads i.e. electric releases and electric locks.

The enclosed suppression devices (transil) must be connected as close as possible to the loads (ideally across the terminals. See figure).



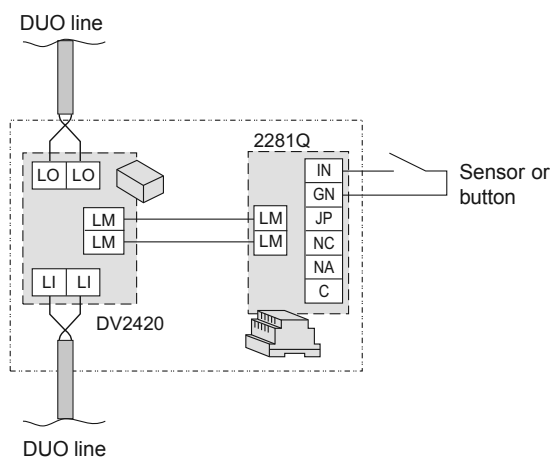
## Door open warning or other functions

To have a door open warning or other similar functions connect a **2281Q** actuator module to the DUO line.

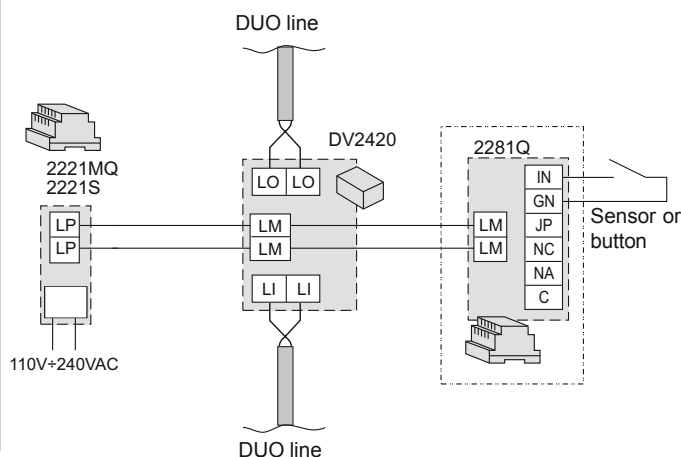
When the contact is closed and the actuator has been correctly programmed:

- on **EX3262C** video intercoms and **EX362** intercoms the yellow led lights;
- on **Sette/Zhero S** video intercoms the related icon led lights;
- on **Zhero** video intercoms the led on the key programmed to operate the actuator lights;
- on **myLogic** video intercoms it is signalled with the screen on in videointercom mode.

### Connecting item 2281Q at any point of the DUO line adding a DV2420 distributor



### Connecting item 2281Q to the DV2420 present on the DUO line



## Programming

### Actuator art.2281Q

- Insert the address that is to be assigned to the relay and then that to assign to the **IN port** (different addresses in the interval **211** to **220** for relay and **221** to **230** for the input port).
- Insert the value to be assigned to the relay mode of operation and then for the command transmitted by the device assign the value **0** to activate the **IN/GN** contacts for signaling door open

### Videointercoms series Zhero

Programming path:

#### Maintenance - Settings - Actuators:

- Enter the same address set for the **IN port** of art.**2281Q**.
- Enter the name of the function (e.g. *door open*).

Key programming path:

#### Maintenance - Settings - Favourite keys:

- Press the key to which the lighting of the relative led is to be associated.
- Choose "actuation" and on the next screen, for example, "*open door*".

### Videointercoms series myLogicOne

Enter the same address set for the **IN port** of art.**2281Q** and the name of the function (e.g. *open door*) in the address book (**contacts**). The activation of the function will be indicated by an exclamation mark at the top left of the

screen **video intercom mode** (auto-ON or call from the external door station).

### Videointercoms series Zhero S ZH1252W and Sette

The activation of the function will be indicated by the related icon led lighting.

### Videointercom EX3262C and intercom EX362

Enter **system programming** and enable operation mode **7**. The activation of the function will be indicated by the yellow led lighting.

## INTERNAL STATION CONNECTIONS

The following schemes can be used in all the systems and allow the simplified connection of up to 3 internal stations (intercoms or video intercoms) in each apartment.

**Attention!** For each diagram there is a total number of internal stations. Enter also the additional ones in this count.

If the intercom service is required, it is sufficient to program the internal stations correctly (see the "Internal address" and "Code to assign to the buttons" programming found in the internal stations description in chapter 2.)

Intercom calls within the same apartment can be either **individual** (each internal apparatus is called by a dedicated button) or **general** (one button calls all internals simultaneously). Read the chapter related to the internal stations described in chapter 2 for the operation.

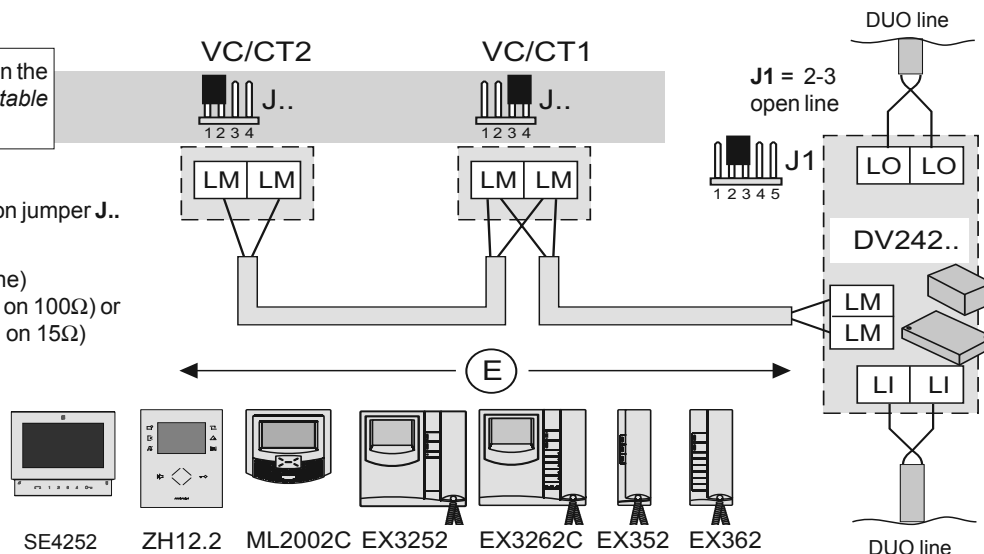
### 2 INTERNAL STATIONS IN PARALLEL WITH OR WITHOUT INTERCOMMUNICATING SERVICE

J... The jumper number depends on the internal station model used. See table 5.4.

**Attention!** Place the line termination jumper J.. on the following way:

**VC/CT1** between 3 and 4 (open line)

**VC/CT2** between 1 and 2 (closing on 100Ω) or between 2 and 3 (closing on 15Ω)



### 3 INTERNAL STATIONS IN PARALLEL WITH OR WITHOUT INTERCOMMUNICATING SERVICE

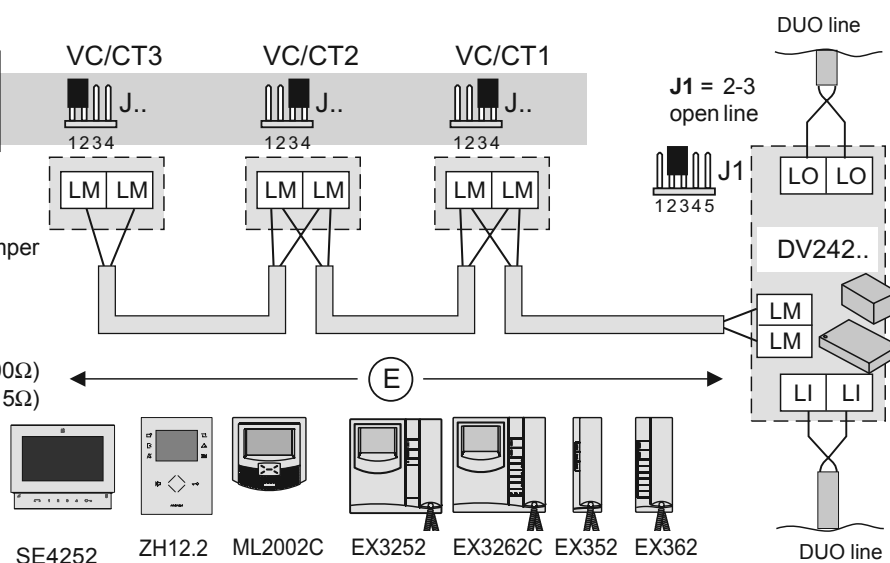
J... The jumper number depends on the internal station model used. See table 5.4.

**Attention!** Place the line termination jumper J.. on the following way:

**VC/CT1** between 3 and 4 (open line)

**VC/CT2** between 3 and 4 (open line)

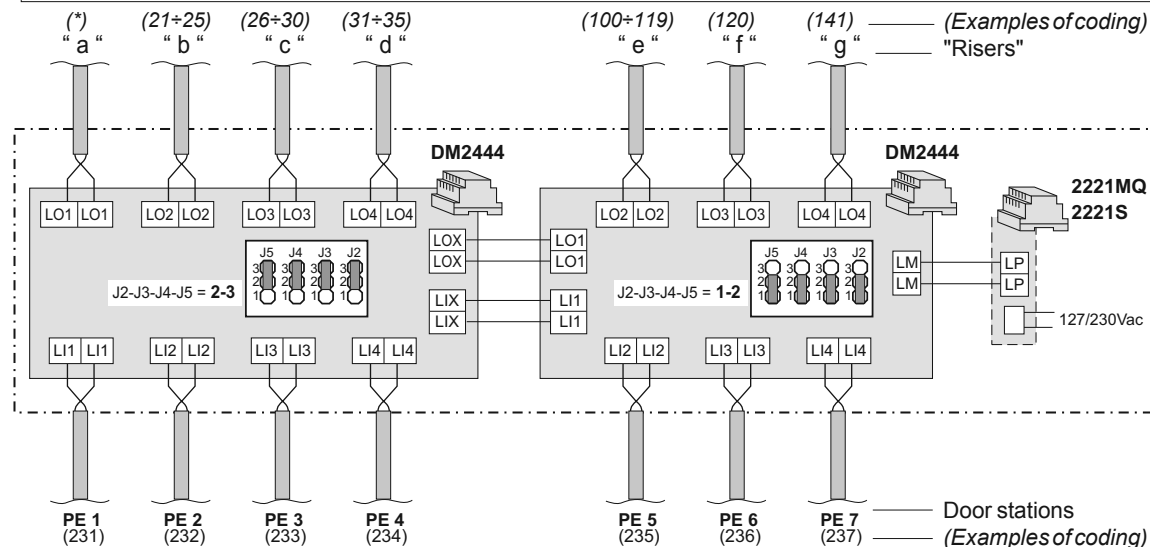
**VC/CT3** between 1 and 2 (closing on 100Ω) or between 2 and 3 (closing on 15Ω)



HOW TO INCREASE THE NUMBER OF RISERS AND EXTERNAL DOOR STATIONS

Connection of 2 distributors to have max 7 external video door stations and 7 risers (or 6 risers and 1 doorkeeper exchanger PDX2000)

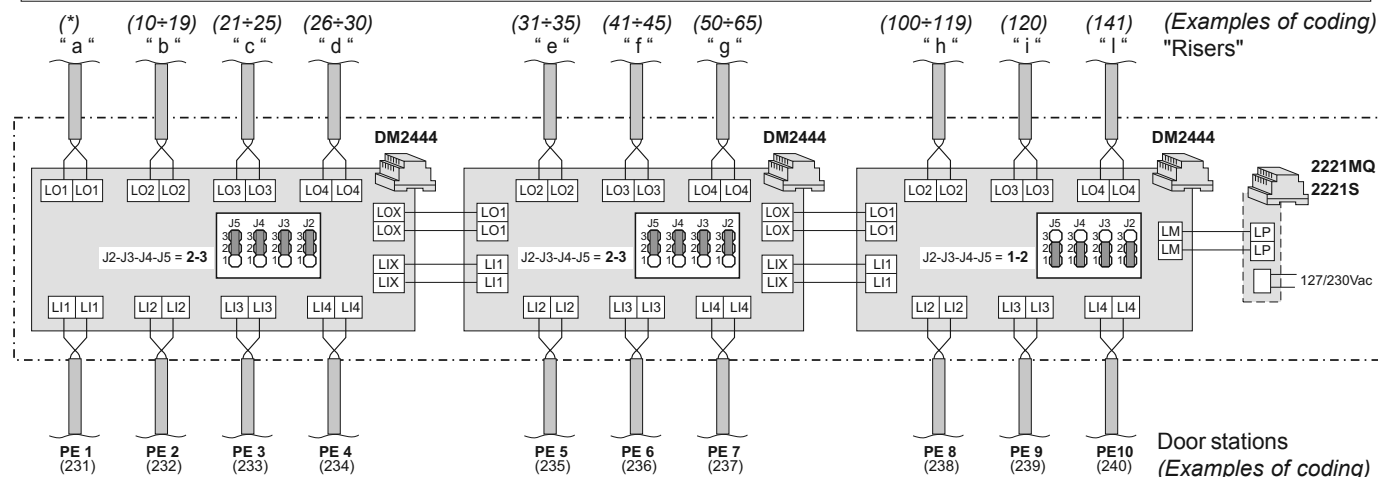
**Videointercom risers ("a" ÷ "g").** The addresses of the internal stations belonging to a riser must be programmed in the output lines of the line distributor (except LO1 \* which allows the transit of all addresses except those programmed in other intervals).



**Video door stations (PE).** The address reported close to each input line must be programmed either on each input line of the line distributor or on each door station (except LI1 which allows the transit of all addresses except those programmed in the other input lines).

Connection of 3 distributors to have max 10 external video door stations and 10 risers (or 9 risers and 1 doorkeeper exchanger PDX2000)

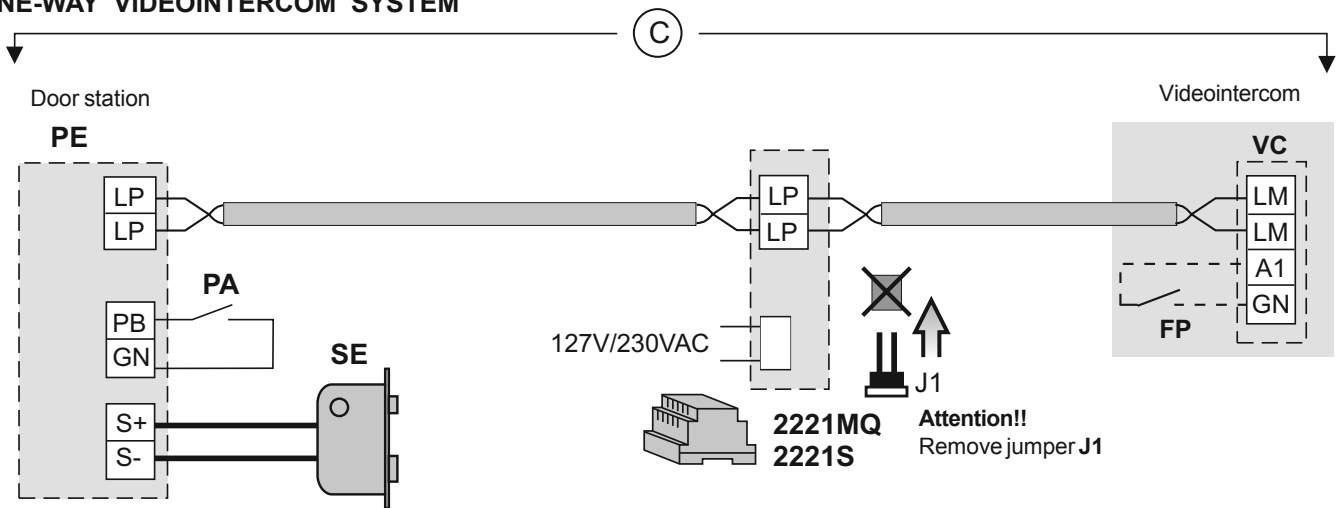
**Videointercom risers ("a" ÷ "l").** The addresses of the internal stations belonging to a riser must be programmed in the output lines of the line distributor (except LO1 \* which allows the transit of all addresses except those programmed in other intervals).



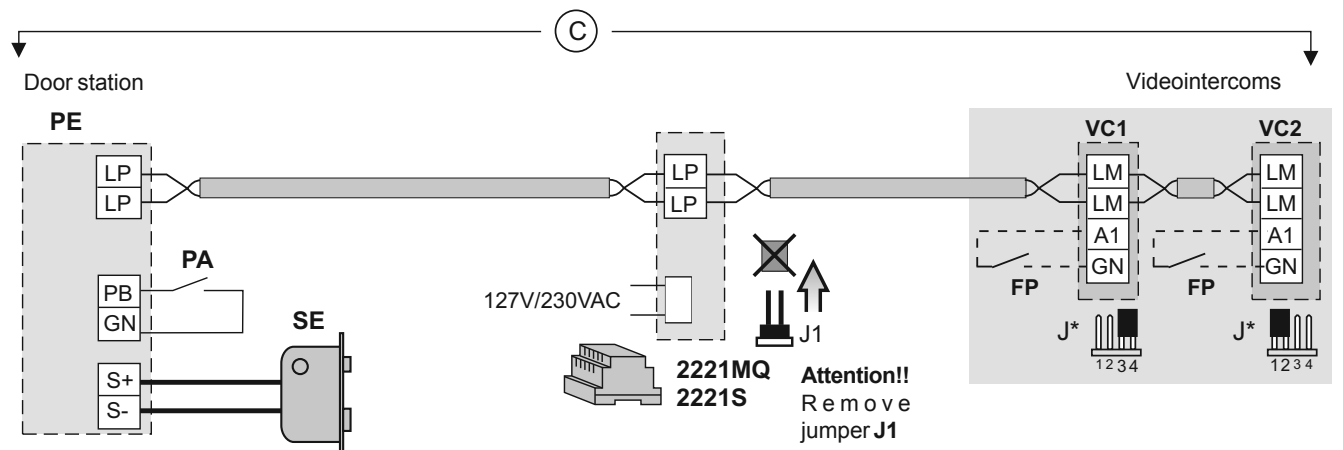
**Video door stations (PE).** The address reported close to each input line must be programmed either on each input line of the line distributor or on each door station (except LI1 which allows the transit of all addresses except those programmed in the other input lines).



ONE-WAY VIDEOINTERCOM SYSTEM



ONE/TWO-WAY VIDEOINTERCOM SYSTEM WITH 2 PARALLEL VIDEOINTERCOMS



Q.ty	Article	Description
1-2	ZH12.2	Zhero videointercom
	ML2002C+ML2083	myLogicOne videointercom + back box
	EX3252C+WB3252	Exhito videointercom + wall bracket
	EX3262C+WB3262	Exhito videointercom + wall bracket
	SE4252	Sette videointercom
1	2221S-2221MQ	Line power supply
1	FP **	Floor push-button (optional)
1	PA **	Door release button (optional)
1	SE **	Electric door lock (12Vac-1A)
● AGORA' series door station		
1	VD2101AGL	Videointercom door station
1	AGL21	Additional button for two-way system
● ALBA series door station		
1	AB71	Module frame
1	AB61	Front frame
1	SC1	Back box
1	AB91 *	Rain shelter
1	CV2124AB	Audio/video module
1-0	AB20	Cover
1-2	AB21	Button module

\* Rain shelters are used in replacement of back boxes.  
 \*\* Articles not supplied by ACI Farfisa.

○ See table 5.3 of the distance.

**Attention!**

- Place the VC1 video intercom line termination jumper J\* between 3 and 4 (open line). Leave VC2 J\* between 1 and 2 (closed with 100Ω).
- In both diagrams, remove jumper J1 from the line powersupply.

J... The jumper number depends on the internal station model used. See table 5.4.

**Programming to be performed (one-way system)**

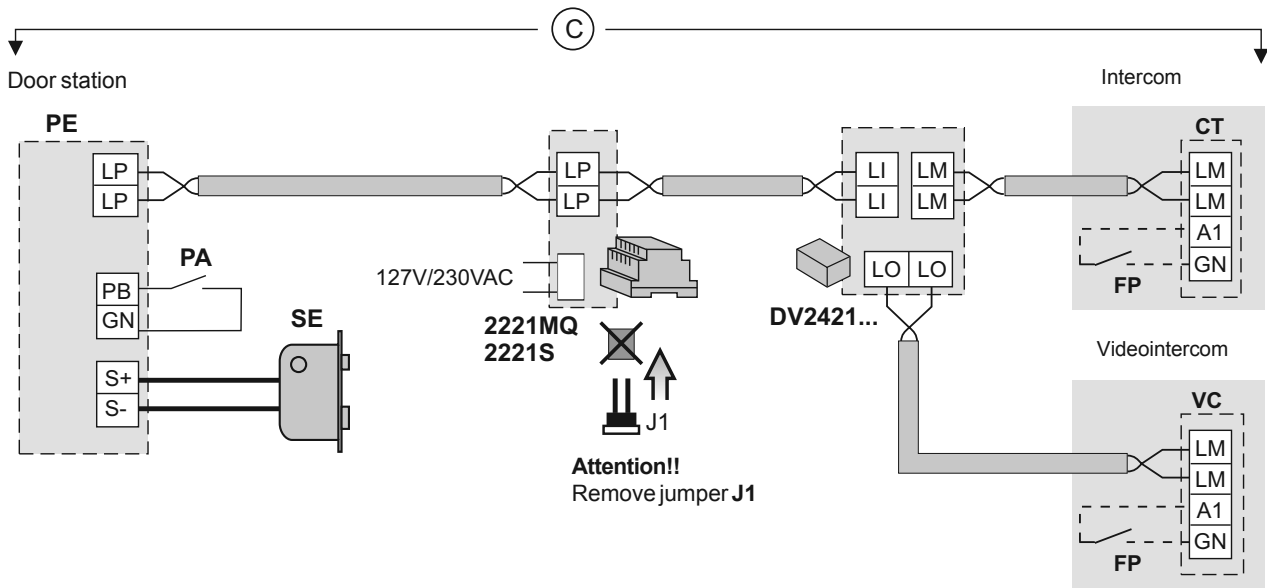
- VC1 - sending floor call to videointercom VC2
- VC2 - to change internal address from 000 to 001

**Attention!**

Floor call button (FP) is connected between terminals A1/A1 for ZH1252W and SE4252.



ONE/TWO-WAY VIDEOINTERCOM/INTERCOM SYSTEM



**Attention!**  
Floor call button (FP) is connected between terminals A1/A1 for ZH1252W and SE4252.

Q.ty	Article	Description
1	ZH12.2	Zhero videointercom
	ML2002C+ML2083	myLogicOne videointercom + back box
	EX3252C+WB3252	Exhito videointercom + wall bracket
	EX3262C+WB3262	Exhito videointercom + wall bracket
	SE4252	Sette videointercom
1	EX352	Exhito intercom
	EX362	Exhito intercom
1	DV2421Q	Video distributor
1	2221S-2221MQ	Line power supply
1	FP **	Floor push-button (optional)
1	PA **	Door release button (optional)
1	SE **	Electric door lock (12Vac-1A)
<b>● AGORA' series door station</b>		
1	VD2101AGL	Videointercom door station
1	AGL21	Additional button for two-way system
<b>● ALBA series door station</b>		
1	AB71	Module frame
1	AB61	Front frame
1	SC1	Back box
1	AB91 *	Rain shelter
1	CV2124AB	Audio/video module
1-0	AB20	Cover
1-2	AB21	Button module
* Rain shelters are used in replacement of back boxes.		
** Articles not supplied by ACI Farfisa.		

○ See table 5.3 of the distance.

**Attention!**  
- In both diagrams, **remove jumper J1** from the line power supply.

**Programming to be performed (one-way system)**

VC - sending floor call to intercom CT  
CT - to change internal address from 000 to 001

## MULTI-WAY SYSTEM CONNECTED TO 1 AUDIO-VIDEO DOOR STATION

## ● Internal Stations: VIDEOINTERCOMS (VC)

series ZHERO	myLogicOne	SETTE	EXHITO	EXHITO	EXHITO
... ZH1262B <sup>(1)</sup>	... ML2002C <sup>(1)</sup>	... SE4252 <sup>(1)</sup>	... EX3262C <sup>(1)</sup>	... EX3252C <sup>(1)</sup>	... EX352 <sup>(1)</sup>
... ZH1262W <sup>(1)</sup>	... ML2083		... WB3262	... WB3252 <sup>(1)</sup>	... EX362 <sup>(1)</sup>
... ZH1252W <sup>(1)</sup>	... WA2160W		... TA3160	... TA3160	... TA320
... TA1260	... TA2160				

## ● INTERCOMS (CT)

## ● External Stations POWERED FROM THE BUS with Digital Encoder (PE)

series AGORA'	series ALBA
... VD2101AGL-AD2101AGL <sup>(1)</sup>	... CV2124AB-CA2124AB <sup>(1)</sup>
... AGL21	... CT2138AB
... AGL20	... AB21
	... AB20
	... AB00-AB50
	... SC1÷SC3
	... AB91÷AB96 <sup>(2)</sup>
	... AB61-AB63
	... AB71-AB73
	... EC733

## ● External Stations POWERED FROM THE BUS with Digital Keyboard (PE)

## series SOLVO

... TD2000-TD2000R-TD2000A-TD2000RA <sup>(1)</sup>
... FP2000
... 290S/0 <sup>(2)</sup>

## ● External Stations TRADITIONAL with Digital Encoder (PE)

series AGORA'	series PROFILO	series MATRIX
... VD2121CAG(L)-AD2121CAG(L) <sup>(1)</sup>	... VD2120CPL-AD2120CPL	... VD2120CMAS-AD2110MAS
... AG100TS-AGL100TS <sup>(1)</sup>	... CD2131PL÷CD2138PL <sup>(1)</sup>	... CD2131MAS÷CD2134MAS <sup>(1)</sup>
... AG21-AGL21	... PL24S-PL228S <sup>(1)</sup>	... MAS24S <sup>(1)</sup>
... AG20-AGL20	... PL20-PL50	... MAS20
... 2220S	... PL72-PL73	... MA72-MA73
... PRS210	... PL82÷PL89	... MAS62-MAS63
	... PL92÷PL99 <sup>(2)</sup>	... MA92-MA93 <sup>(2)</sup>
	... 2220S	... 2220S
	... PRS210	... PRS210

## ● External Stations TRADITIONAL with Digital Keyboard (PE)

series PROFILO	series MATRIX
... VD2120CPL-AD2120CPL	... VD2120CMAS-AD2110MAS
... TD2100PL <sup>(1)</sup>	... TD2100MAS <sup>(1)</sup>
... PL72	... MA72
... PL82	... MAS62
... PL92 <sup>(2)</sup>	... MA92 <sup>(2)</sup>
... 2220S	... 2220S

## ● Other Articles

... DV2421Q	Video distributor with 1 output
... DV2424Q	Video distributor with 4 outputs
... DV2422A <sup>(1)</sup>	Active video distributor with 2 outputs
... 2221MQ - 2221S	Line power supply
... DV2420	Line distributor
... FP <sup>(3)</sup>	Floor push button (optional)
... PA <sup>(3)</sup>	Door release button (optional)
... SE <sup>(3)</sup>	Electrical door lock(12Vac-1A)

... According to the number of users and external stations

<sup>(1)</sup> Articles to be programmed

<sup>(2)</sup> Rain shelters are used in replacement of back boxes.

<sup>(3)</sup> Articles not supplied by ACI Farfisa.

## Installation notes.

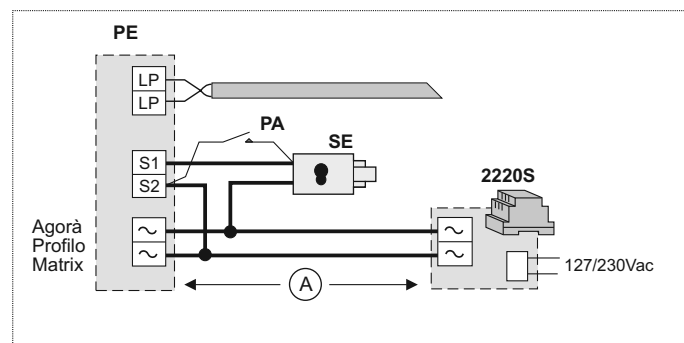
- For maximum users number see table 5.1.

- For the choos and cross section and installation of the wires see table 5.3.

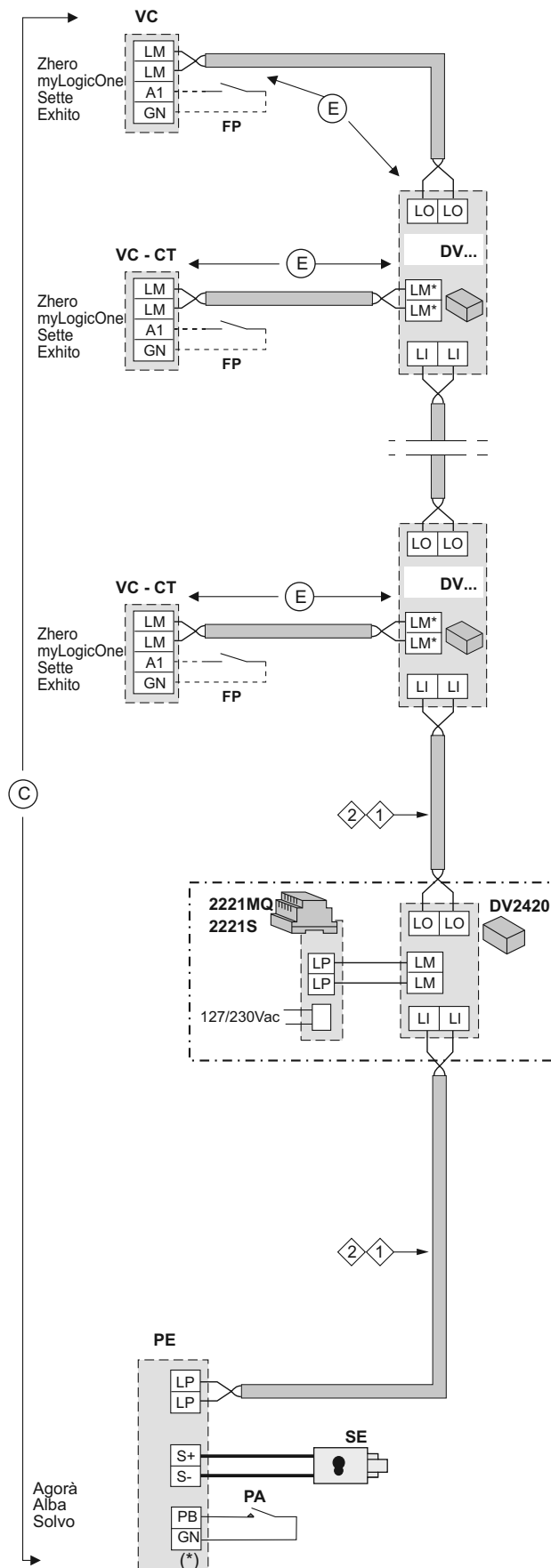
- For the correct operation of the system, jumper **J1** of all the video distributors must be left in position **2-3** (open line). The line impedance is determined by the video intercom connected to the **LO** output of the last video distributor; if this output is not connected close it by positioning jumper **J1** appropriately. The line must not remain open.

- We recommend to install all articles framed with a broken line in the same switchboard.

- Using TRADITIONAL external stations (with 2220S), apply the diagram below:



MULTI-WAY SYSTEM CONNECTED TO 1 AUDIO-VIDEO DOOR STATION



**Attention!**  
Floor call button (FP) is connected between terminals A1/A1 for ZH1252W and SE4252.

**Attention!**  
DV.... To choose the video distributor to match to the video intercom and for the terminal name of the derived outputs (LM\*) see table 5.6.

○ See distance table 5.3

2 1 A doorkeeper exchanger can be applied here if required. For how to connect it see Chapter 4.

(\*) PB/PB in TD2000..

## MULTI-WAY SYSTEM CONNECTED TO 1 AUDIO-VIDEO DOOR STATION AND DIVISION IN 2 RISERS

## ● Internal Stations: VIDEOINTERCOMS (VC)

series ZHERO	myLogicOne	SETTE	EXHITO	EXHITO	EXHITO
... ZH1262B <sup>(1)</sup>	... ML2002C <sup>(1)</sup>	... SE4252 <sup>(1)</sup>	... EX3262C <sup>(1)</sup>	... EX3252C <sup>(1)</sup>	... EX352 <sup>(1)</sup>
... ZH1262W <sup>(1)</sup>	... ML2083		... WB3262	... WB3252 <sup>(1)</sup>	... EX362 <sup>(1)</sup>
... ZH1252W <sup>(1)</sup>	... WA2160W		... TA3160	... TA3160	... TA320
... TA1260	... TA2160				

## ● INTERCOMS (CT)

## ● External Stations POWERED FROM THE BUS with Digital Encoder (PE)

series AGORA'	series ALBA
... VD2101AGL-AD2101AGL <sup>(1)</sup>	... CV2124AB-CA2124AB <sup>(1)</sup>
... AGL21	... CT2138AB
... AGL20	... AB21
	... AB20
	... AB00-AB50
	... SC1÷SC3
	... AB91÷AB96 <sup>(2)</sup>
	... AB61-AB63
	... AB71-AB73
	... EC733

## ● External Stations POWERED FROM THE BUS with Digital Keyboard (PE)

## series SOLVO

... TD2000-TD2000R-TD2000A-TD2000RA <sup>(1)</sup>
... FP2000
... 290S/0 <sup>(2)</sup>

## ● External Stations TRADITIONAL with Digital Encoder (PE)

series AGORA'	series PROFILO	series MATRIX
... VD2121CAG(L)-AD2121CAG(L) <sup>(1)</sup>	... VD2120CPL-AD2120CPL	... VD2120CMAS-AD2110MAS
... AG100TS-AGL100TS <sup>(1)</sup>	... CD2131PL÷CD2138PL <sup>(1)</sup>	... CD2131MAS÷CD2134MAS <sup>(1)</sup>
... AG21-AGL21	... PL24S-PL228S <sup>(1)</sup>	... MAS24S <sup>(1)</sup>
... AG20-AGL20	... PL20-PL50	... MAS20
... 2220S	... PL72-PL73	... MA72-MA73
... PRS210	... PL82÷PL89	... MAS62-MAS63
	... PL92÷PL99 <sup>(2)</sup>	... MA92-MA93 <sup>(2)</sup>
	... 2220S	... 2220S
	... PRS210	... PRS210

## ● External Stations TRADITIONAL with Digital Keyboard (PE)

series PROFILO	series MATRIX
... VD2120CPL-AD2120CPL	... VD2120CMAS-AD2110MAS
... TD2100PL <sup>(1)</sup>	... TD2100MAS <sup>(1)</sup>
... PL72	... MA72
... PL82	... MAS62
... PL92 <sup>(2)</sup>	... MA92 <sup>(2)</sup>
... 2220S	... 2220S

## ● Other Articles

... DV2421Q	Video distributor with 1 output
... DV2424Q	Video distributor with 4 outputs
... DV2422A <sup>(1)</sup>	Active video distributor with 2 outputs
... DM2421 <sup>(1)</sup>	Line distributor
... 2221MQ - 2221S	Line power supply
... DV2420	Line distributor
... FP <sup>(3)</sup>	Floor push button (optional)
... PA <sup>(3)</sup>	Door release button (optional)
... SE <sup>(3)</sup>	Electrical door lock(12Vac-1A)

... According to the number of users and external stations

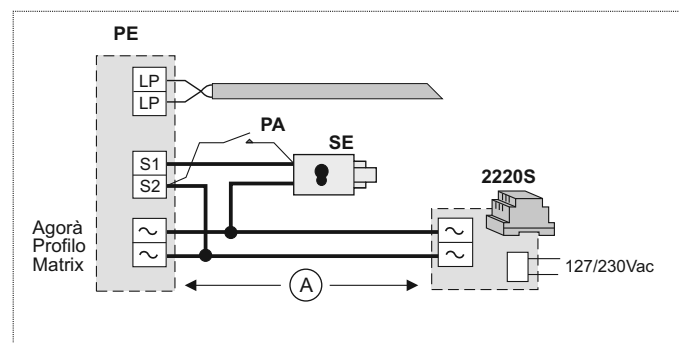
<sup>(1)</sup> Articles to be programmed

<sup>(2)</sup> Rain shelters are used in replacement of back boxes.

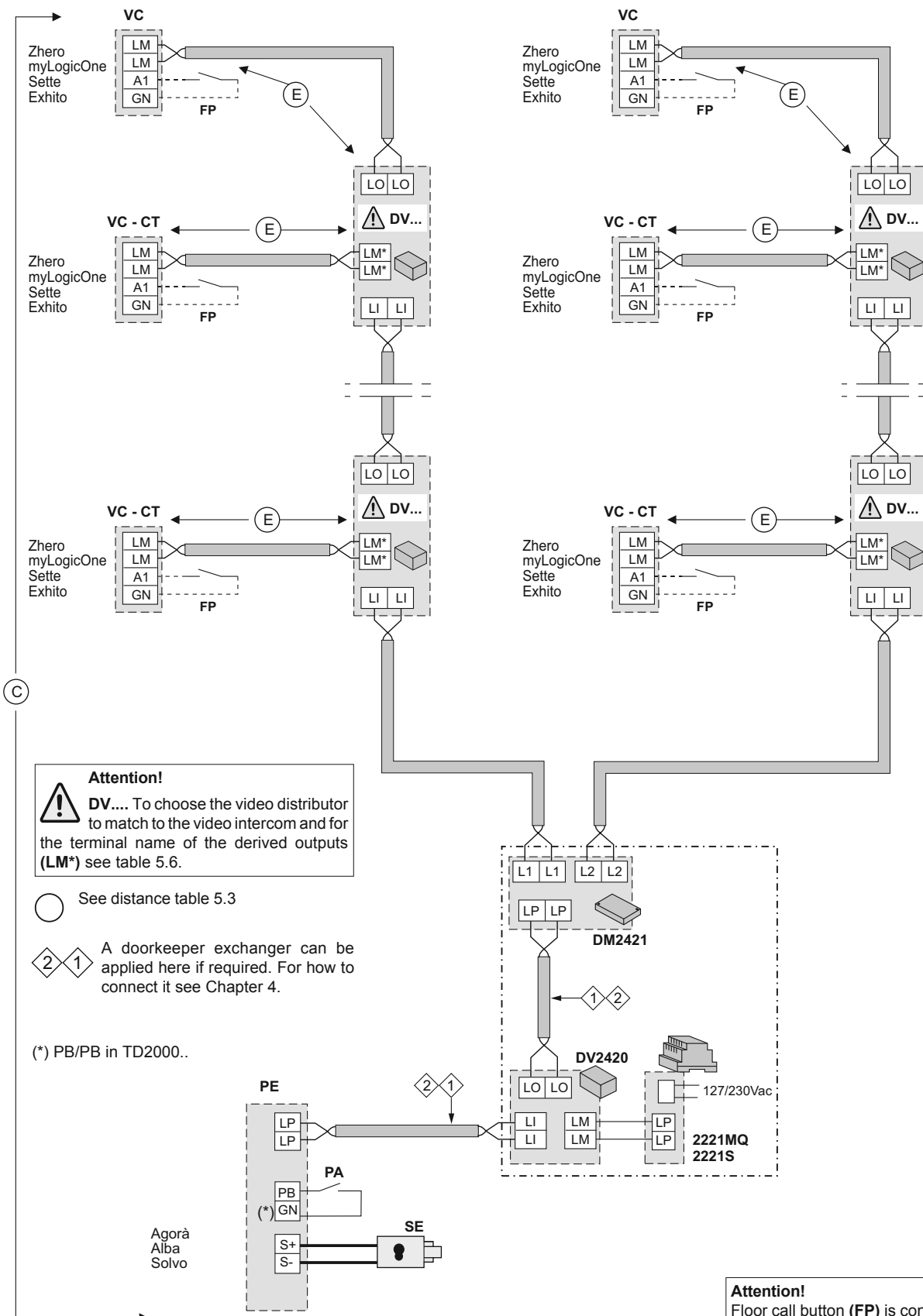
<sup>(3)</sup> Articles not supplied by ACI Farfisa.

## Installation notes.

- For maximum users number see table 5.1.
- For the choos and cross section and installation of the wires see table 5.3.
- For the correct operation of the system, jumper **J1** of all the video distributors must be left in position **2-3** (open line). The line impedance is determined by the video intercom connected to the **LO** output of the last video distributor; if this output is not connected close it by positioning jumper **J1** appropriately. The line must not remain open.
- We recommend to install all articles framed with a broken line in the same switchboard.
- Using TRADITIONAL external stations (with 2220S), apply the diagram below:



MULTI-WAY SYSTEM CONNECTED TO 1 AUDIO-VIDEO DOOR STATION AND DIVISION IN 2 RISERS



**Attention!**  
 DV... To choose the video distributor to match to the video intercom and for the terminal name of the derived outputs (LM\*) see table 5.6.

○ See distance table 5.3

◊ 2 1 A doorkeeper exchanger can be applied here if required. For how to connect it see Chapter 4.

(\*) PB/PB in TD2000..

**Attention!**  
 Floor call button (FP) is connected between terminals A1/A1 for ZH1252W and SE4252.

## MULTI-WAY SYSTEM CONNECTED TO ONE TRADITIONAL AUDIO-VIDEO EXTERNAL DOOR STATION, ADDITIONAL SURVEILLANCE CAMERA AND ACTIVATION OF AUTOMATIC GATE BY MEANS OF ACTUATOR

### • Internal Stations: VIDEOINTERCOMS (VC)

series ZHERO			myLogicOne			SETTE			EXHITO			EXHITO			EXHITO		
...	ZH1262B	(1)	...	ML2002C	(1)	...	SE4252	(1)	...	EX3262C	(1)	...	EX3252C	(1)	...	EX352	(1)
...	ZH1262W	(1)	...	ML2083					...	WB3262		...	WB3252	(1)	...	EX362	(1)
...	ZH1252W	(1)	...	WA2160W					...	TA3160		...	TA3160		...	TA320	
...	TA1260		...	TA2160													

### • INTERCOMS (CT)

### • External Stations TRADITIONAL with Digital Encoder (PE)

series AGORA'		series PROFILO		series MATRIX	
1	VD2121CAG(L)-AD2121CAG(L) (1)	1	VD2120CPL-AD2120CPL	1	VD2120CMAS
...	AG100TS-AGL100TS (1)	1	CD2131PL÷CD2138PL (1)	1	CD2131MAS÷CD2134MAS (1)
...	AG21-AGL21	...	PL24S-PL228S (1)	...	MAS24S (1)
...	AG20-AGL20	...	PL20-PL50	...	MAS20
		...	PL72-PL73	...	MA72-MA73
		1	PL82÷PL89	1	MAS62-MAS63
		1	PL92÷PL99 (2)	1	MA92-MA93 (2)

### • External Stations TRADITIONAL with Digital Keyboard (PE)

series PROFILO		series MATRIX	
1	VD2120CPL-AD2120CPL	1	VD2120CMAS
1	TD2100PL (1)	1	TD2100MAS (1)
1	PL72	1	MA72
1	PL82	1	MAS62
1	PL92 (2)	1	MA92 (2)

### • Other articles

...	DV2421Q	Video distributor with 1 output
...	DV2424Q	Video distributor with 4 outputs
...	DV2422A (1)	Active video distributor with 2 outputs
1	2220S	Transformer
1	2221MQ - 2221S	Line power supply
1	DV2420	Line distributor
1	2281Q	Actuator module
1	TVT	Surveillance PAL analogic camera
...	FP (3)	Floor push-button (optional)
1	PA (3)	Door release button (optional)
1	SE (3)	Electric door lock (12Vac-1A)

... According to the number of users (max. 50).

(1) Articles to be programmed.

(2) Rain shelters are used in replacement of back boxes and hood covers.

(3) Articles not supplied by ACI Farfisa.

### Installation notes

- If you use more than 1 push-button modules (door station), you must power the name-plate LEDs of the additional modules with an 12Vac supplementary transformer.
- With this schematic a maximum of 50 internal stations can be used.
- For the cross section and installation of the wires see table 5.3.
- For the correct operation of the system, jumper J1 of all the video distributors must be left in position 2-3 (open line). The line impedance is determined by the video intercom connected to the LO output of the last video distributor; if this output is not connected close it by positioning jumper J1 appropriately. The line must not remain open.
- We recommend to install all articles framed with a broken line in the same switchboard.

### Programming

After all the connections have been made and the system powered up, proceed to programming the apparatus listed below in the order shown.



- Door stations:**
- First button address (encoder and additional button modules)
  - Enter the user names (digital keyboard)
  - Enable auxiliary camera management

- Internal stations:**
- User address (see chapter 2)
  - Activation of a button to enable the actuator (211 is 2281Q factory address).



### Possible extensions of the system

- Higher number of users.
- Internal stations in parallel in individual apartments.
- Increase the distance of the installation (using amplifiers).
- Application of actuators for various services.
- Application of one or more keeper exchangers.

### Control switching ON from the videointercoms



From each videointercom you can see the entrance by pressing  (or .

To switch on the surveillance camera, press:

-  again after lifting the handset (series Exhito);
-  and then "monitor" (series Zhero);
- "menu" and then "camera" (series myLogicOne).

The control switching ON is not enabled when another videointercom is switched on.

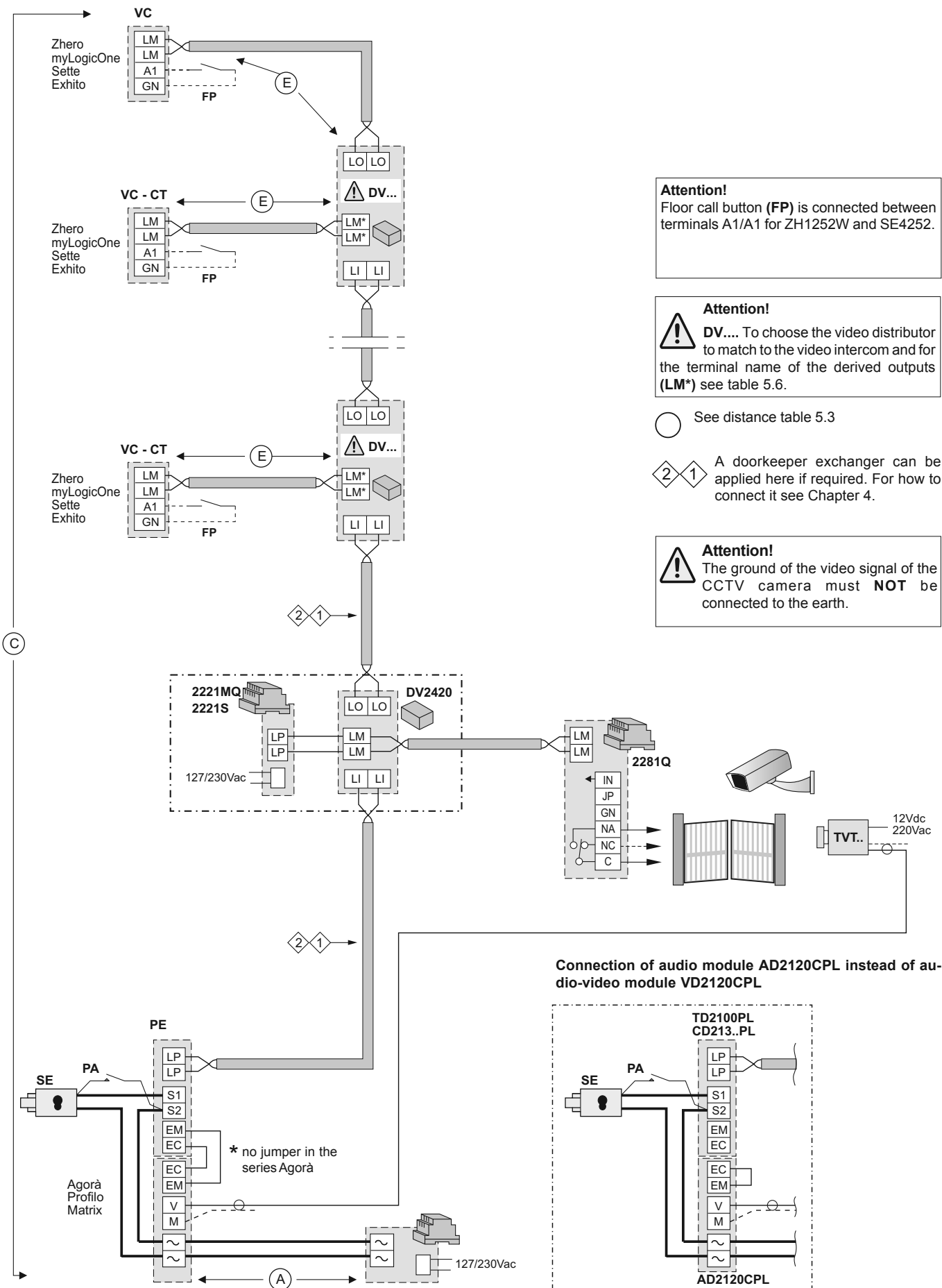
### Operating mode.

The internal station will receive the call and, if the called user is a videointercom, the display will turn ON and show the entrance. Lift the handset (or press ) to start the conversation and press the button  to actuate the door lock.

To actuate the automatic gate, press the key chosen during the programming.

For more detailed information on operation see the description of the different products (chapters 2, 3 and 4).

MULTI-WAY SYSTEM CONNECTED TO ONE TRADITIONAL AUDIO-VIDEO EXTERNAL DOOR STATION, ADDITIONAL SURVEILLANCE CAMERA AND ACTIVATION OF AUTOMATIC GATE BY MEANS OF ACTUATOR



**Attention!**  
Floor call button (FP) is connected between terminals A1/A1 for ZH1252W and SE4252.

**Attention!**  
DV.... To choose the video distributor to match to the video intercom and for the terminal name of the derived outputs (LM\*) see table 5.6.

○ See distance table 5.3

◇ 2 1 A doorkeeper exchanger can be applied here if required. For how to connect it see Chapter 4.

**Attention!**  
The ground of the video signal of the CCTV camera must **NOT** be connected to the earth.

## MULTI-WAY SYSTEM CONNECTED TO ONE POWERED FROM THE BUS AUDIO-VIDEO EXTERNAL DOOR STATION, ADDITIONAL SURVEILLANCE CAMERA AND ACTIVATION OF AUTOMATIC GATE

### ● Internal Stations: VIDEOINTERCOMS (VC)

series ZHERO			myLogicOne			SETTE			EXHITO			EXHITO			EXHITO		
...	ZH1262B (1)	...	ML2002C (1)	...	SE4252 (1)	...	EX3262C (1)	...	EX3252C (1)	...	EX352 (1)	...	EX362 (1)	...	TA320		
...	ZH1262W (1)	...	ML2083	...		...	WB3262	...	WB3252 (1)	...	EX362 (1)	...	EX362 (1)	...	TA320		
...	ZH1252W (1)	...	WA2160W	...		...	TA3160	...	TA3160	...	TA320	...	TA320	...	TA320		
...	TA1260	...	TA2160	...		...		...		...		...		...			

### ● INTERCOMS (CT)

### ● External Stations POWERED FROM THE BUS with Digital Encoder (PE)

#### series ALBA

1	CV2124AB-CA2124AB (1)	...	AB61-AB63
...	CT2138AB	...	AB71-AB73
...	AB21	...	EC733
...	AB20		
...	AB00-AB50		
...	SC1÷SC3		
...	AB91÷AB96 (2)		

### ● External Stations POWERED FROM THE BUS with Digital Keyboard (PE)

#### series SOLVO

1	TD2000-TD2000A-TD2000R-TD2000RA (1)
...	FP2000
1	290S//0 (2)

### ● Other articles

...	DV2421Q	Video distributor with 1 output
...	DV2424Q	Video distributor with 4 outputs
...	DV2422A (1)	Active video distributor with 2 outputs
1	2221MQ - 2221S	Line power supply
1	DV2420	Line distributor
1	VM2521 (1)	Video Modulator
1	TVT	Surveillance PAL analog camera
...	FP (3)	Floor push-button (optional)
1	PA (3)	Door release button (optional)
1	SE (3)	Electric door lock (12Vac-1A)

... According to the number of users (max. 40).

(1) Articles to be programmed.

(2) Rain shelters are used in replacement of back boxes and hood covers.

(3) Articles not supplied by ACI Farfisa.

### Installation notes

- For the cross section and installation of the wires see table 5.3.
- For the correct operation of the system, jumper J1 of all the video distributors must be left in position 2-3 (open line). The line impedance is determined by the video intercom connected to the LO output of the last video distributor; if this output is not connected close it by positioning jumper J1 appropriately. The line must not remain open.
- We recommend to install all articles framed with a broken line in the same switchboard.
- J13 is the connector for Alba auxiliary relay contacts (for automatic gate).

### Programming

After all the connections have been made and the system powered up, proceed to programming the apparatus listed below in the order shown.

**Door stations:**

- First button address
- Enter the user names (digital keyboard)
- Enable auxiliary camera management (firmware version >= PDX1)

**Internal stations:**

- User address (see chapter 2)
- Activation of a button to command automatic gate



**VM2521:**

- V1-M1 input address (see chapter 4)



### Possible extensions of the system

- Internal stations in parallel in individual apartments.
- Increase the distance of the installation (using amplifiers).
- Application of actuators for various services.
- Application of one or more keeper exchangers.

### Control switching ON from the videointercoms



From each videointercom you can see the entrance by pressing  (or ).

To switch on the surveillance camera, press:

-  again after lifting the handset (series Exhito);
-  and then "monitor" (series Zhero);
- "menu" and then "camera" (series myLogicOne).

The control switching ON is not enabled when another videointercom is switched on.

### Operating mode.

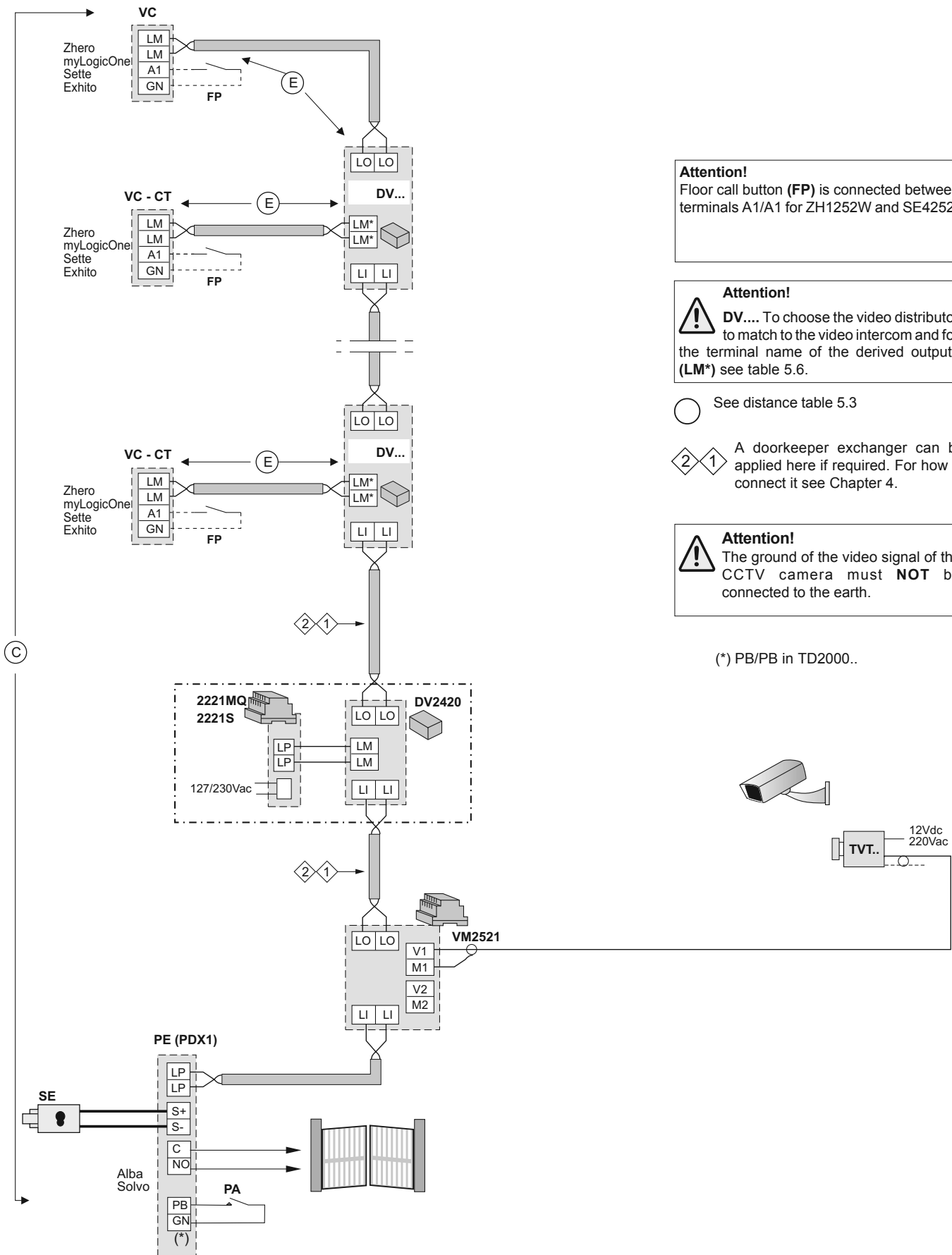
The internal station will receive the call and, if the called user is a videointercom, the display will turn ON and show the entrance. Lift the handset (or press ) to start the conversation and press the button  to actuate the door lock.

To actuate the automatic gate, press the key chosen during the programming.

For more detailed information on operation see the description of the different products (chapters 2, 3A and 4).



MULTI-WAY SYSTEM CONNECTED TO ONE POWERED FROM THE BUS AUDIO-VIDEO EXTERNAL DOOR STATION, ADDITIONAL SURVEILLANCE CAMERA AND ACTIVATION OF AUTOMATIC GATE



**Attention!**  
Floor call button (FP) is connected between terminals A1/A1 for ZH1252W and SE4252.

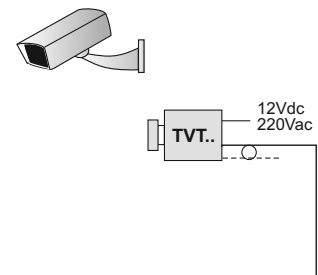
**Attention!**  
DV.... To choose the video distributor to match to the video intercom and for the terminal name of the derived outputs (LM\*) see table 5.6.

○ See distance table 5.3

⬡ 2 1 A doorkeeper exchanger can be applied here if required. For how to connect it see Chapter 4.

**Attention!**  
The ground of the video signal of the CCTV camera must **NOT** be connected to the earth.

(\*) PB/PB in TD2000..



## MULTI-WAY SYSTEM CONNECTED TO 2 AUDIO-VIDEO DOOR STATIONS ONE OF WHICH IS ONLY AUDIO

## ● Internal Stations: VIDEOINTERCOMS (VC)

series ZHERO	myLogicOne	SETTE	EXHITO	EXHITO	EXHITO
... ZH1262B <sup>(1)</sup>	... ML2002C <sup>(1)</sup>	... SE4252 <sup>(1)</sup>	... EX3262C <sup>(1)</sup>	... EX3252C <sup>(1)</sup>	... EX352 <sup>(1)</sup>
... ZH1262W <sup>(1)</sup>	... ML2083		... WB3262	... WB3252 <sup>(1)</sup>	... EX362 <sup>(1)</sup>
... ZH1252W <sup>(1)</sup>	... WA2160W		... TA3160	... TA3160	... TA320
... TA1260	... TA2160				

## ● INTERCOMS (CT)

## ● External Stations POWERED FROM THE BUS with Digital Encoder (PE)

series AGORA'	series ALBA
... VD2101AGL-AD2101AGL <sup>(1)</sup>	... CV2124AB-CA2124AB <sup>(1)</sup>
... AGL21	... CT2138AB
... AGL20	... AB21
	... AB20
	... AB00-AB50
	... SC1÷SC3
	... AB91÷AB96 <sup>(2)</sup>
	... AB61-AB63
	... AB71-AB73
	... EC733

## ● External Stations POWERED FROM THE BUS with Digital Keyboard (PE)

## series SOLVO

... TD2000-TD2000R-TD2000A-TD2000RA <sup>(1)</sup>
... FP2000
... 290S/0 <sup>(2)</sup>

## ● External Stations TRADITIONAL with Digital Encoder (PE)

series AGORA'	series PROFILO	series MATRIX
... VD2121CAG(L)-AD2121CAG(L) <sup>(1)</sup>	... VD2120CPL-AD2120CPL	... VD2120CMAS-AD2110MAS
... AG100TS-AGL100TS <sup>(1)</sup>	... CD2131PL÷CD2138PL <sup>(1)</sup>	... CD2131MAS÷CD2134MAS <sup>(1)</sup>
... AG21-AGL21	... PL24S-PL228S <sup>(1)</sup>	... MAS24S <sup>(1)</sup>
... AG20-AGL20	... PL20-PL50	... MAS20
... 2220S	... PL72-PL73	... MA72-MA73
... PRS210	... PL82÷PL89	... MAS62-MAS63
	... PL92÷PL99 <sup>(2)</sup>	... MA92-MA93 <sup>(2)</sup>
	... 2220S	... 2220S
	... PRS210	... PRS210

## ● External Stations TRADITIONAL with Digital Keyboard (PE)

series PROFILO	series MATRIX
... VD2120CPL-AD2120CPL	... VD2120CMAS-AD2110MAS
... TD2100PL <sup>(1)</sup>	... TD2100MAS <sup>(1)</sup>
... PL72	... MA72
... PL82	... MAS62
... PL92 <sup>(2)</sup>	... MA92 <sup>(2)</sup>
... 2220S	... 2220S

## ● Other Articles

... DV2421Q	Video distributor with 1 output
... DV2424Q	Video distributor with 4 outputs
... DV2422A <sup>(1)</sup>	Active video distributor with 2 outputs
... 2221MQ - 2221S	Line power supply
... DV2420	Line distributor
... FP <sup>(3)</sup>	Floor push button (optional)
... PA <sup>(3)</sup>	Door release button (optional)
... SE <sup>(3)</sup>	Electrical door lock(12Vac-1A)

... According to the number of users and external stations

<sup>(1)</sup> Articles to be programmed

<sup>(2)</sup> Rain shelters are used in replacement of back boxes.

<sup>(3)</sup> Articles not supplied by ACI Farfisa.

## Installation notes.

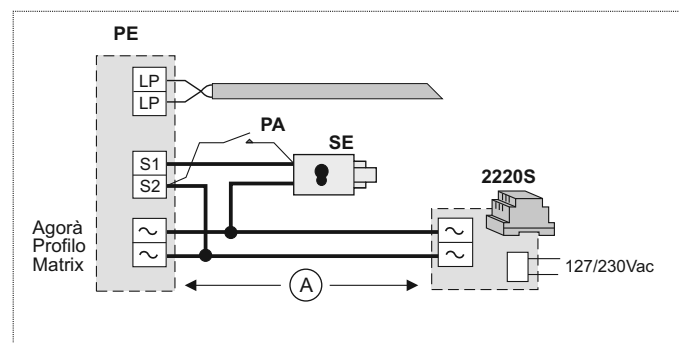
- For maximum users number see table 5.1.

- For the choos and cross section and installation of the wires see table 5.3.

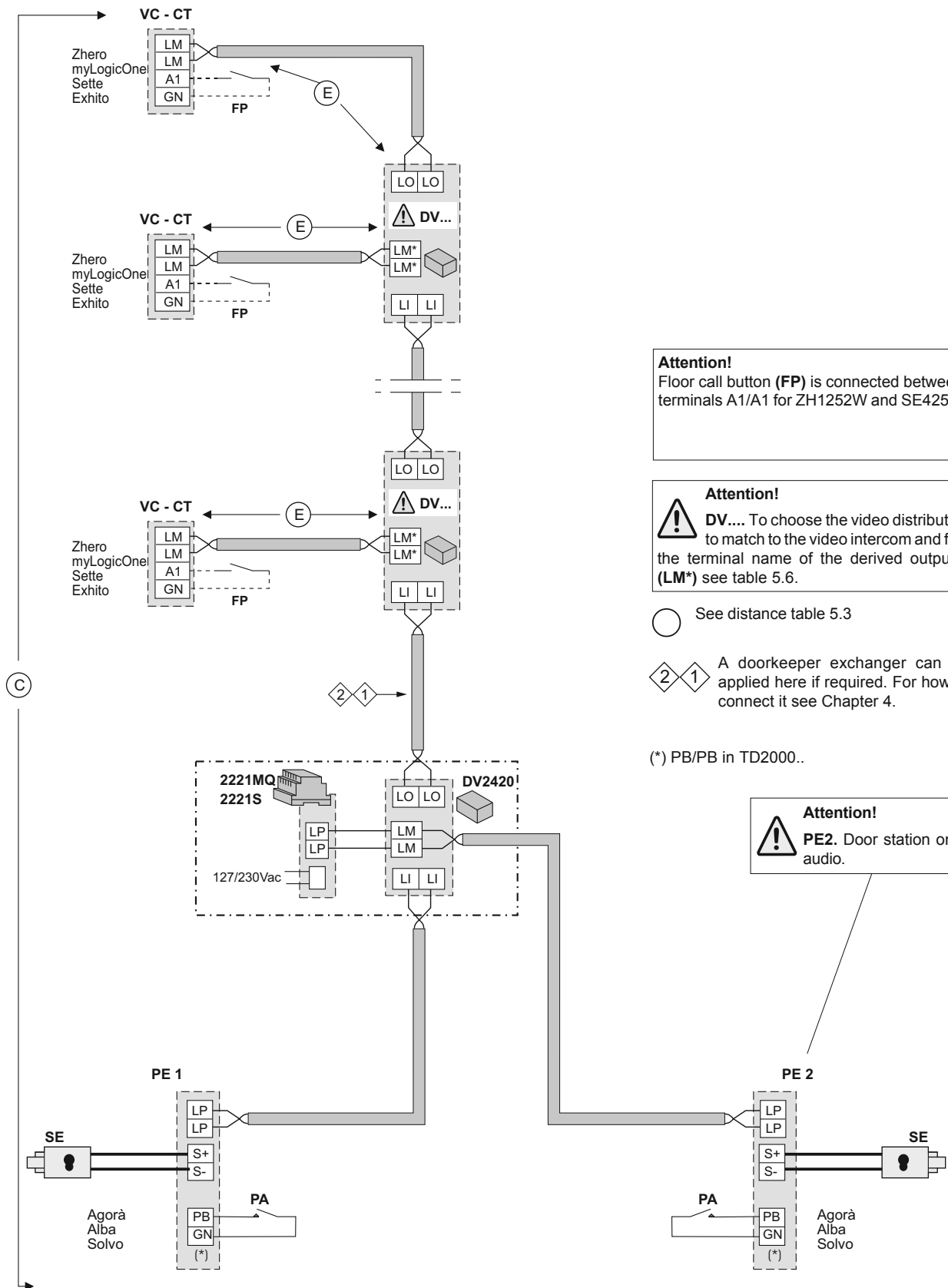
- For the correct operation of the system, jumper **J1** of all the video distributors must be left in position **2-3** (open line). The line impedance is determined by the video intercom connected to the **LO** output of the last video distributor; if this output is not connected close it by positioning jumper **J1** appropriately. The line must not remain open.

- We recommend to install all articles framed with a broken line in the same switchboard.

- Using TRADITIONAL external stations (with 2220S), apply the diagram below:



MULTI-WAY SYSTEM CONNECTED TO 2 AUDIO-VIDEO DOOR STATIONS ONE OF WHICH IS ONLY AUDIO (PE2)



**Attention!**  
 Floor call button (FP) is connected between terminals A1/A1 for ZH1252W and SE4252.

**Attention!**  
**DV....** To choose the video distributor to match to the video intercom and for the terminal name of the derived outputs (**LM\***) see table 5.6.

○ See distance table 5.3

◇ 2 ◇ 1 A doorkeeper exchanger can be applied here if required. For how to connect it see Chapter 4.

(\*) PB/PB in TD2000..

**Attention!**  
**PE2.** Door station only audio.

## MULTI-WAY SYSTEM CONNECTED TO 2 AUDIO-VIDEO DOOR STATIONS

## ● Internal Stations: VIDEOINTERCOMS (VC)

series ZHERO	myLogicOne	SETTE	EXHITO	EXHITO	EXHITO
... ZH1262B (1)	... ML2002C (1)	... SE4252 (1)	... EX3262C (1)	... EX3252C (1)	... EX352 (1)
... ZH1262W (1)	... ML2083		... WB3262	... WB3252 (1)	... EX362 (1)
... ZH1252W (1)	... WA2160W		... TA3160	... TA3160	... TA320
... TA1260	... TA2160				

## ● External Stations POWERED FROM THE BUS with Digital Encoder (PE)

series AGORA'	series ALBA
... VD2101AGL-AD2101AGL (1)	... CV2124AB-CA2124AB (1)
... AGL21	... CT2138AB
... AGL20	... AB21
	... AB20
	... AB00-AB50
	... SC1÷SC3
	... AB91÷AB96 (2)
	... AB61-AB63
	... AB71-AB73
	... EC733

## ● External Stations POWERED FROM THE BUS with Digital Keyboard (PE)

## series SOLVO

... TD2000-TD2000R-TD2000A-TD2000RA (1)
... FP2000
... 290S/0 (2)

## ● External Stations TRADITIONAL with Digital Encoder (PE)

series AGORA'	series PROFILO	series MATRIX
... VD2121CAG(L)-AD2121CAG(L) (1)	... VD2120CPL-AD2120CPL	... VD2120CMAS-AD2110MAS
... AG100TS-AGL100TS (1)	... CD2131PL÷CD2138PL (1)	... CD2131MAS÷CD2134MAS (1)
... AG21-AGL21	... PL24S-PL228S (1)	... MAS24S (1)
... AG20-AGL20	... PL20-PL50	... MAS20
... 2220S	... PL72-PL73	... MA72-MA73
... PRS210	... PL82÷PL89	... MAS62-MAS63
	... PL92÷PL99 (2)	... MA92-MA93 (2)
	... 2220S	... 2220S
	... PRS210	... PRS210

## ● External Stations TRADITIONAL with Digital Keyboard (PE)

series PROFILO	series MATRIX
... VD2120CPL-AD2120CPL	... VD2120CMAS-AD2110MAS
... TD2100PL (1)	... TD2100MAS (1)
... PL72	... MA72
... PL82	... MAS62
... PL92 (2)	... MA92 (2)
... 2220S	... 2220S

## ● Other Articles

... DV2421Q	Video distributor with 1 output
... DV2424Q	Video distributor with 4 outputs
... DV2422A (1)	Active video distributor with 2 outputs
... DM2421 (1)	Line distributor
... 2221MQ - 2221S	Line power supply
... DV2420	Line distributor
... FP (3)	Floor push button (optional)
... PA (3)	Door release button (optional)
... SE (3)	Electrical door lock(12Vac-1A)

... According to the number of users and external stations

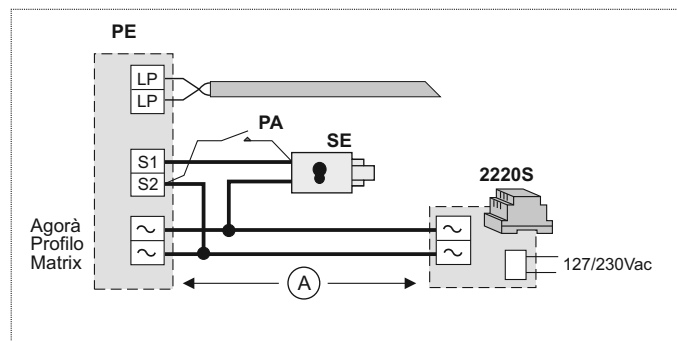
(1) Articles to be programmed

(2) Rain shelters are used in replacement of back boxes.

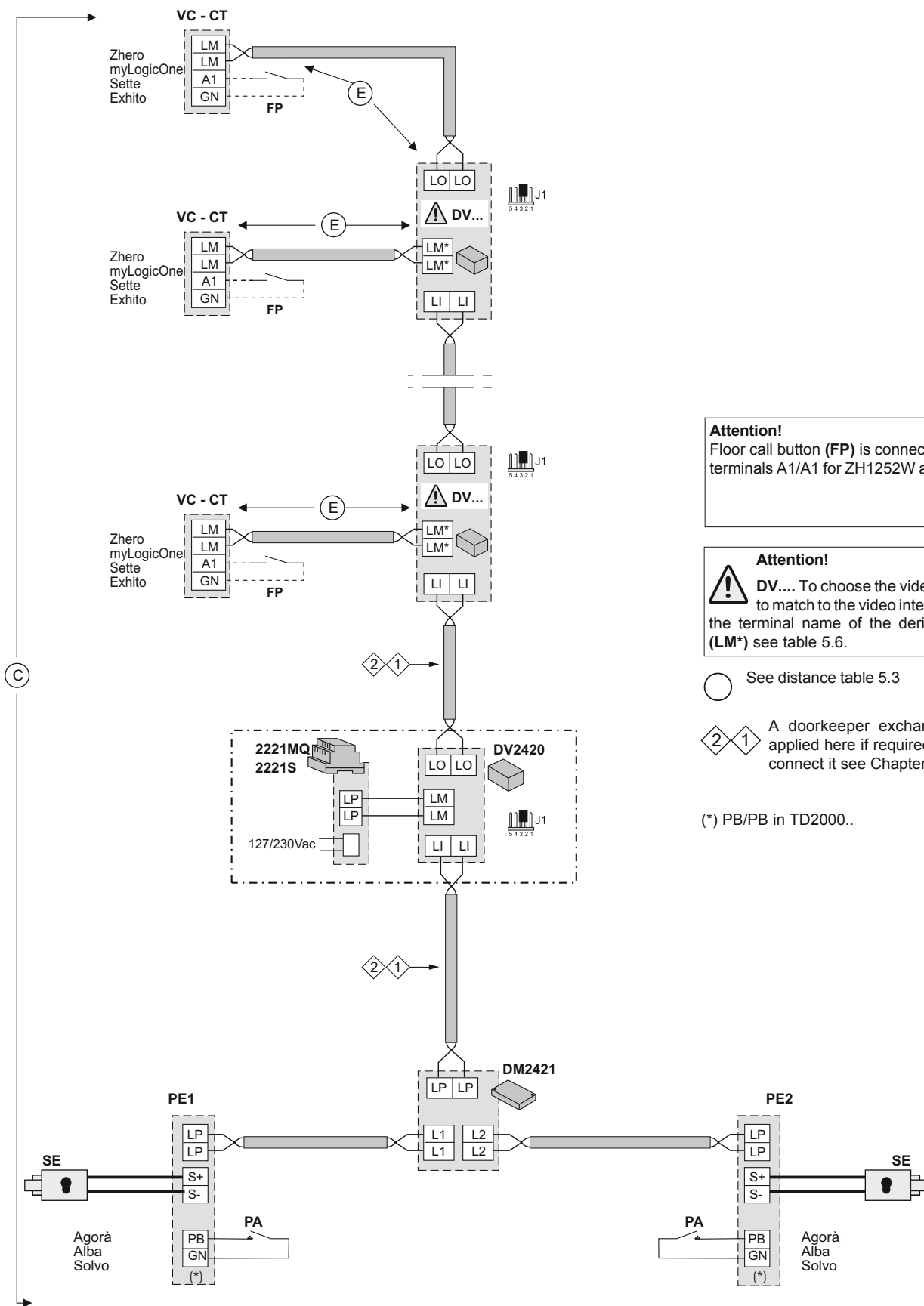
(3) Articles not supplied by ACI Farfisa.

## Installation notes.

- For maximum users number see table 5.1.
- For the choos and cross section and installation of the wires see table 5.3.
- For the correct operation of the system, jumper **J1** of all the video distributors must be left in position **2-3** (open line). The line impedance is determined by the video intercom connected to the **LO** output of the last video distributor; if this output is not connected close it by positioning jumper **J1** appropriately. The line must not remain open.
- We recommend to install all articles framed with a broken line in the same switchboard.
- Using TRADITIONAL external stations (with 2220S), apply the diagram below:



MULTI-WAY SYSTEM CONNECTED TO 2 AUDIO-VIDEO DOOR STATIONS



**Attention!**  
Floor call button (FP) is connected between terminals A1/A1 for ZH1252W and SE4252.

**Attention!**  
DV... To choose the video distributor to match to the video intercom and for the terminal name of the derived outputs (LM\*) see table 5.6.

○ See distance table 5.3

◇◇ A doorkeeper exchanger can be applied here if required. For how to connect it see Chapter 4.

(\*) PB/PB in TD2000..

## MULTI-WAY SYSTEM CONNECTED TO MAX 4 AUDIO-VIDEO MAIN COMMON DOOR STATIONS AND DIVISION IN MAX 4 INDEPENDENT RISERS WITHOUT SECONDARY DOOR STATIONS

### ● Internal Stations: VIDEOINTERCOMS (VC)

● Internal Stations: VIDEOINTERCOMS (VC)			● INTERCOMS (CT)		
<i>series ZHERO</i>	<i>myLogicOne</i>	<i>SETTE</i>	<i>EXHITO</i>	<i>EXHITO</i>	<i>EXHITO</i>
... ZH1262B <sup>(1)</sup>	... ML2002C <sup>(1)</sup>	... SE4252 <sup>(1)</sup>	... EX3262C <sup>(1)</sup>	... EX3252C <sup>(1)</sup>	... EX352 <sup>(1)</sup>
... ZH1262W <sup>(1)</sup>	... ML2083		... WB3262	... WB3252 <sup>(1)</sup>	... EX362 <sup>(1)</sup>
... ZH1252W <sup>(1)</sup>	... WA2160W		... TA3160	... TA3160	... TA320
... TA1260	... TA2160				

### ● External Stations POWERED FROM THE BUS with Digital Encoder (PE)

<i>series AGORA'</i>	<i>series ALBA</i>
... VD2101AGL-AD2101AGL <sup>(1)</sup>	... CV2124AB-CA2124AB <sup>(1)</sup>
... AGL21	... CT2138AB
... AGL20	... AB21
	... AB20
	... AB00-AB50
	... SC1÷SC3
	... AB91÷AB96 <sup>(2)</sup>
	... AB61-AB63
	... AB71-AB73
	... EC733

### ● External Stations POWERED FROM THE BUS with Digital Keyboard (PE)

#### *series SOLVO*

... TD2000-TD2000R-TD2000A-TD2000RA <sup>(1)</sup>
... FP2000
... 290S/0 <sup>(2)</sup>

### ● External Stations TRADITIONAL with Digital Encoder (PE)

<i>series AGORA'</i>	<i>series PROFILO</i>	<i>series MATRIX</i>
... VD2121CAG(L)-AD2121CAG(L) <sup>(1)</sup>	... VD2120CPL-AD2120CPL	... VD2120CMAS-AD2110MAS
... AG100TS-AGL100TS <sup>(1)</sup>	... CD2131PL÷CD2138PL <sup>(1)</sup>	... CD2131MAS÷CD2134MAS <sup>(1)</sup>
... AG21-AGL21	... PL24S-PL228S <sup>(1)</sup>	... MAS24S <sup>(1)</sup>
... AG20-AGL20	... PL20-PL50	... MAS20
... 2220S	... PL72-PL73	... MA72-MA73
... PRS210	... PL82÷PL89	... MAS62-MAS63
	... PL92÷PL99 <sup>(2)</sup>	... MA92-MA93 <sup>(2)</sup>
	... 2220S	... 2220S
	... PRS210	... PRS210

### ● External Stations TRADITIONAL with Digital Keyboard (PE)

<i>series PROFILO</i>	<i>series MATRIX</i>
... VD2120CPL-AD2120CPL	... VD2120CMAS-AD2110MAS
... TD2100PL <sup>(1)</sup>	... TD2100MAS <sup>(1)</sup>
... PL72	... MA72
... PL82	... MAS62
... PL92 <sup>(2)</sup>	... MA92 <sup>(2)</sup>
... 2220S	... 2220S

### ● Other Articles

... DV2421Q	Video distributor with 1 output
... DV2424Q	Video distributor with 4 outputs
... DV2422A <sup>(1)</sup>	Active video distributor with 2 outputs
... 2231Q <sup>(1)</sup>	Line buffer
... DM2444 <sup>(1)</sup>	4 IN/4 OUTPUT line distributor
... 2221MQ - 2221S	Line power supply
... DV2420	Line distributor
... FP <sup>(3)</sup>	Floor push button (optional)
... PA <sup>(3)</sup>	Door release button (optional)
... SE <sup>(3)</sup>	Electrical door lock(12Vac-1A)

... According to the number of users and external stations

<sup>(1)</sup> Articles to be programmed

<sup>(2)</sup> Rain shelters are used in replacement of back boxes.

<sup>(3)</sup> Articles not supplied by ACI Farfisa.

### Installation notes.

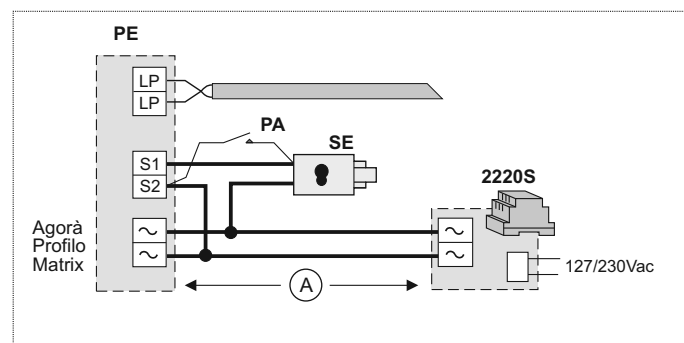
- For maximum users number see table 5.1.

- For the choos and cross section and installation of the wires see table 5.3.

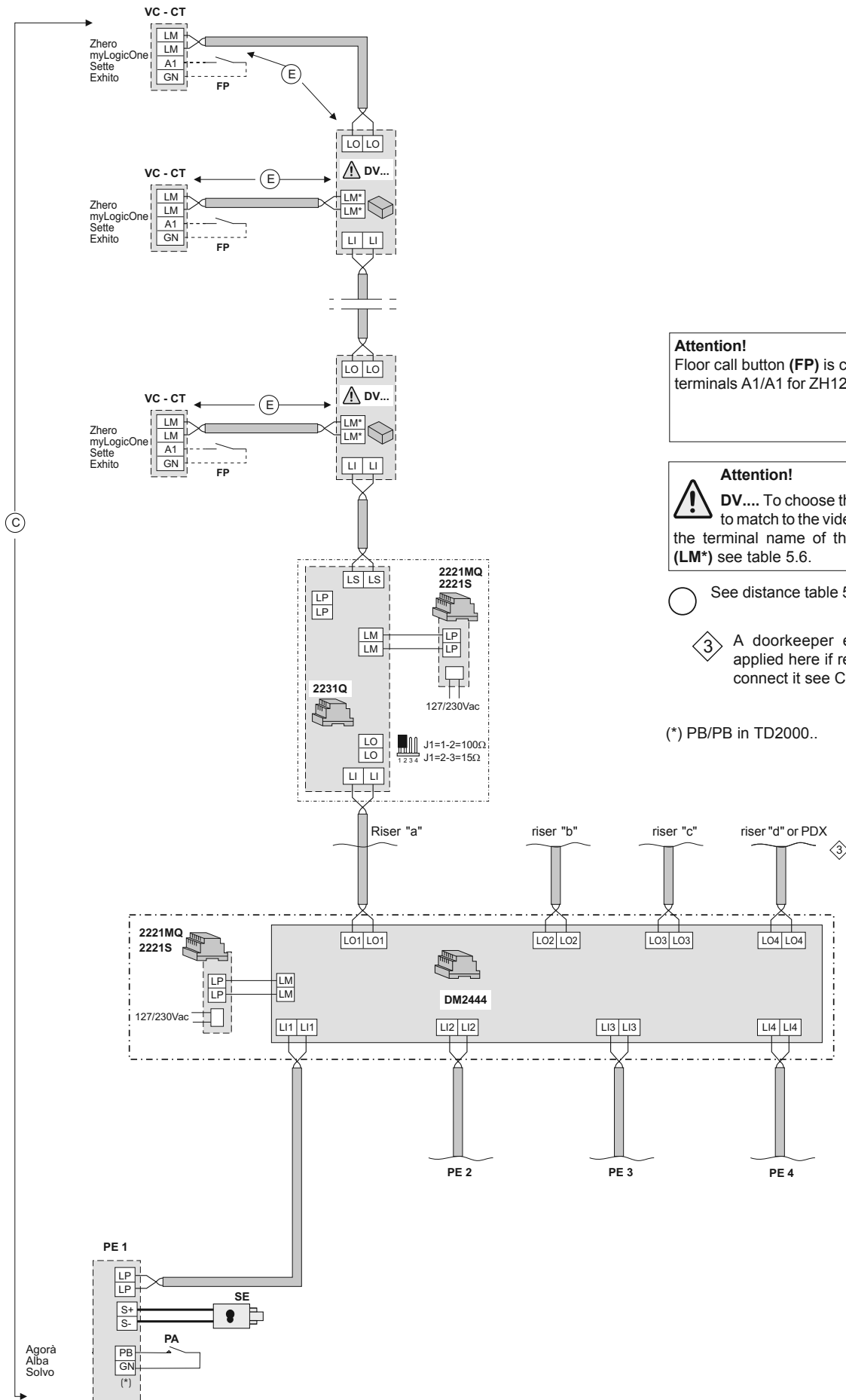
- For the correct operation of the system, jumper **J1** of all the video distributors must be left in position **2-3** (open line). The line impedance is determined by the video intercom connected to the **LO** output of the last video distributor; if this output is not connected close it by positioning jumper **J1** appropriately. The line must not remain open.

- We recommend to install all articles framed with a broken line in the same switchboard.

- Using TRADITIONAL external stations (with 2220S), apply the diagram below:



**MULTI-WAY SYSTEM CONNECTED TO MAX 4 AUDIO-VIDEO MAIN COMMON DOOR STATIONS AND DIVISION IN MAX 4 INDEPENDENT RISERS WITHOUT SECONDARY DOOR STATIONS**



**Attention!**  
Floor call button (FP) is connected between terminals A1/A1 for ZH1252W and SE4252.

**Attention!**  
**DV....** To choose the video distributor to match to the video intercom and for the terminal name of the derived outputs (**LM\***) see table 5.6.

○ See distance table 5.3

◇ 3 A doorkeeper exchanger can be applied here if required. For how to connect it see Chapter 4.

(\*) PB/PB in TD2000..

## MULTI-WAY SYSTEM CONNECTED TO MAX 4 AUDIO-VIDEO MAIN COMMON DOOR STATIONS AND DIVISION IN MAX 4 RISERS WITHOUT SECONDARY DOOR STATIONS

### ● Internal Stations: VIDEOINTERCOMS (VC)

● Internal Stations: VIDEOINTERCOMS (VC)			● INTERCOMS (CT)		
<b>series ZHERO</b>	<b>myLogicOne</b>	<b>SETTE</b>	<b>EXHITO</b>	<b>EXHITO</b>	<b>EXHITO</b>
... ZH1262B <sup>(1)</sup>	... ML2002C <sup>(1)</sup>	... SE4252 <sup>(1)</sup>	... EX3262C <sup>(1)</sup>	... EX3252C <sup>(1)</sup>	... EX352 <sup>(1)</sup>
... ZH1262W <sup>(1)</sup>	... ML2083		... WB3262	... WB3252 <sup>(1)</sup>	... EX362 <sup>(1)</sup>
... ZH1252W <sup>(1)</sup>	... WA2160W		... TA3160	... TA3160	... TA320
... TA1260	... TA2160				

### ● External Stations POWERED FROM THE BUS with Digital Encoder (PE)

<b>series AGORA'</b>	<b>series ALBA</b>
... VD2101AGL-AD2101AGL <sup>(1)</sup>	... CV2124AB-CA2124AB <sup>(1)</sup>
... AGL21	... CT2138AB
... AGL20	... AB61-AB63
	... AB71-AB73
	... EC733
	... AB21
	... AB20
	... AB00-AB50
	... SC1÷SC3
	... AB91÷AB96 <sup>(2)</sup>

### ● External Stations POWERED FROM THE BUS with Digital Keyboard (PE)

#### series SOLVO

... TD2000-TD2000R-TD2000A-TD2000RA <sup>(1)</sup>
... FP2000
... 290S/0 <sup>(2)</sup>

### ● External Stations TRADITIONAL with Digital Encoder (PE)

<b>series AGORA'</b>	<b>series PROFILO</b>	<b>series MATRIX</b>
... VD2121CAG(L)-AD2121CAG(L) <sup>(1)</sup>	... VD2120CPL-AD2120CPL	... VD2120CMAS-AD2110MAS
... AG100TS-AGL100TS <sup>(1)</sup>	... CD2131PL÷CD2138PL <sup>(1)</sup>	... CD2131MAS÷CD2134MAS <sup>(1)</sup>
... AG21-AGL21	... PL24S-PL228S <sup>(1)</sup>	... MAS24S <sup>(1)</sup>
... AG20-AGL20	... PL20-PL50	... MAS20
... 2220S	... PL72-PL73	... MA72-MA73
... PRS210	... PL82÷PL89	... MAS62-MAS63
	... PL92÷PL99 <sup>(2)</sup>	... MA92-MA93 <sup>(2)</sup>
	... 2220S	... 2220S
	... PRS210	... PRS210

### ● External Stations TRADITIONAL with Digital Keyboard (PE)

<b>series PROFILO</b>	<b>series MATRIX</b>
... VD2120CPL-AD2120CPL	... VD2120CMAS-AD2110MAS
... TD2100PL <sup>(1)</sup>	... TD2100MAS <sup>(1)</sup>
... PL72	... MA72
... PL82	... MAS62
... PL92 <sup>(2)</sup>	... MA92 <sup>(2)</sup>
... 2220S	... 2220S

### ● Other Articles

... DV2421Q	Video distributor with 1 output
... DV2424Q	Video distributor with 4 outputs
... DV2422A <sup>(1)</sup>	Active video distributor with 2 outputs
... DM2444 <sup>(1)</sup>	4 IN/4 OUTPUT line distributor
... 2221MQ - 2221S	Line power supply
... DV2420	Line distributor
... FP <sup>(3)</sup>	Floor push button (optional)
... PA <sup>(3)</sup>	Door release button (optional)
... SE <sup>(3)</sup>	Electrical door lock(12Vac-1A)

... According to the number of users and external stations

<sup>(1)</sup> Articles to be programmed

<sup>(2)</sup> Rain shelters are used in replacement of back boxes.

<sup>(3)</sup> Articles not supplied by ACI Farfisa.

### Installation notes.

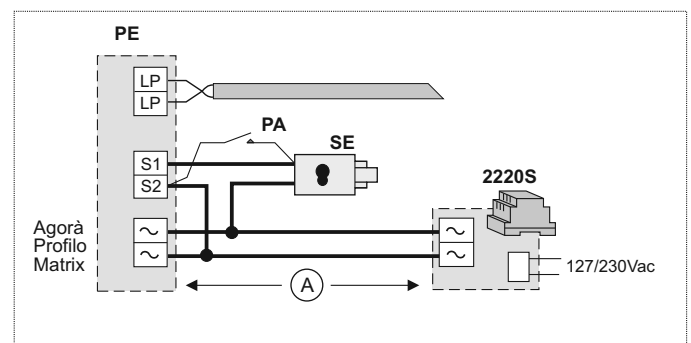
- For maximum users number see table 5.1.

- For the choos and cross section and installation of the wires see table 5.3.

- For the correct operation of the system, jumper **J1** of all the video distributors must be left in position **2-3** (open line). The line impedance is determined by the video intercom connected to the **LO** output of the last video distributor; if this output is not connected close it by positioning jumper **J1** appropriately. The line must not remain open.

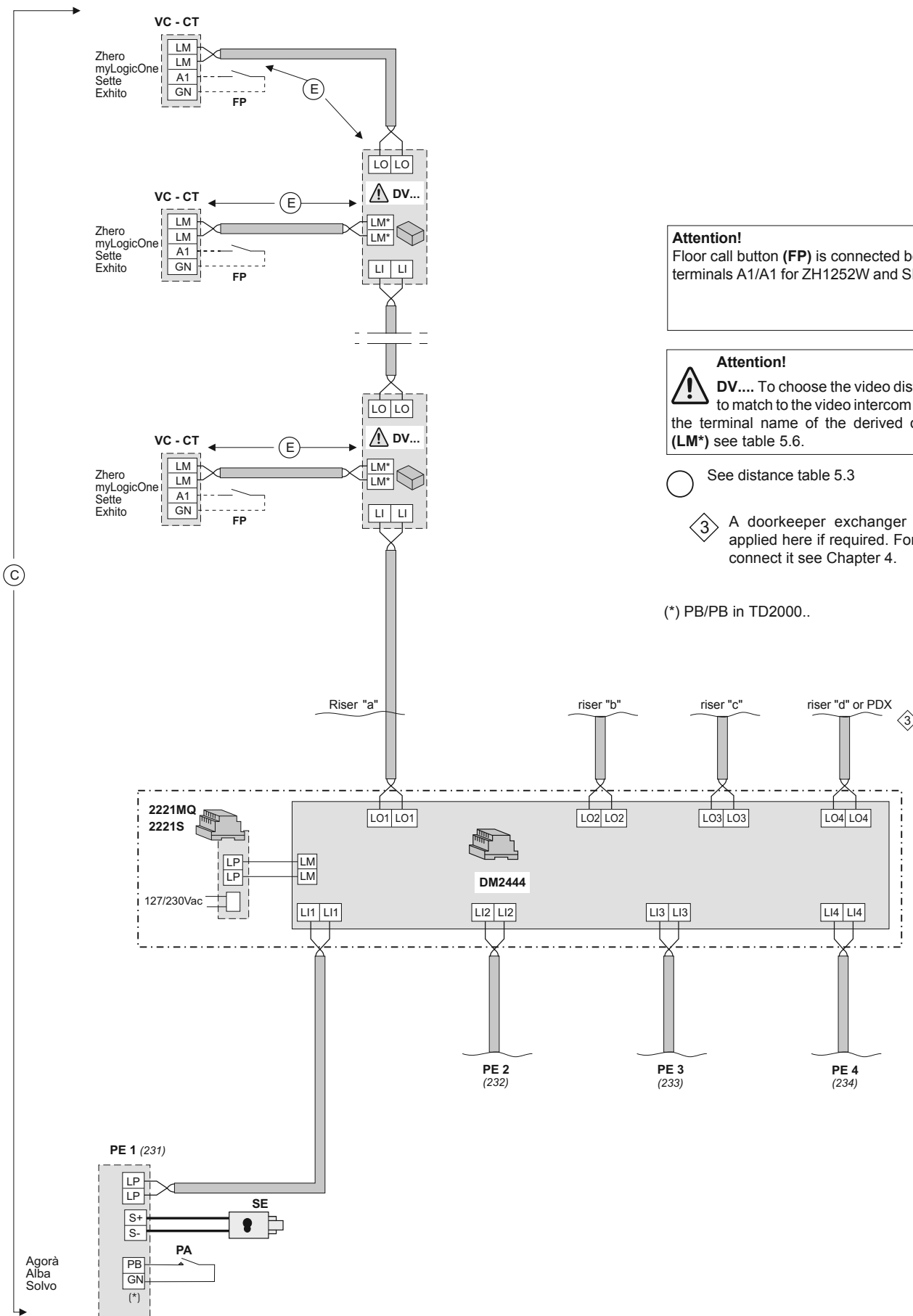
- We recommend to install all articles framed with a broken line in the same switchboard.

- Using TRADITIONAL external stations (with 2220S), apply the diagram below:





MULTI-WAY SYSTEM CONNECTED TO MAX 4 AUDIO-VIDEO MAIN COMMON DOOR STATIONS AND DIVISION IN MAX 4 RISERS WITHOUT SECONDARY DOOR STATIONS



**Attention!**  
Floor call button (FP) is connected between terminals A1/A1 for ZH1252W and SE4252.

**Attention!**  
DV... To choose the video distributor to match to the video intercom and for the terminal name of the derived outputs (LM\*) see table 5.6.

○ See distance table 5.3

◇ 3 A doorkeeper exchanger can be applied here if required. For how to connect it see Chapter 4.

(\*) PB/PB in TD2000..

**MULTI-WAY SYSTEM CONNECTED TO 1 AUDIO-VIDEO MAIN COMMON DOOR STATION AND DIVISION IN MORE RISERS WITH EACH 1 AUDIO-VIDEO SECONDARY DOOR STATION (staircase division). Applicable with Extended Range Duo.**

● Internal Stations: VIDEOINTERCOMS (VC)

series ZHERO			myLogicOne			SETTE			EXHITO			EXHITO			EXHITO		
...	ZH1262B (1)	...	ML2002C (1)	...	SE4252 (1)	...	EX3262C (1)	...	EX3252C (1)	...	EX352 (1)	...	EX362 (1)	...	TA320		
...	ZH1262W (1)	...	ML2083	...	WB3262	...	WB3252 (1)	...	TA3160	...	TA3160	...	TA3160	...	TA3160		
...	ZH1252W (1)	...	WA2160W	...	TA2160	...	TA2160	...	TA2160	...	TA2160	...	TA2160	...	TA2160		
...	TA1260	...	TA2160	...	TA2160	...	TA2160	...	TA2160	...	TA2160	...	TA2160	...	TA2160		

● External Stations POWERED FROM THE BUS with Digital Encoder (PE)

series AGORA'			series ALBA		
...	VD2101AGL-AD2101AGL (1)	...	CV2124AB-CA2124AB (1)	...	AB61-AB63
...	AGL21	...	CT2138AB	...	AB71-AB73
...	AGL20	...	AB21	...	EC733
...		...	AB20	...	
...		...	AB00-AB50	...	
...		...	SC1÷SC3	...	
...		...	AB91÷AB96 (2)	...	

● External Stations POWERED FROM THE BUS with Digital Keyboard (PE)

series SOLVO

...	TD2000-TD2000R-TD2000A-TD2000RA (1)
...	FP2000
...	290S/0 (2)

● External Stations TRADITIONAL with Digital Encoder (PE)

series AGORA'		series PROFILO		series MATRIX	
...	VD2121CAG(L)-AD2121CAG(L) (1)	...	VD2120CPL-AD2120CPL	...	VD2120CMAS-AD2110MAS
...	AG100TS-AGL100TS (1)	...	CD2131PL÷CD2138PL (1)	...	CD2131MAS÷CD2134MAS (1)
...	AG21-AGL21	...	PL24S-PL228S (1)	...	MAS24S (1)
...	AG20-AGL20	...	PL20-PL50	...	MAS20
...	2220S	...	PL72-PL73	...	MA72-MA73
...	PRS210	...	PL82÷PL89	...	MAS62-MAS63
...		...	PL92÷PL99 (2)	...	MA92-MA93 (2)
...		...	2220S	...	2220S
...		...	PRS210	...	PRS210

● External Stations TRADITIONAL with Digital Keyboard (PE)

series PROFILO		series MATRIX	
...	VD2120CPL-AD2120CPL	...	VD2120CMAS-AD2110MAS
...	TD2100PL (1)	...	TD2100MAS (1)
...	PL72	...	MA72
...	PL82	...	MAS62
...	PL92 (2)	...	MA92 (2)
...	2220S	...	2220S

● Other Articles

...	DV2421Q	Video distributor with 1 output
...	DV2424Q	Video distributor with 4 outputs
...	DV2422A (1)	Active video distributor with 2 outputs
...	2231Q (1)	Line buffer
...	2221MQ - 2221S	Line power supply
...	DV2420	Line distributor
...	FP (3)	Floor push button (optional)
...	PA (3)	Door release button (optional)
...	SE (3)	Electrical door lock(12Vac-1A)

... According to the number of users and external stations

(1) Articles to be programmed

(2) Rain shelters are used in replacement of back boxes.

(3) Articles not supplied by ACI Farfisa.

Installation notes.

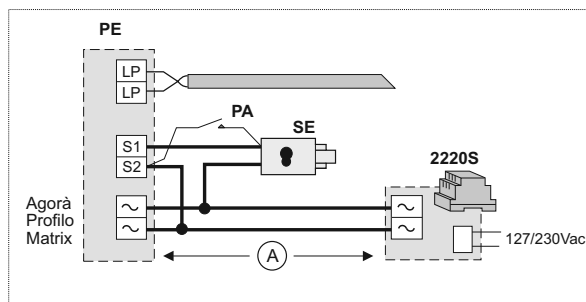
- For maximum users number see table 5.1.

- For the choos and cross section and installation of the wires see table 5.3.

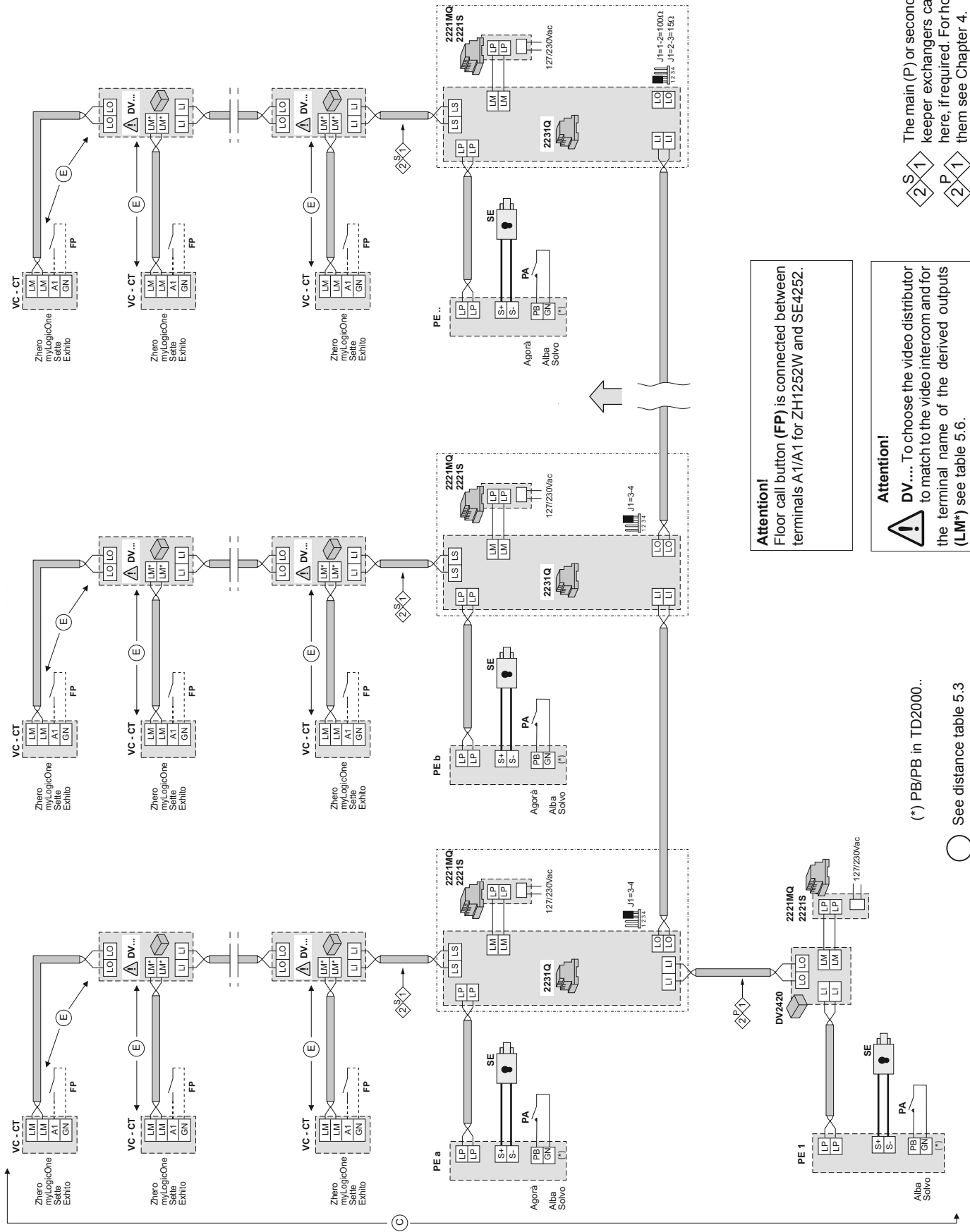
- For the correct operation of the system, jumper **J1** of all the video distributors must be left in position **2-3** (open line). The line impedance is determined by the video intercom connected to the **LO** output of the last video distributor; if this output is not connected close it by positioning jumper **J1** appropriately. The line must not remain open.

- We recommend to install all articles framed with a broken line in the same switchboard.

- Using TRADITIONAL (only SECONDARY in case of extended range) external stations (with 2220S), apply the diagram below:



**MULTI-WAY SYSTEM CONNECTED TO 1 AUDIO-VIDEO MAIN COMMON DOOR STATION AND DIVISION IN MORE RISERS WITH EACH 1 AUDIO-VIDEO SECONDARY DOOR STATION (staircase division). Applicable with Extended Range Duo.**



**Attention!**  
Floor call button (FP) is connected between terminals A1/A1 for ZH1252W and SE4252.

**Attention!**  
DV ... To choose the video distributor to match to the video intercom and for the terminal name of the derived outputs (LM\*) see table 5.6.

(\*) PB/PB in TD2000..  
See distance table 5.3

The main (P) or secondary (S) door-keeper exchangers can be applied here, if required. For how to connect them see Chapter 4.



## MULTI-WAY SYSTEM CONNECTED TO 1 AUDIO-VIDEO MAIN COMMON DOOR STATION AND DIVISION IN MORE DIFFERENT RISERS WITH EACH 1 AUDIO-VIDEO SECONDARY DOOR STATION (*staircase division*)

### ● Internal Stations: VIDEOINTERCOMS (VC)

● Internal Stations: VIDEOINTERCOMS (VC)			● INTERCOMS (CT)		
<b>series ZHERO</b>	<b>myLogicOne</b>	<b>SETTE</b>	<b>EXHITO</b>	<b>EXHITO</b>	<b>EXHITO</b>
... ZH1262B (1)	... ML2002C (1)	... SE4252 (1)	... EX3262C (1)	... EX3252C (1)	... EX352 (1)
... ZH1262W (1)	... ML2083		... WB3262	... WB3252 (1)	... EX362 (1)
... ZH1252W (1)	... WA2160W		... TA3160	... TA3160	... TA320
... TA1260	... TA2160				

### ● External Stations POWERED FROM THE BUS with Digital Encoder (PE)

<b>series AGORA'</b>	<b>series ALBA</b>
... VD2101AGL-AD2101AGL (1)	... CV2124AB-CA2124AB (1)
... AGL21	... CT2138AB
... AGL20	... AB21
	... AB20
	... AB00-AB50
	... SC1÷SC3
	... AB91÷AB96 (2)
	... AB61-AB63
	... AB71-AB73
	... EC733

### ● External Stations POWERED FROM THE BUS with Digital Keyboard (PE)

#### series SOLVO

... TD2000-TD2000R-TD2000A-TD2000RA (1)
... FP2000
... 290S/0 (2)

### ● External Stations TRADITIONAL with Digital Encoder (PE)

<b>series AGORA'</b>	<b>series PROFILO</b>	<b>series MATRIX</b>
... VD2121CAG(L)-AD2121CAG(L) (1)	... VD2120CPL-AD2120CPL	... VD2120CMAS-AD2110MAS
... AG100TS-AGL100TS (1)	... CD2131PL÷CD2138PL (1)	... CD2131MAS÷CD2134MAS (1)
... AG21-AGL21	... PL24S-PL228S (1)	... MAS24S (1)
... AG20-AGL20	... PL20-PL50	... MAS20
... 2220S	... PL72-PL73	... MA72-MA73
... PRS210	... PL82÷PL89	... MAS62-MAS63
	... PL92÷PL99 (2)	... MA92-MA93 (2)
	... 2220S	... 2220S
	... PRS210	... PRS210

### ● External Stations TRADITIONAL with Digital Keyboard (PE)

<b>series PROFILO</b>	<b>series MATRIX</b>
... VD2120CPL-AD2120CPL	... VD2120CMAS-AD2110MAS
... TD2100PL (1)	... TD2100MAS (1)
... PL72	... MA72
... PL82	... MAS62
... PL92 (2)	... MA92 (2)
... 2220S	... 2220S

### ● Other Articles

... DV2421Q	Video distributor with 1 output
... DV2424Q	Video distributor with 4 outputs
... DV2422A (1)	Active video distributor with 2 outputs
... 2231Q (1)	Line buffer
... DM2421 (1)	Line distributor
... 2221MQ - 2221S	Line power supply
... DV2420	Line distributor
... FP (3)	Floor push button ( <i>optional</i> )
... PA (3)	Door release button ( <i>optional</i> )
... SE (3)	Electrical door lock(12Vac-1A)

... According to the number of users and external stations

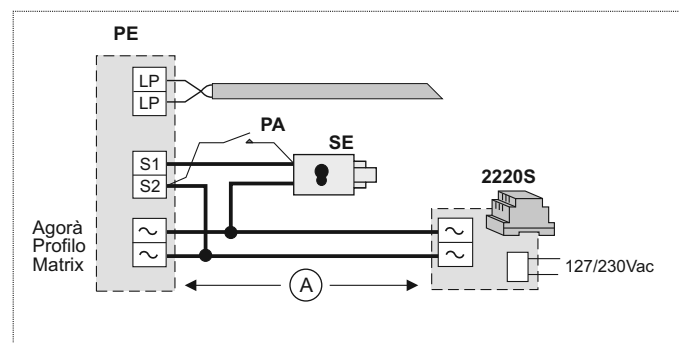
(1) Articles to be programmed

(2) Rain shelters are used in replacement of back boxes.

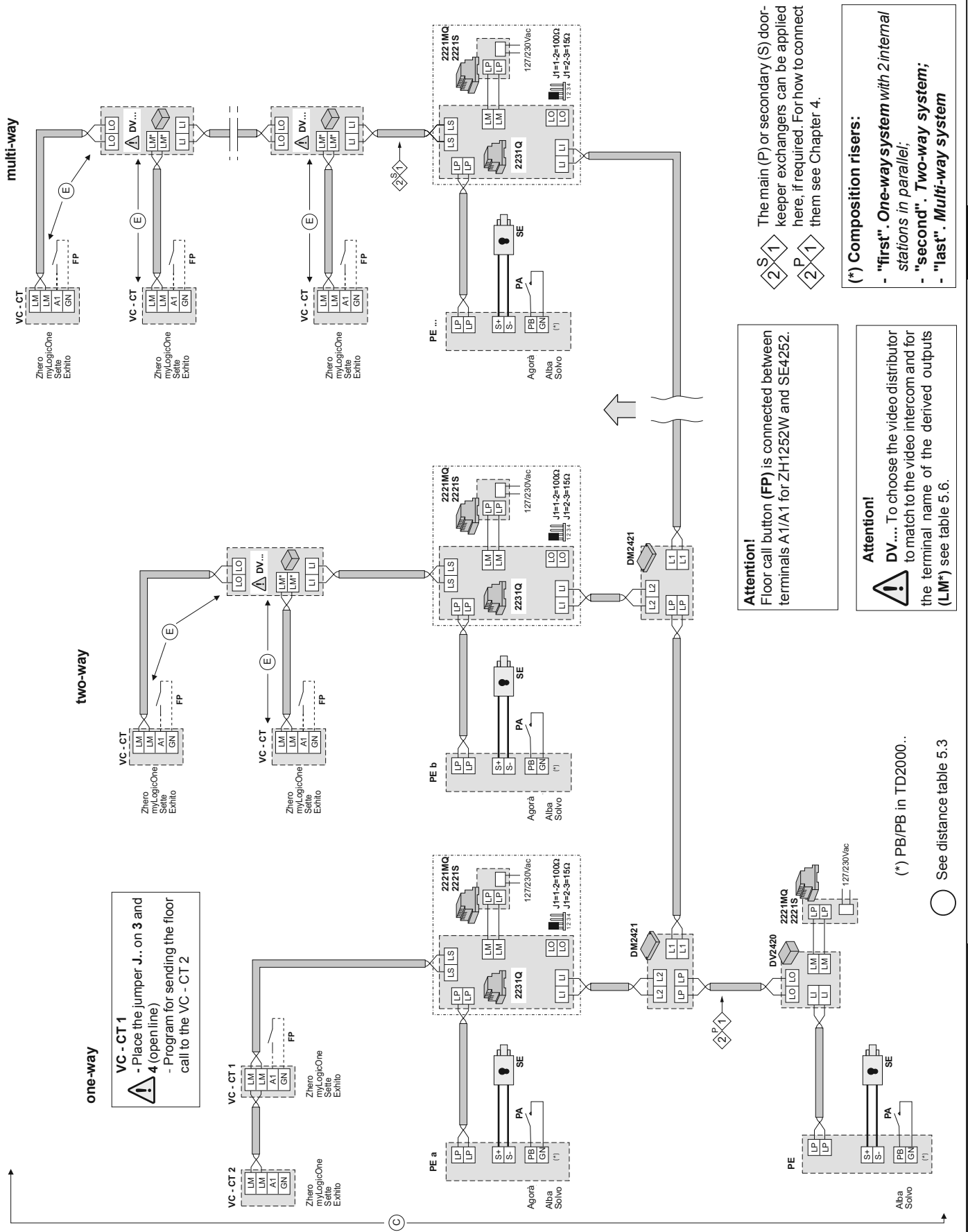
(3) Articles not supplied by ACI Farfisa.

### Installation notes.

- For maximum users number see table 5.1.
- For the choos and cross section and installation of the wires see table 5.3.
- For the correct operation of the system, jumper **J1** of all the video distributors must be left in position **2-3** (open line). The line impedance is determined by the video intercom connected to the **LO** output of the last video distributor; if this output is not connected close it by positioning jumper **J1** appropriately. The line must not remain open.
- We recommend to install all articles framed with a broken line in the same switchboard.
- Using TRADITIONAL external stations (with 2220S), apply the diagram below:



MULTI-WAY SYSTEM CONNECTED TO 1 AUDIO-VIDEO MAIN COMMON DOOR STATION AND DIVISION IN MORE DIFFERENT RISERS (\*) WITH EACH 1 AUDIO-VIDEO SECONDARY DOOR STATION (staircase division)



multi-way

two-way

one-way

**VC - CT 1**  
 - Place the jumper J.. on 3 and 4 (open line)  
 - Program for sending the floor call to the VC - CT 2

**Attention!**  
 Floor call button (FP) is connected between terminals A1/A1 for ZH1252W and SE4252.

**Attention!**  
 DV ... To choose the video distributor to match to the video intercom and for the terminal name of the derived outputs (LM\*) see table 5.6.

The main (P) or secondary (S) door-keeper exchangers can be applied here, if required. For how to connect them see Chapter 4.

(\*) Composition risers:  
 - "first". One-way system with 2 internal stations in parallel;  
 - "second". Two-way system;  
 - "last". Multi-way system

(\*) PB/PB in TD2000 ..  
 See distance table 5.3

## MULTI-WAY SYSTEM CONNECTED TO MAX 4 AUDIO-VIDEO MAIN COMMON DOOR STATIONS AND DIVISION IN MAX 4 RISERS WITH EACH 1 AUDIO-VIDEO SECONDARY DOOR STATION (*staircase division*)

### ● Internal Stations: VIDEOINTERCOMS (VC)

● Internal Stations: VIDEOINTERCOMS (VC)			● INTERCOMS (CT)		
<b>series ZHERO</b>	<b>myLogicOne</b>	<b>SETTE</b>	<b>EXHITO</b>	<b>EXHITO</b>	<b>EXHITO</b>
... ZH1262B <sup>(1)</sup>	... ML2002C <sup>(1)</sup>	... SE4252 <sup>(1)</sup>	... EX3262C <sup>(1)</sup>	... EX3252C <sup>(1)</sup>	... EX352 <sup>(1)</sup>
... ZH1262W <sup>(1)</sup>	... ML2083		... WB3262	... WB3252 <sup>(1)</sup>	... EX362 <sup>(1)</sup>
... ZH1252W <sup>(1)</sup>	... WA2160W		... TA3160	... TA3160	... TA320
... TA1260	... TA2160				

### ● External Stations POWERED FROM THE BUS with Digital Encoder (PE)

<b>series AGORA'</b>	<b>series ALBA</b>
... VD2101AGL-AD2101AGL <sup>(1)</sup>	... CV2124AB-CA2124AB <sup>(1)</sup>
... AGL21	... CT2138AB
... AGL20	... AB21
	... AB20
	... AB00-AB50
	... SC1÷SC3
	... AB91÷AB96 <sup>(2)</sup>
	... AB61-AB63
	... AB71-AB73
	... EC733

### ● External Stations POWERED FROM THE BUS with Digital Keyboard (PE)

#### series SOLVO

... TD2000-TD2000R-TD2000A-TD2000RA <sup>(1)</sup>
... FP2000
... 290S/0 <sup>(2)</sup>

### ● External Stations TRADITIONAL with Digital Encoder (PE)

<b>series AGORA'</b>	<b>series PROFILO</b>	<b>series MATRIX</b>
... VD2121CAG(L)-AD2121CAG(L) <sup>(1)</sup>	... VD2120CPL-AD2120CPL	... VD2120CMAS-AD2110MAS
... AG100TS-AGL100TS <sup>(1)</sup>	... CD2131PL÷CD2138PL <sup>(1)</sup>	... CD2131MAS÷CD2134MAS <sup>(1)</sup>
... AG21-AGL21	... PL24S-PL228S <sup>(1)</sup>	... MAS24S <sup>(1)</sup>
... AG20-AGL20	... PL20-PL50	... MAS20
... 2220S	... PL72-PL73	... MA72-MA73
... PRS210	... PL82÷PL89	... MAS62-MAS63
	... PL92÷PL99 <sup>(2)</sup>	... MA92-MA93 <sup>(2)</sup>
	... 2220S	... 2220S
	... PRS210	... PRS210

### ● External Stations TRADITIONAL with Digital Keyboard (PE)

<b>series PROFILO</b>	<b>series MATRIX</b>
... VD2120CPL-AD2120CPL	... VD2120CMAS-AD2110MAS
... TD2100PL <sup>(1)</sup>	... TD2100MAS <sup>(1)</sup>
... PL72	... MA72
... PL82	... MAS62
... PL92 <sup>(2)</sup>	... MA92 <sup>(2)</sup>
... 2220S	... 2220S

### ● Other Articles

... DV2421Q	Video distributor with 1 output
... DV2424Q	Video distributor with 4 outputs
... DV2422A <sup>(1)</sup>	Active video distributor with 2 outputs
... 2231Q <sup>(1)</sup>	Line buffer
... DM2444 <sup>(1)</sup>	4 IN/4 OUTPUT line distributor
... 2221MQ - 2221S	Line power supply
... DV2420	Line distributor
... FP <sup>(3)</sup>	Floor push button ( <i>optional</i> )
... PA <sup>(3)</sup>	Door release button ( <i>optional</i> )
... SE <sup>(3)</sup>	Electrical door lock(12Vac-1A)

... According to the number of users and external stations

<sup>(1)</sup> Articles to be programmed

<sup>(2)</sup> Rain shelters are used in replacement of back boxes.

<sup>(3)</sup> Articles not supplied by ACI Farfisa.

#### Installation notes.

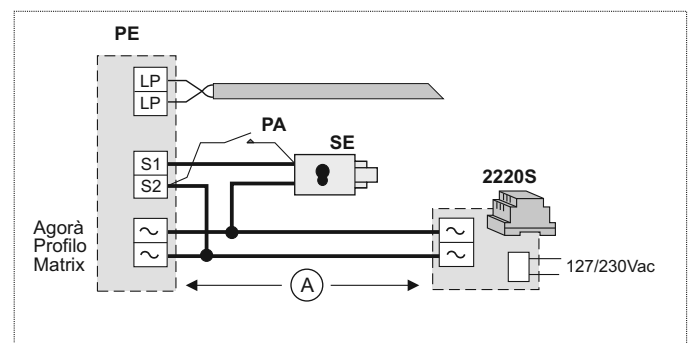
- For maximum users number see table 5.1.

- For the choos and cross section and installation of the wires see table 5.3.

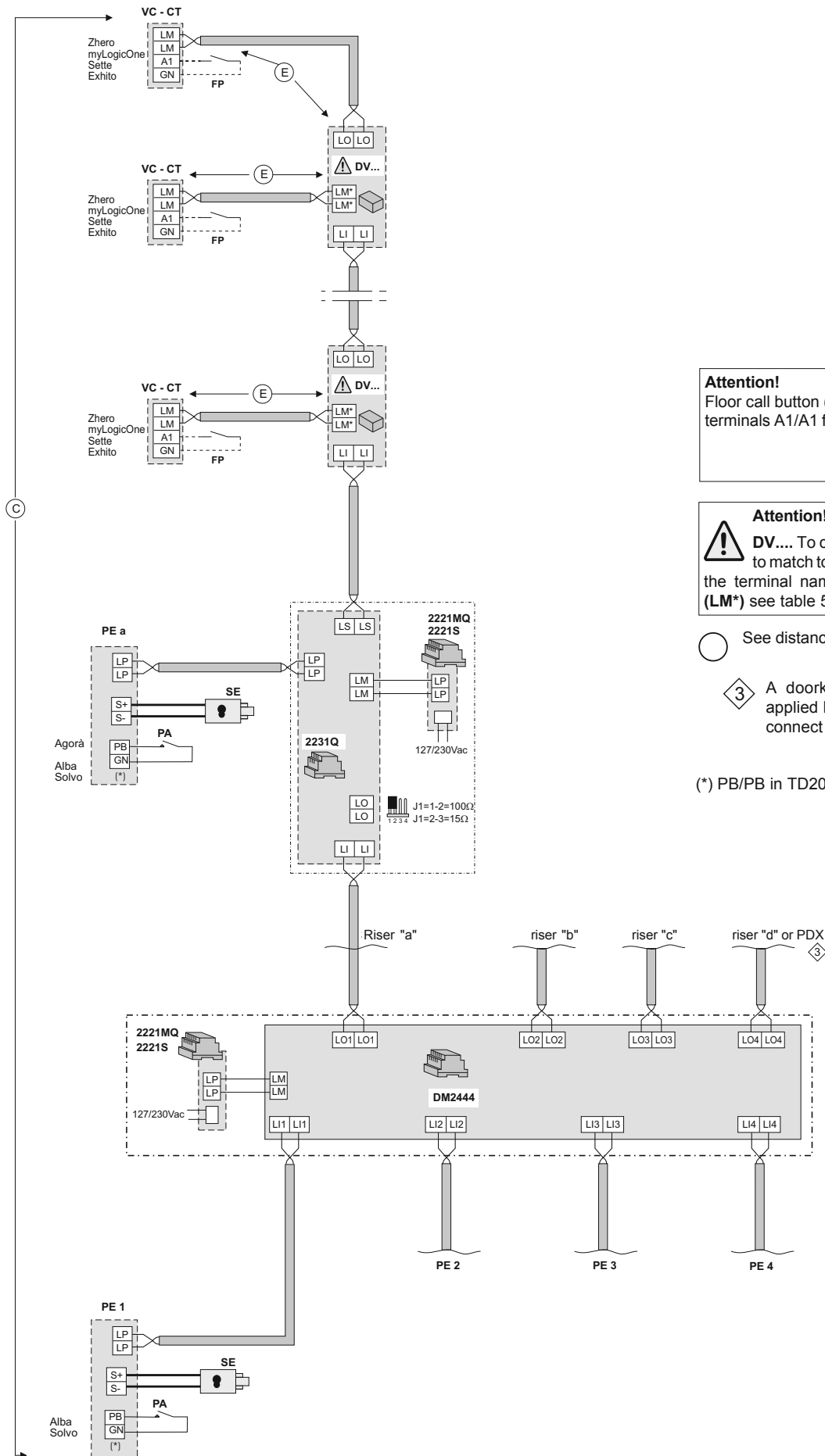
- For the correct operation of the system, jumper **J1** of all the video distributors must be left in position **2-3** (open line). The line impedance is determined by the video intercom connected to the **LO** output of the last video distributor; if this output is not connected close it by positioning jumper **J1** appropriately. The line must not remain open.

- We recommend to install all articles framed with a broken line in the same switchboard.

- Using TRADITIONAL external stations (with 2220S), apply the diagram below:



**MULTI-WAY SYSTEM CONNECTED TO MAX 4 AUDIO-VIDEO MAIN COMMON DOOR STATIONS AND DIVISION IN MAX 4 RISERS WITH EACH 1 AUDIO-VIDEO SECONDARY DOOR STATION (staircase division)**



**Attention!**  
Floor call button (FP) is connected between terminals A1/A1 for ZH1252W and SE4252.

**Attention!**  
⚠ DV.... To choose the video distributor to match to the video intercom and for the terminal name of the derived outputs (LM\*) see table 5.6.

○ See distance table 5.3

◇ 3 A doorkeeper exchanger can be applied here if required. For how to connect it see Chapter 4.

(\*) PB/PB in TD2000..

## MULTI-WAY INTERCOM SYSTEM CONNECTED TO 1 OR MORE DOOR STATIONS

## ● Internal Stations: INTERCOMS (CT)

## series EXHITO

... EX352 <sup>(1)</sup>  
 ... EX362 <sup>(1)</sup>  
 ... TA320

## ● External Stations POWERED FROM THE BUS with Digital Encoder (PE)

## series AGORA'

... AD2101AGL <sup>(1)</sup>  
 ... AGL21  
 ... AGL20

## series ALBA

... CA2124AB <sup>(1)</sup>      ... AB61-AB63  
 ... CT2138AB      ... AB71-AB73  
 ... AB21      ... EC733  
 ... AB20  
 ... AB00-AB50  
 ... SC1÷SC3  
 ... AB91÷AB96 <sup>(2)</sup>

## ● External Stations POWERED FROM THE BUS with Digital Keyboard (PE)

## series SOLVO

... TD2000A-TD2000RA <sup>(1)</sup>  
 ... FP2000  
 ... 290S/0 <sup>(2)</sup>

## ● External Stations TRADITIONAL with Digital Encoder (PE)

## series AGORA'

... AD2121CAG(L) <sup>(1)</sup>  
 ... AG100TS-AGL100TS <sup>(1)</sup>  
 ... AG21-AGL21  
 ... AG20-AGL20  
 ... 2220S  
 ... PRS210

## series PROFILO

... AD2120CPL  
 ... CD2131PL÷CD2138PL <sup>(1)</sup>  
 ... PL24S-PL228S <sup>(1)</sup>  
 ... PL20-PL50  
 ... PL72-PL73  
 ... PL82÷PL89  
 ... PL92÷PL99 <sup>(2)</sup>  
 ... 2220S  
 ... PRS210

## series MATRIX

... AD2110MAS  
 ... CD2131MAS÷CD2134MAS <sup>(1)</sup>  
 ... MAS24S <sup>(1)</sup>  
 ... MAS20  
 ... MA72-MA73  
 ... MAS62-MAS63  
 ... MA92-MA93 <sup>(2)</sup>  
 ... 2220S  
 ... PRS210

## ● External Stations TRADITIONAL with Digital Keyboard (PE)

## series PROFILO

... AD2120CPL  
 ... TD2100PL <sup>(1)</sup>  
 ... PL72  
 ... PL82  
 ... PL92 <sup>(2)</sup>  
 ... 2220S

## series MATRIX

... AD2110MAS  
 ... TD2100MAS <sup>(1)</sup>  
 ... MA72  
 ... MAS62  
 ... MA92 <sup>(2)</sup>  
 ... 2220S

## ● Other Articles

... 2221MQ - 2221S Line power supply  
 ... DV2420 Line distributor (see page 5.10)  
 ... FP <sup>(3)</sup> Floor push button (optional)  
 ... PA <sup>(3)</sup> Door release button (optional)  
 ... SE <sup>(3)</sup> Electrical door lock(12Vac-1A)

... According to the number of users and external stations

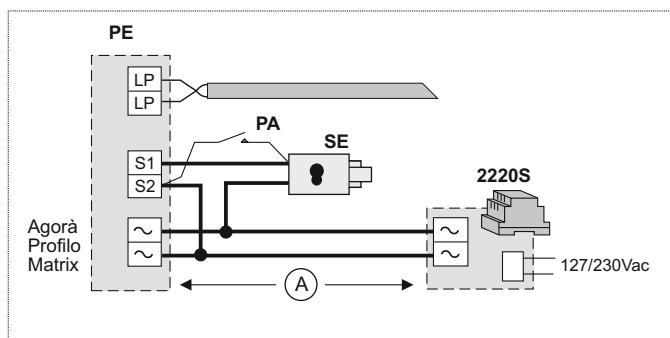
<sup>(1)</sup> Articles to be programmed

<sup>(2)</sup> Rain shelters are used in replacement of back boxes.

<sup>(3)</sup> Articles not supplied by ACI Farfisa.

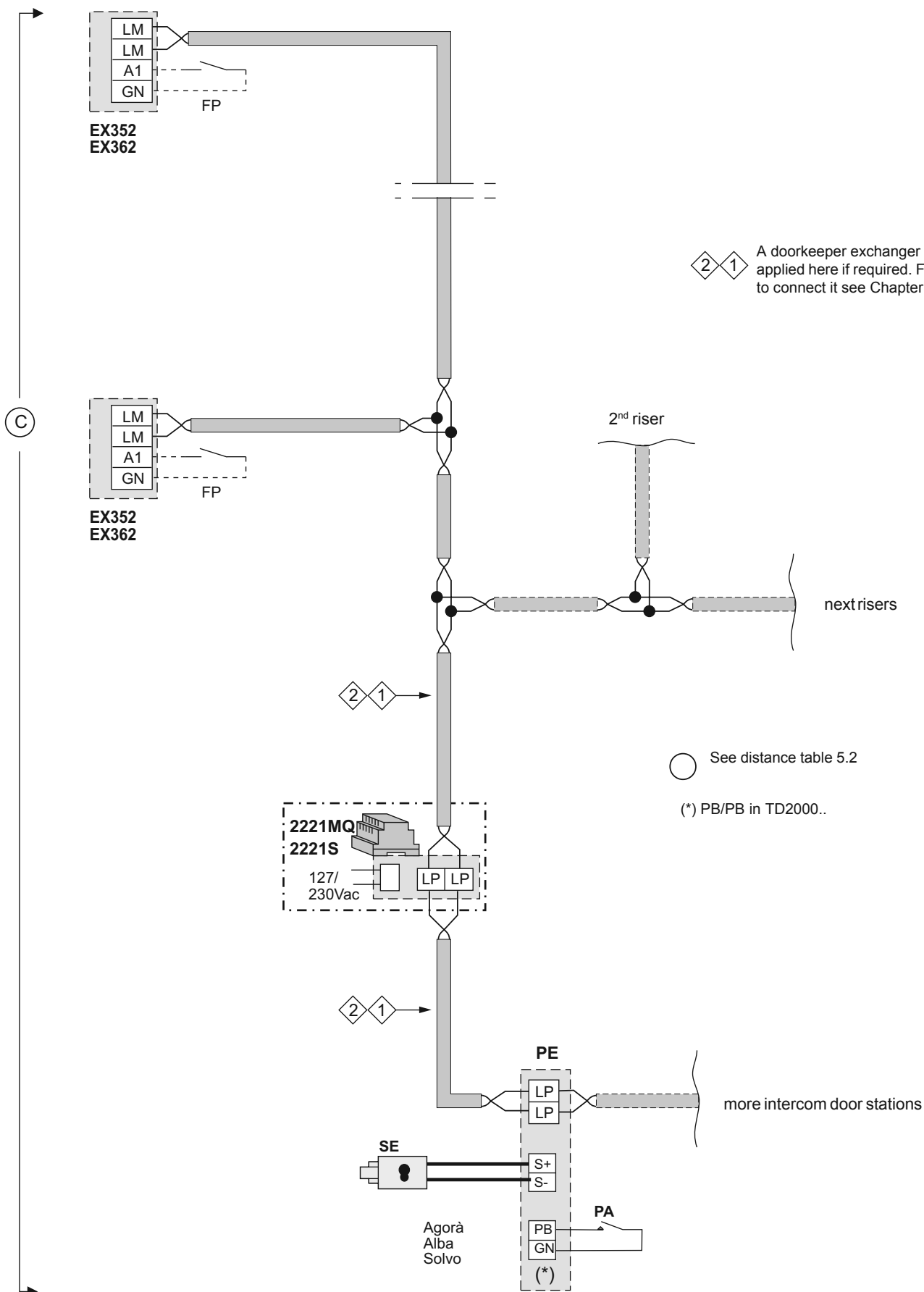
## Installation notes.

- For maximum users number see table 5.1.
- For the choos and cross section and installation of the wires see table 5.2.
- We recommend to install all articles framed with a broken line in the same switchboard.
- Using TRADITIONAL external stations (with 2220S), apply the diagram below:





MULTI-WAY INTERCOM SYSTEM CONNECTED TO 1 OR MORE DOOR STATIONS



2 1 A doorkeeper exchanger can be applied here if required. For how to connect it see Chapter 4.

○ See distance table 5.2

(\* PB/PB in TD2000..)

## MULTI-WAY INTERCOM SYSTEM CONNECTED TO SECONDARY DOOR STATIONS AND MORE MAIN DOOR STATIONS *(staircase division)*. Applicable with *Extended Range Duo*

### ● Internal Stations: INTERCOMS (CT)

#### series EXHITO

... EX352 <sup>(1)</sup>  
 ... EX362 <sup>(1)</sup>  
 ... TA320

### ● External Stations POWERED FROM THE BUS with Digital Encoder (PE)

#### series AGORA'

... AD2101AGL <sup>(1)</sup>  
 ... AGL21  
 ... AGL20

#### series ALBA

... CA2124AB <sup>(1)</sup>      ... AB61-AB63  
 ... CT2138AB      ... AB71-AB73  
 ... AB21      ... EC733  
 ... AB20  
 ... AB00-AB50  
 ... SC1+SC3  
 ... AB91+AB96 <sup>(2)</sup>

### ● External Stations POWERED FROM THE BUS with Digital Keyboard (PE)

#### series SOLVO

... TD2000A-TD2000RA <sup>(1)</sup>  
 ... FP2000  
 ... 290S/0 <sup>(2)</sup>

### ● External Stations TRADITIONAL with Digital Encoder (PE)

#### series AGORA'

... AD2121CAG(L) <sup>(1)</sup>  
 ... AG100TS-AGL100TS <sup>(1)</sup>  
 ... AG21-AGL21  
 ... AG20-AGL20  
 ... 2220S  
 ... PRS210

#### series PROFILO

... AD2120CPL  
 ... CD2131PL+CD2138PL <sup>(1)</sup>  
 ... PL24S-PL228S <sup>(1)</sup>  
 ... PL20-PL50  
 ... PL72-PL73  
 ... PL82+PL89  
 ... PL92+PL99 <sup>(2)</sup>  
 ... 2220S  
 ... PRS210

#### series MATRIX

... AD2110MAS  
 ... CD2131MAS+CD2134MAS <sup>(1)</sup>  
 ... MAS24S <sup>(1)</sup>  
 ... MAS20  
 ... MA72-MA73  
 ... MAS62-MAS63  
 ... MA92-MA93 <sup>(2)</sup>  
 ... 2220S  
 ... PRS210

### ● External Stations TRADITIONAL with Digital Keyboard (PE)

#### series PROFILO

... AD2120CPL  
 ... TD2100PL <sup>(1)</sup>  
 ... PL72  
 ... PL82  
 ... PL92 <sup>(2)</sup>  
 ... 2220S

#### series MATRIX

... AD2110MAS  
 ... TD2100MAS <sup>(1)</sup>  
 ... MA72  
 ... MAS62  
 ... MA92 <sup>(2)</sup>  
 ... 2220S

### ● Other Articles

... 2231Q <sup>(1)</sup>      Line buffer  
 ... 2221MQ - 2221S      Line power supply  
 ... DV2420      Line distributor  
 ... FP <sup>(3)</sup>      Floor push button *(optional)*  
 ... PA <sup>(3)</sup>      Door release button *(optional)*  
 ... SE <sup>(3)</sup>      Electrical door lock(12Vac-1A)

... According to the number of users and external stations

<sup>(1)</sup> Articles to be programmed

<sup>(2)</sup> Rain shelters are used in replacement of back boxes.

<sup>(3)</sup> Articles not supplied by ACI Farfisa.

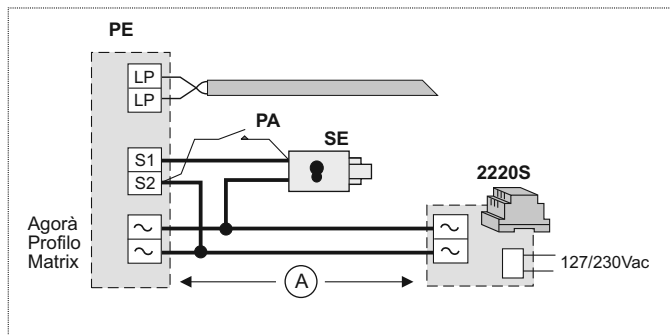
### Installation notes.

- For maximum users number see table 5.1.

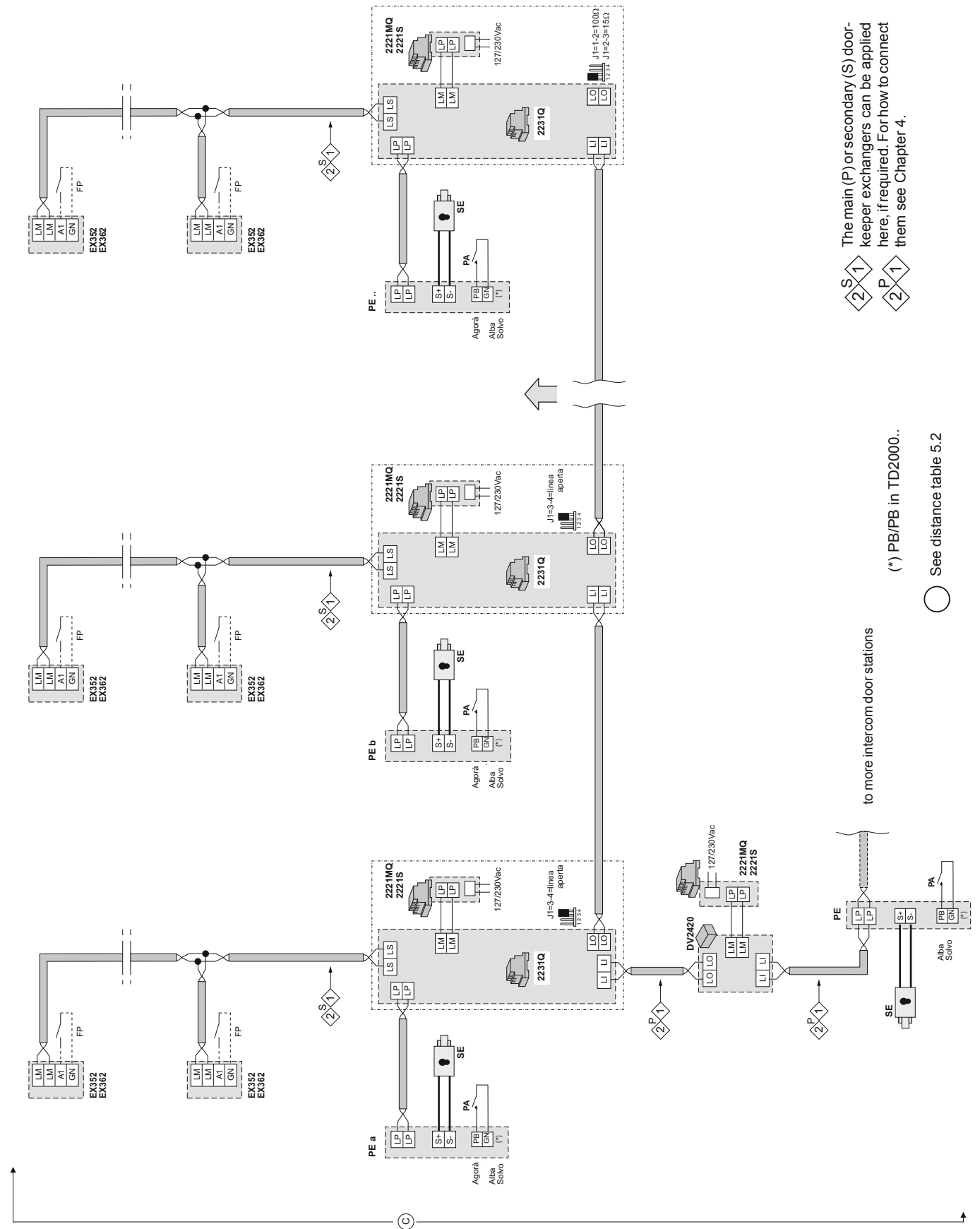
- For the choos and cross section and installation of the wires see table 5.2.

- We recommend to install all articles framed with a broken line in the same switchboard.

- Using TRADITIONAL external stations (with 2220S), apply the diagram below:



MULTI-WAY INTERCOM SYSTEM CONNECTED TO SECONDARY DOOR STATIONS AND MORE MAIN DOOR STATIONS (staircase division). Applicable with Extended Range Duo



 The main (P) or secondary (S) door-keeper exchangers can be applied here, if required. For how to connect them see Chapter 4.

(\*) PB/PB in TD2000..

○ See distance table 5.2

to more intercom door stations

Article	Description
2220S.	Transformer for door stations
2221MQ.	Line power supply
2221S.	Line power supply
2223Q.	Colour video amplifier
2231Q.	Line buffer
2281Q.	Actuator module for services
2287.	4 or 7 exchange selector
2302-2302E.	Cable with 2 conductors
290S/0.	Rain shelter for Solvo series push buttons
AB00.	Blank modulo for Alba series
AB20.	Cover for Alba series
AB21.	Button module for Alba series
AB50.	Number module for Alba series
AB61.	One module front frame for Alba series
AB62.	Two module front frame for Alba series
AB63.	Three module front frame for Alba series
AB71.	Module frame for one module for Alba series
AB72.	Module frame for two modules for Alba series
AB73.	Module frame for three modules for Alba series
AB81S.	Box for surface mounting one module for Alba series
AB82S.	Box for surface mounting two modules for Alba series
AB83S.	Box for surface mounting three modules for Alba series
AB91.	Rain shelter one module for Alba series
AB92.	Rain shelter two modules for Alba series
AB93.	Rain shelter three modules for Alba series
AB94.	Rain shelter four modules for Alba series
AB96.	Rain shelter six modules for Alba series
AD2101AGL.	Powered from the bus audio door station Agorà series
AD2110MAS.	Audio module for Matrix series
AD2120CPL.	Audio module for colour installations. Profilo series
AD2121CAG/L.	Intercom door station series Agorà
AG100TS.	Push-button door station series Agorà
AGL100TS.	Push-button door station series Agorà
AG20.	Blank module series Agorà
AGL20.	Blank module series Agorà
AG21.	Single button module series Agorà
AGL21.	Single button module series Agorà
CA2124AB.	Audio module with 4 calla Alba seires
CD2131MAS.	Encoder module with 2 call buttons. Series Matrix
CD2131PL.	Encoder module with 1 call button. Profilo
CD2132MAS.	Encoder module with 2 call buttons. Series Matrix
CD2132PL.	Encoder module with 2 call buttons. Series Profilo
CD2134MAS.	Encoder module with 4 call buttons. Series Matrix
CD2134PL.	Encoder module with 4 call buttons. Series Profilo
CD2138PL.	Encoder module with 8 call buttons. Series Profilo
CT2138AB.	Additional buttons module 8 calls for Alba series
CV2124AB.	Video module with 4 calls Alba series
DM2421.	Distributor of riser
DV2420.	Line distributor
DV2421Q.	Video distributor with 1 output
DV2422A.	Active distributor with 2 outputs
DV2424Q.	Video distributor with 4 outputs
DM2444.	4-inputs and 4 outputs line distributor
EC733.	Cable for connection of Alba modules lenght 56 cm
EX3252C.	Colour video intercom with 3 buttons, series Exhito
EX3262C.	Colour video intercom with 7 buttons, series Exhito
EX352.	Intercom with 3 buttons, series Exhito
EX362.	Intercom with 8 buttons, series Exhito
FP2000.	RFID PCB module for Solvo panel
MAS20.	Blank module series Matrix
MAS24S.	Module with 4 call buttons. Series Matrix

Article	Description
MAS61.	Front frame for 1 module. Matrix series
MAS62.	Front frame for 2 modules. Matrix series
MAS63.	Front frame for 3 modules. Matrix series
MA71.	Back box with frame for 1 module. Matrix series
MA72.	Back box with frame for 2 modules. Matrix series
MA73.	Back box with frame for 3 modules. Matrix series
MA91.	Rain shelter with frame for 1 module. Matrix series
MA92.	Rain shelter with frame for 2 modules. Matrix series
MA93.	Rain shelter with frame for 3 modules. Matrix series
ML2002C.	Colour video intercom with OSD screen; series myLogic
ML2083.	Back box for videointercom ML2002C
PDX2000.	Doorkeeper exchanger
PGR2990.	Duo programmer
PL20.	Blank module. Series Profilo
PL24S.	Module with 4 call buttons. Series Profilo
PL50.	Number module. Series Profilo
PL228S.	Module with 8 call buttons. Series Profilo
PL71.	Back box with frame for 1 module. Profilo series
PL72.	Back box with frame for 2 modules. Profilo series
PL73.	Back box with frame for 3 modules. Profilo series
PL81.	Hood cover for 1 module. Profilo series
PL82.	Hood cover for 2 modules. Profilo series
PL83.	Hood cover for 3 modules. Profilo series
PL84.	Hood cover for 4 modules. Profilo series
PL86.	Hood cover for 6 modules. Profilo series
PL89.	Hood cover for 9 modules. Profilo series
PL91.	Rain shelter with frame for 1 module. Profilo series
PL92.	Rain shelter with frame for 2 modules. Profilo series
PL93.	Rain shelter with frame for 3 modules. Profilo series
PL94.	Rain shelter with frame for 4 modules. Profilo series
PL96.	Rain shelter with frame for 6 modules. Profilo series
PL99.	Rain shelter with frame for 9 modules. Profilo series
PRS210.	Transformer 13Vac-15VA
SE400.	Handset for Sette videointercom
SE4252.	Videointercom 7" Sette series
ST7100CW.	Colour monitor for doorkeeper exchanger
TA320.	Table adapter for intercoms series Exhito
TA1260.	Table adapter for videointercoms Zhero and myLogic
TA2160.	Table adapter for videointercoms series myLogic
TA3160.	Table adapter for videointercoms series Exhito
TA7100W.	Table adapter for monitor ST7100CW
TD2000.	Solvo door panel
TD2000A.	Solvo door panel only audio
TD2000R.	Solvo door panel RFID
TD2000RA.	Solvo door panel RFID only audio
TD2100MAS.	Digital push-button panel module. Matrix series
TD2100PL.	Digital push-button panel module. Profilo series
VD2101AGL.	Powered from the bus A/V door station Agorà series
VD2120CMAS.	Colour audio/video module. Matrix series
VD2120CPL.	Colour audio/video module. Profilo series
VD2121CAG/L.	Videointercom door station. Agorà series
VM2521.	Video modulator
WA2160W.	Wall adaptor for ML2002C videointercom
WB3252.	Wall bracket for EX3252 videointercom
WB3262.	Wall bracket for EX3262 and EX3262C videointercoms
WB7260.	Wall bracket for ST7100CW videointercom
XT2928U.	Encoding board for analog panels
ZH1252W.	Colour video intercom series Zhero S
ZH1262B.	Colour video intercom with OSD screen; series Zhero
ZH1262W.	Colour video intercom with OSD screen; series Zhero

Due to continuous technological evolution ACI FARFISA reserves the right to modify the products, technical specifications and installation diagrams contained in this manual at any time without prior notice.

The diagrams and information contained in this manual have been carefully verified and are to be considered as reliable. However, ACI FARFISA is not responsible for any errors, inaccuracies or infringements to patents and third-party rights that may arise from using this manual.

13

 **FARFISA**

ACI srl  
via E. Vanoni, 3  
60027 Osimo (AN) Italy  
tel. (+39) 071.7202038  
fax (+39) 071.7202037  
[www.farfisa.com](http://www.farfisa.com)  
[info@farfisa.com](mailto:info@farfisa.com)

ENGLISH